



Fly Catalogue

KI

O

U

R

T

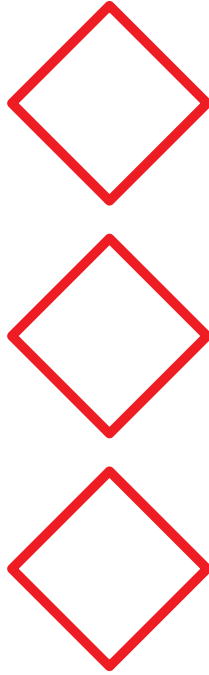

TRUCK

Design

Truck Design S.R.L.

FLY CATALOGUE

FIRST VERSION
- July 2022 -

◇ WATER TANKS AND ACCESSORIES	04 · 12
◇ DOCUMENT HOLDER	19
◇ PALLET BOX	22
◇ BRACKETS FOR TOOLBOXES AND WATER TANKS	23 · 25
◇ BUMPER BAR	26 · 33
◇ PROTECTIVE GRILLS "BLACKLINE"	36 · 37
◇ MUDGUARDS AND ACCESSORIES	38 · 50
◇ LADDERS	51 · 53
◇ BODY MOUNTING BRACKETS	54
◇ BRACKETS FOR SIDEGUARDS	55
◇ SPOILER	56 · 58
◇ MUDFLAPS	59 · 68
◇ COMPOSITION OF A.D.R. AND STICKERS	69 · 72

WATER TANKS



ORIGINAL Plastic water tank 25 lt. with galvanized support

Tanica acqua ORIGINAL 25 lt. con supporto zincato

ARTICLE	L	H	P	KG	N.
T962/Z	225	450	600	5,60	40

TKcert RINA UNI EN ISO 15614-1:2012

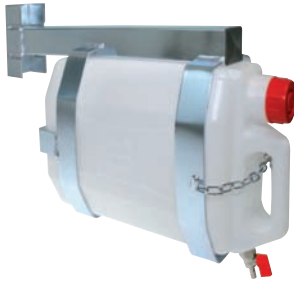
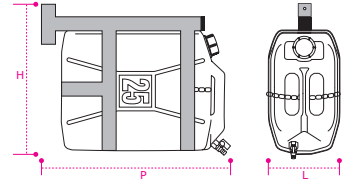

ORIGINAL Plastic water tank 10 lt. with galvanized support

Tanica acqua ORIGINAL 10 lt. con supporto zincato

ARTICLE	L	H	P	KG	N.
T966/Z	175	380	480	4,20	50

TKcert RINA UNI EN ISO 15614-1:2012

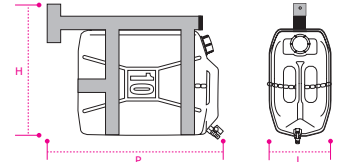

TRACTOR Plastic water tank 25 lt. with galvanized support and fixing feet

*Tanica acqua TRACTOR 25 lt.
con supporto zincato e 4 piedini*

ARTICLE	L	H	P	iL	iP	KG	N.
T973Z	225	410	490	215	275	4,85	32

TKcert RINA UNI EN ISO 15614-1:2012

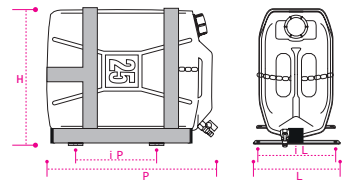

TRACTOR Plastic water tank 10 lt. with galvanized support and fixing feet

*Tanica acqua TRACTOR 10 lt.
con supporto zincato e 4 piedini*

ARTICLE	L	H	P	iL	iP	KG	N.
T974Z	200	300	350	175	200	3,10	50

TKcert RINA UNI EN ISO 15614-1:2012

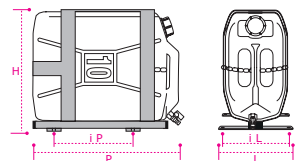

WATER TANKS



LATERAL Plastic water tank 10 lt.
with galvanized support and lateral fixing
Tanica acqua LATERAL 10 lt.
con supporto zincato e attacco laterale

ARTICLE	L	H	P	iH	iP	KG	<u>N.</u>
T979Z	190	285	350	235	200	3,90	50

TKcertRINA UNI EN ISO 15614-1:2012

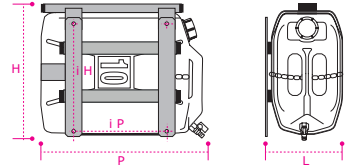

ORIGINAL Plastic water tank 10 lt.
with galvanized support for Iveco S-Way
Tanica acqua ORIGINAL 10 lt.
con supporto zincato per Iveco S-Way

ARTICLE	L	H	P	KG	<u>N.</u>
T986Z	165	315	350	3,10	40

TKcertRINA UNI EN ISO 15614-1:2012

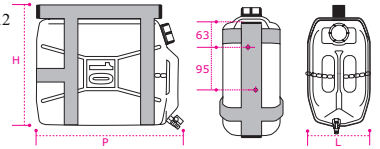

VERTICAL Plastic water tank 10 lt.
with vertical galvanized support
Tanica acqua VERTICAL 10 lt.
con supporto zincato verticale

ARTICLE	L	H	P	KG	<u>N.</u>
T967Z	175	355	290	2,60	50

TKcertRINA UNI EN ISO 15614-1:2012

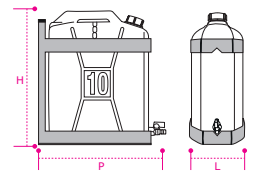

VERTICAL Plastic water tank 25 lt.
with vertical galvanized support
Tanica acqua VERTICAL 25 lt.
con supporto zincato verticale

ARTICLE	L	H	P	KG	<u>N.</u>
T964Z	225	490	420	4,30	32

TKcertRINA UNI EN ISO 15614-1:2012

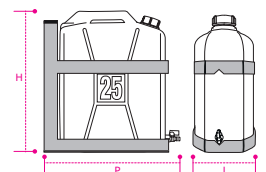

WATER TANKS



VERTICAL Plastic water tank 25 lt. with vertical galvanized support

Tanica acqua VERTICAL 25 lt. con supporto zincato verticale

ARTICLE	L	H	P	KG	<u>N.</u>
T965Z	225	490	580	5,60	24

TKcert RINA UNI EN ISO 15614-1:2012

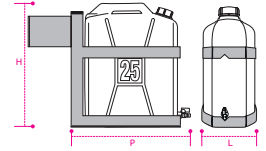

Plastic water tank 10 lt. with galvanized support for Piaggio PORTER NP6

Tanica acqua 10 lt. con supporto zincato per Piaggio PORTER NP6

ARTICLE	L	H	P	KG	<u>N.</u>
T988Z	190	320	380	3,70	24

TKcert RINA UNI EN ISO 15614-1:2012

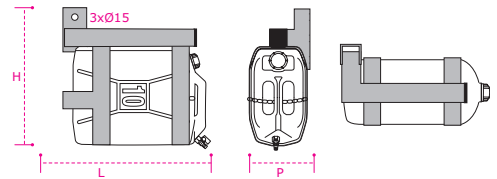

CURVED Plastic water tank 10 lt. with orizontal galvanized curved left support

Tanica acqua CURVED 10 lt. con supporto orizzontale curvato sinistro lato guida

ARTICLE	L	H	P	P1	KG	<u>N.</u>
T985Z	560	360	310	180	4,20	24

TKcert RINA UNI EN ISO 15614-1:2012

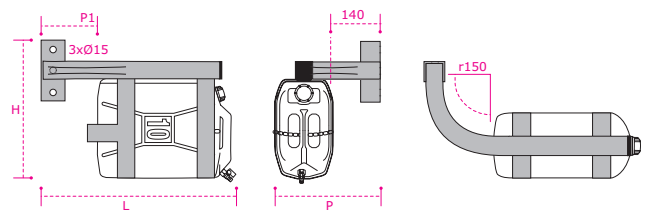

CURVED Plastic water tank 25 lt. with vertical galvanized curved support

Tanica acqua CURVED 25 Lt. con supporto curvato zincato verticale

ARTICLE	L	H	P	P1	KG	<u>N.</u>
T982Z	225	580	600	210	5,70	24

TKcert RINA UNI EN ISO 15614-1:2012

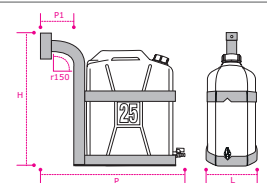



Plastic water tank 10 lt. with faucet

Tanica nuda 10 lt. con rubinetto

ARTICLE	L	H	P	KG	N.
T969	156	245	370	0,57	60

TKcert RINA UNI EN ISO 15614-1:2012

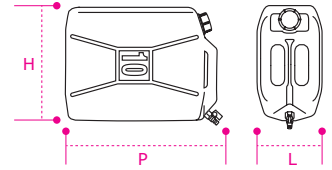

Plastic water tank 15 lt. with faucet

Tanica nuda 15 lt. con rubinetto

ARTICLE	L	H	P	KG	N.
T984	176	286	421	1,43	60

TKcert RINA UNI EN ISO 15614-1:2012

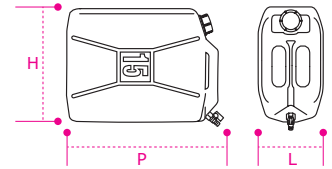

Plastic water tank 20 lt. with faucet

Tanica nuda 20 lt. con rubinetto

ARTICLE	L	H	P	KG	N.
T972	190	315	440	0,89	60

TKcert RINA UNI EN ISO 15614-1:2012

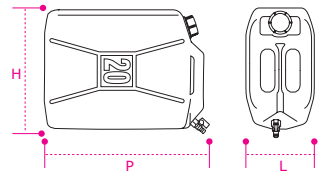

Plastic water tank 25 lt. with faucet

Tanica nuda 25 lt. con rubinetto

ARTICLE	L	H	P	KG	N.
T961	215	340	480	1,20	60

TKcert RINA UNI EN ISO 15614-1:2012

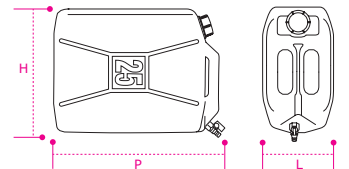

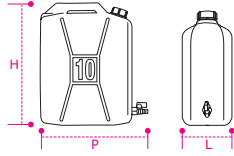

Vertical plastic water tank 10 lt. with faucet

Tanica verticale 10 lt. nuda con rubinetto

ARTICLE	L	H	P	KG	N.
T970	156	360	285	0,57	60

TKcertRINA UNI EN ISO 15614-1:2012

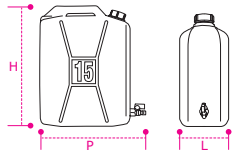

Vertical plastic water tank 15 lt. with faucet

Tanica verticale 15 lt. nuda con rubinetto

ARTICLE	L	H	P	KG	N.
T983	176	416	331	1,43	60

TKcertRINA UNI EN ISO 15614-1:2012

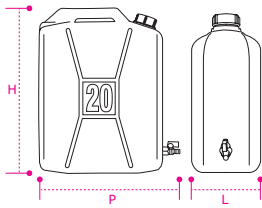

Vertical plastic water tank 20 lt. with faucet

Tanica verticale 20 lt. nuda con rubinetto

ARTICLE	L	H	P	KG	N.
T971	190	440	360	0,89	60

TKcertRINA UNI EN ISO 15614-1:2012

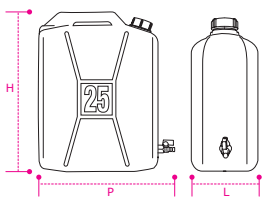

Vertical plastic water tank 25 lt. with faucet

Tanica verticale 25 lt. nuda con rubinetto

ARTICLE	L	H	P	KG	N.
T963	215	480	380	1,10	60

TKcertRINA UNI EN ISO 15614-1:2012

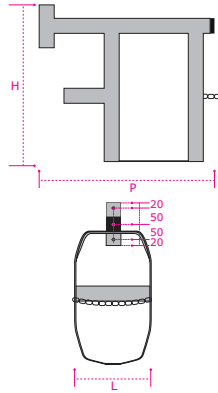

Galvanized support for water tank 25 lt. *Supporto zincato per tanica acqua 25 lt.*

ARTICLE	L	H	P	KG	
T960	225	410	500	4,10	1

TKcertRINA UNI EN ISO 15614-1:2012

i Complete of pvc cap, chain and padlock.
Completo di tappo in pvc, catena e lucchetto.

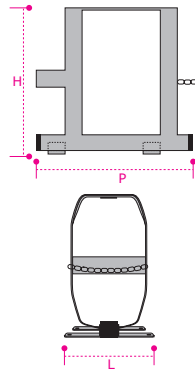

Galvanized support for water tank 25 lt. with fixing feet *Supporto zincato per tanica acqua 25 lt. con 4 piedini*

ARTICLE	L	H	P	iL	iP	KG	
T975	225	410	395	215	275	3,85	1

TKcertRINA UNI EN ISO 15614-1:2012

i Complete of pvc cap, chain and padlock.
Completo di tappo in pvc, catena e lucchetto.

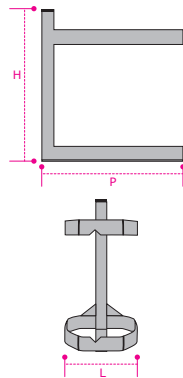

Vertical galvanized support or water tank 25 lt. *Supporto zincato verticale per tanica acqua 25 lt.*

ARTICLE	L	H	P	KG	
T978	225	440	400	3,55	1

TKcertRINA UNI EN ISO 15614-1:2012

i Complete of pvc cap, chain and padlock.
Completo di tappo in pvc, catena e lucchetto.

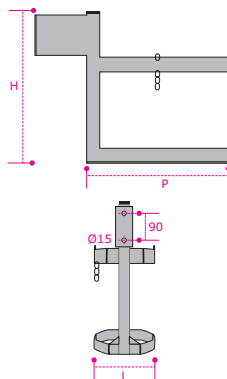

Vertical galvanized support for water tank with bracket 25 lt. *Supporto zincato verticale per tanica acqua 25 lt. con staffa di fissaggio*

ARTICLE	L	H	P	KG	
T981	225	470	555	4,65	1

TKcertRINA UNI EN ISO 15614-1:2012

i Complete of pvc cap, chain and padlock.
Completo di tappo in pvc, catena e lucchetto.

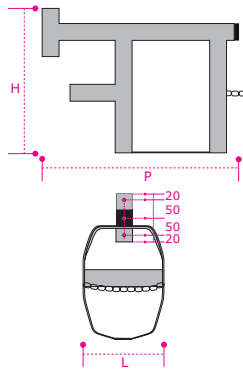

Galvanized support for water tank 10 lt.

Supporto zincato per tanica acqua 10 lt.

ARTICLE	L	H	P	KG	
T964	175	315	440	3,25	1

TKcertRINA UNI EN ISO 15614-1:2012

i Complete of pvc cap, chain and padlock.
Completo di tappo in pvc, catena e lucchetto.

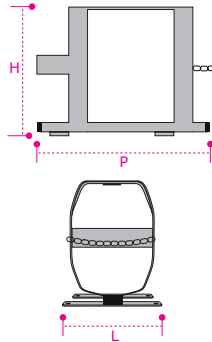

Galvanized support for water tank 10 lt. with fixing feet

Supporto zincato per tanica acqua 10 lt. con 4 piedini

ARTICLE	L	H	P	iL	iP	KG	
T974	200	295	295	175	200	2,60	1

TKcertRINA UNI EN ISO 15614-1:2012

i Complete of pvc cap, chain and padlock.
Completo di tappo in pvc, catena e lucchetto.

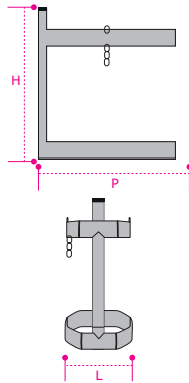

Vertical galvanized support for water tank 10 lt.

Supporto zincato verticale per tanica acqua 10 lt.

ARTICLE	L	H	P	KG	
T976	175	300	290	2,10	1

TKcertRINA UNI EN ISO 15614-1:2012

i Complete of pvc cap, chain and padlock.
Completo di tappo in pvc, catena e lucchetto.

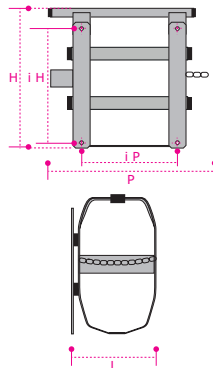

Vertical galvanized support for water tank 10 lt. with lateral fixing

Supporto zincato per tanica acqua 10 lt. con attacco laterale

ARTICLE	L	H	P	iH	iP	KG	
T977	190	285	290	235	200	3,40	1

TKcertRINA UNI EN ISO 15614-1:2012

i Complete of pvc cap, chain and padlock.
Completo di tappo in pvc, catena e lucchetto.

Threaded support for soap dispenser horizontal bracket

Supporto filettato per portasapone staffa orizzontale



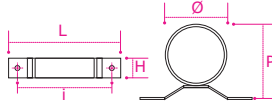

ARTICLE	L	H	P	D	i	KG	
T999	114	20	80	60	96	0,12	1

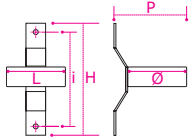
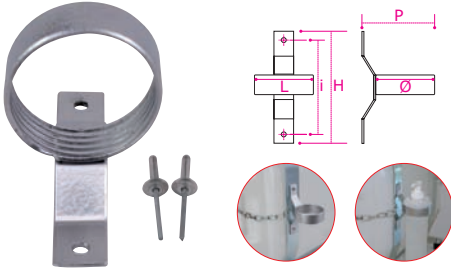

Threaded support for soap dispenser vertical bracket

Supporto filettato per portasapone staffa verticale



ARTICLE	L	H	P	D	i	KG	
T998	60	114	80	60	96	0,12	1

Shock absorbers kit

Kit ammortizzatori con viti tge 8x16



ARTICLE	H	D	KG	
R70126	25	30	0,25	1

Rubber pipe with wrappers

Tubo cristallo e fascetta bifilare per rubinetto 1/4 Ø11



ARTICLE	L	D	KG	
R70127	600	14	0,06	1

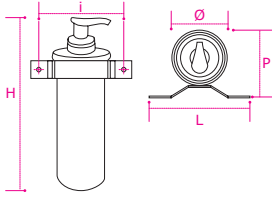

Soap dispenser kit horizontal bracket
Kit portasapone staffa orizzontale

ARTICLE	L	H	P	D	i	KG	
T999K	114	200	80	60	96	0,16	1

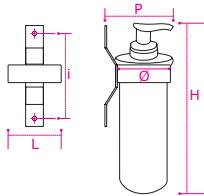

Soap dispenser kit vertical bracket
Kit portasapone staffa verticale

ARTICLE	L	H	P	D	i	KG	
T998K	65	200	80	60	96	0,16	1

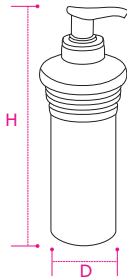

Universal tpl soap dispenser
Portasapone universale in tpl

ARTICLE	H	D	KG	
V10026	200	60	0,07	1



Anti-theft cap for water tank with double keys
Tappo anti furto per tani caac quac ondoppi ac hiave

ARTICLE	H	D	KG	
111P	36	74	0,124	1

TKcert RINA UNI EN ISO 15614-1:2012

i Assembly sheet supplied inside the box.
Lo schema di montaggio è fornito all'interno della scatola.

PVC Cap *Tappo PVC*



ARTICLE	H	D	KG	
111	30	60	0,017	1

PVC Cap *Tappo PVC*

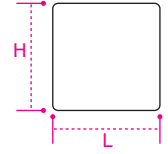

ARTICLE	L	H	KG	
110318202N	40	40	0,01	1
110318302N	50	50	0,08	1
ILR50X25	50	25	0,01	1
ILR30X15	30	15	0,01	1

Padlock
Lucchetto



ARTICLE	L	H	KG	
R60102	25	15	0,02	1

PVC Cap
Tappo tanica 30 lt.



ARTICLE	D	KG	
V20014	60	0,03	1

Inspection Cap
Tappo ispezione



ARTICLE	D	KG	
V20015	140	0,08	1

PVC Faucet
Rubinetto PVC recupero liquami



ARTICLE	L	H	KG	
V20016	70	105	0,07	1

Faucet 1/4
Rubinetto dritto passo 1/4



ARTICLE	PA	L	D	KG	
V20018	1/4	45	11	0,83	1

PVC faucet for water tank 30 lt.
Rubinetto tanica 30 lt.

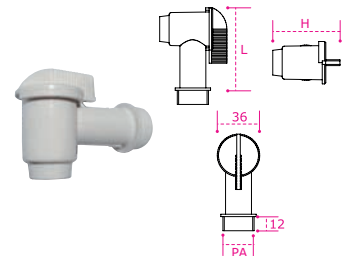

ARTICLE	L	H	PA	KG	
V20013	70	57	3/4	0,02	1

STAINLESS STEEL WATER TANK



Stainless steel ba mirror water tank 12 lt.

Tanica acciaio inox 304 ba specchiato 12 lt.

ARTICLE	L	H	P	KG	
---------	---	---	---	----	------------------------------------------------------------------------------------

V10078	130	145	400	4,15	1
--------	-----	-----	-----	------	---

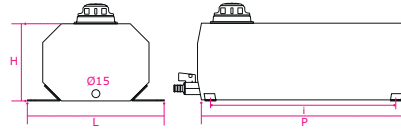

Flowered stainless steel water tank 12 lt.

Tanica acciaio inox fiore 12 lt. fissaggio con piedini

ARTICLE	L	H	P	i	KG	
---------	---	---	---	---	----	-------------------------------------------------------------------------------------

V10037	175	180	410	310	3,30	1
--------	-----	-----	-----	-----	------	---

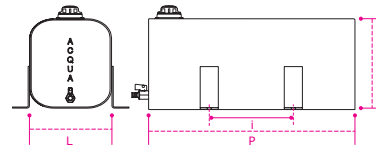

i Soap dispenser supplied separately.
Portasapone fornito separatamente.



Flowered stainless steel water tank 12 lt.

Tanica acciaio inox fiore 12 lt.

ARTICLE	L	H	P	KG	
---------	---	---	---	----	------------------------------------------------------------------------------------

V10020	175	180	450	3,30	1
--------	-----	-----	-----	------	---

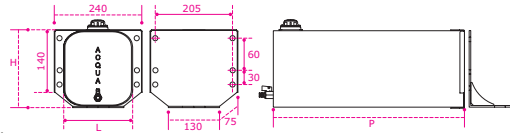

i Soap dispenser and support bracket are supplied separately.
Portasapone e staffa supporto posteriore vengono vendute separatamente.



Flowered stainless steel water tank 25 lt.

Tanica acciaio inox fiore 25 lt. con attacchi laterali ad ala di gabbiano

ARTICLE	L	H	P	KG	
---------	---	---	---	----	--------------------------------------------------------------------------------------

V10022	285	295	420	4,00	1
--------	-----	-----	-----	------	---

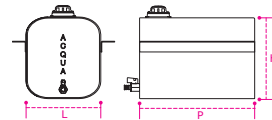

i Soap dispenser supplied separately.
Portasapone fornito separatamente.



Flowered stainless steel water tank 25 lt.

Tanica acciaio inox fiore 25 lt. fissaggio con piedini

ARTICLE	L	H	P	i	KG	
---------	---	---	---	---	----	---------------------------------------------------------------------------------------

V10039	175	400	410	310	5,70	1
--------	-----	-----	-----	-----	------	---

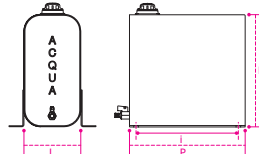

i Soap dispenser supplied separately.
Portasapone fornito separatamente.

TUBULAR WATER TANKS

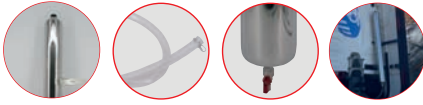
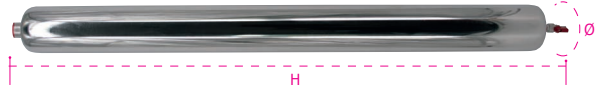

Stainless steel ba tubular water tank 12 lt. for Scania new generation

Tanica acqua a tubo inox ba 12 lt. per Scania new generation

ARTICLE	H	D	i	KG	
V10070	1280	110	430	5,50	1

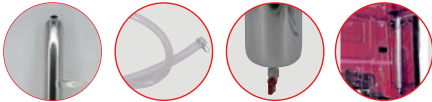
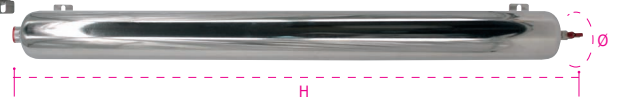

Stainless steel ba tubular water tank 12 lt. for Scania R2/R3

Tanica acqua a tubo inox ba 18 lt. per Scania R2/R3

ARTICLE	H	D	i	KG	
V10071	1280	110	135	5,35	1

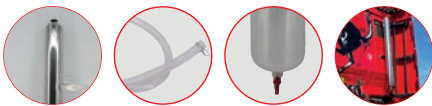
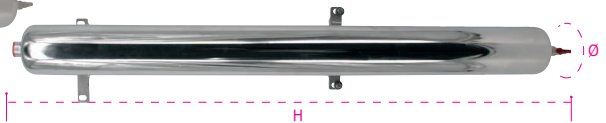

Stainless steel ba tubular water tank 12 lt. for Iveco hi-way

Tanica acqua a tubo inox ba 12 lt. per Iveco Hi-Way

ARTICLE	H	D	i	KG	
V10077	1280	110	640	6,70	1

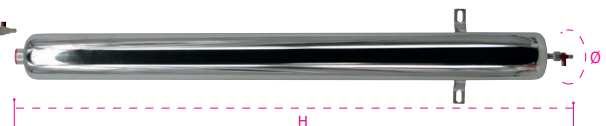

Stainless steel ba tubular water tank 12 lt. for iveco S-Way

Tanica acqua a tubo inox ba 12 lt. per iveco S-Way

ARTICLE	H	D	i	KG	
V10079	1280	110	730	6,70	1

TUBULAR WATER TANKS

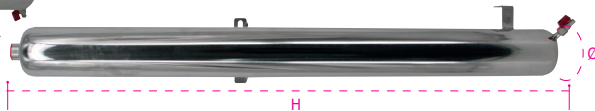

Stainless steel ba tubular water tank 12 lt. for Volvo FH4

Tanica acqua a tubo inox ba 12 lt. per Volvo FH4

ARTICLE H D i KG 

V10072 1280 110 645 5,55 1

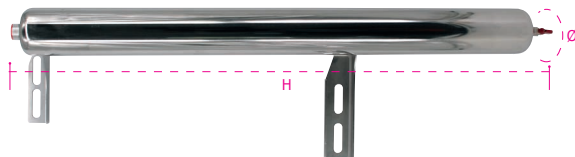
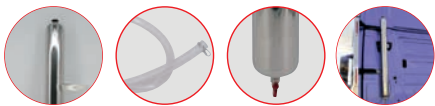

Stainless steel ba tubular water tank 12 lt. for Mercedes MP4

Tanica acqua a tubo inox ba 12 lt. per Mercedes MP4

ARTICLE H D i KG 

V10074 1280 110 785 6,75 1

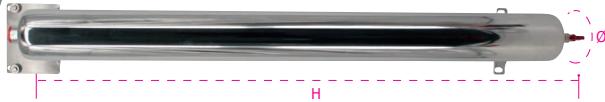
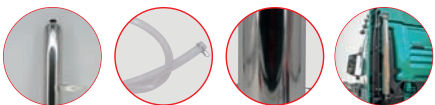

Stainless steel ba tubular water tank 12 lt. For Man E6 - TGX

Tanica acqua a tubo inox ba 12 lt. per Man E6 - TGX

ARTICLE H D i KG 

V10075 1280 110 1250 6,50 1

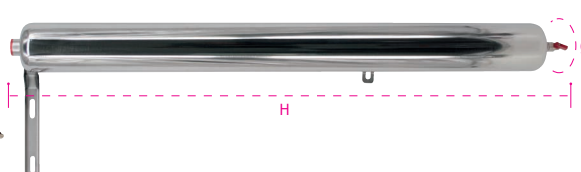

Stainless steel ba tubular water tank 12 lt. for Man TGX 2021>

Tanica acqua a tubo inox ba 12 lt. per Man TGX 2021>

ARTICLE H D i KG 

V10080 1280 110 1250 6,50 1

TUBULAR WATER TANKS

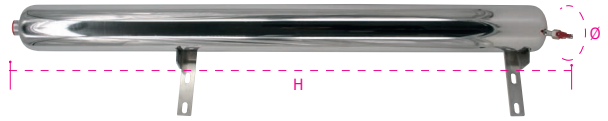
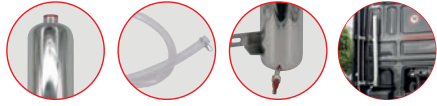

Stainless steel ba tubular water tank 12 lt. for Daf XF 106

Tanica acqua a tubo inox ba 12 lt. per Daf XF 106

ARTICLE	H	D	i	KG	
V10073	1280	110	785	5,50	1

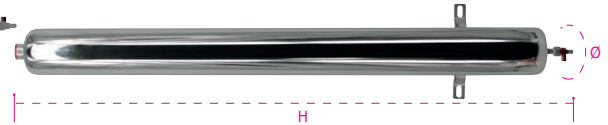

Stainless steel ba tubular water tank 12 lt. for Daf xf - xg - xg+

Tanica acqua a tubo inox ba 12 lt. per Daf XF - XG - XG+

ARTICLE	H	D	i	KG	
V10081	1280	110	1250	6,50	1

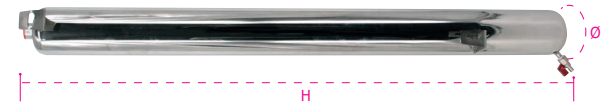
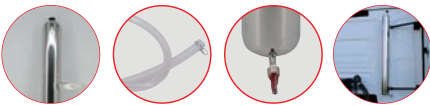

Stainless steel ba tubular water tank 12 lt. for Renault T

Tanica acqua a tubo inox ba 12 lt. per Renault T

ARTICLE	H	D	i	KG	
V10076	1280	110	965	5,55	1

Flowered stainless steel recovery tank for sewage 10 lt. with inox inspection

Tanica acciaio inox fiorettato recupero liquami 10 lt. con ispezione inox

ARTICLE	L	H	P	SP	KG	
070002/I	200	200	250	15/10	5,10	1

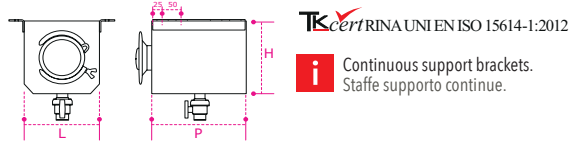

Flowered stainless steel recovery tank for sewage 18 lt. with inox inspection

Tanica acciaio inox fiorettato recupero liquami 18 lt. con ispezione inox

ARTICLE	L	H	P	SP	KG	
070001/I	300	250	250	15/10	6,85	1

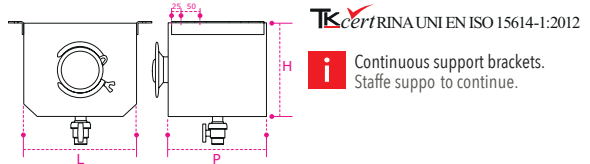

Flowered stainless steel recovery tank for sewage 36 lt. with inox inspection

Tanica acciaio inox fiorettato recupero liquami 36 lt. con ispezione inox

ARTICLE	L	H	P	SP	KG	
070010/I	400	300	300	15/10	9,60	1

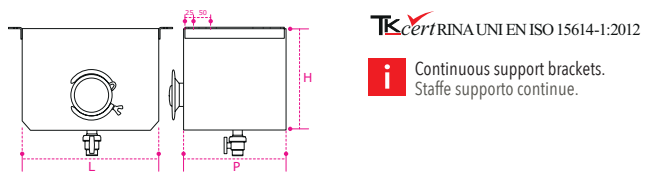
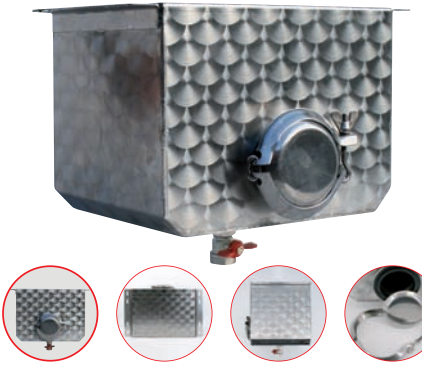

Flowered stainless steel recovery tank for sewage 60 lt. with inox inspection

Tanica acciaio inox fiorettato recupero liquami 60 lt. con i spezione i inox

ARTICLE	L	H	P	SP	KG	
070011/I	600	250	400	15/10	13,50	1

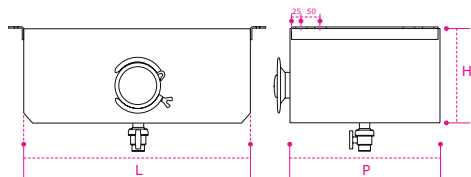

i Continuous support brackets. Ideal for Semi-trailers Lamberet Model.
Staffe suppo to continue. Ideale per Semirimorchi Mod. Lamberet.

DOCUMENT HOLDER

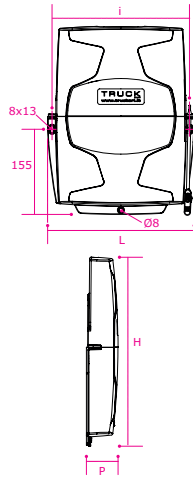

PPE extractable document holder made by injection

Portadocumenti ppe ad iniezione A4 sfilabile

ARTICLE	L	H	P	i	KG	
C30010	285	370	55	265	0,70	6



P Printable space for customization Spazio serigrafabile

ARTICLE

C30010P 130x35

H6000 Cliché for print Cliché per stampa

i Possibility to customise. Padlock on request.
Possibilità di personalizzazione, lucchetto solo su richiesta.

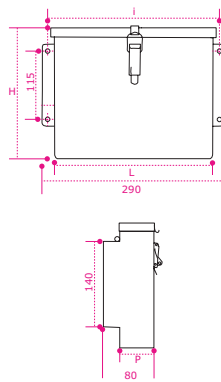

Stainless steel document holder

Portadocumenti inox lucido

ARTICLE	L	H	P	i	SP	KG	
C30002	245	210	50	275	8/10	0,70	1

P Printable space for customization Spazio serigrafabile

ARTICLE

C30002P H6000 Cliché for print Cliché per stampa

TKcert RINA UNI EN ISO 15614-1:2012

i Possibility to customise with electrochemical marking.
Possibilità di personalizzazione con marcatura elettrochimica.

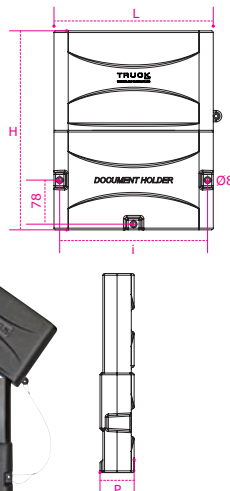

Pvc A4 document holder

Portadocumenti PVC A4

ARTICLE	L	H	P	i	KG	
C30001/2	280	350	60	260	0,70	50



P Printable space for customization Spazio serigrafabile

ARTICLE

C3001/2P 113x29

H6000 Cliché for print Cliché per stampa

i Polypropylene A4 document holder, closure without key, 3 holes Ø8 for application. Possibility to customise.
Portadocumenti in Polipropilene, formato A4, serraggio senza chiave, 3 fori di diametro 8 per applicazione. Possibilità di personalizzazione.





PALLET BOX

Closed galvanized steel pallet box

Porta pallets chiuso acciaio zincato

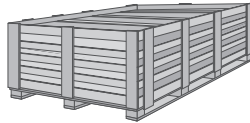

ARTICLE	L	H	P	SP	N° PALLET
C20080C	2740	650	2480	15/10	36
C20082C	2740	610	2480	15/10	30
C20084C	2740	500	2480	15/10	24
C20085C	3275	610	2480	15/10	36
C20092C	3500	500	2480	15/10	32

i Galvanized steel pallet box, 2480mm in depth it's particularly recommended for semi-trailers, supplied disassembled and boxed. Special sizes on request. For 'CLOSED' model it's possible to request a mounted product, price for assembly and transport on request.
 Porta pallet in acciaio zincato profondità 2480 particolarmente indicato per semirimorchi fornito smontato e scatola. Su richiesta misure speciali. Per il modello "CHIUISO" è possibile richiedere il prodotto montato, prezzo montaggio e trasporto da preventivare.

Closed galvanized steel pallet box

Porta pallets aperto acciaio zincato

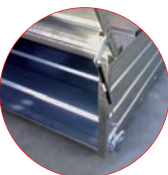
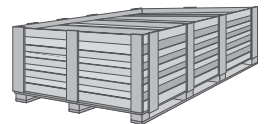

ARTICLE	L	H	P	SP	N° PALLET
C20080	2740	650	2480	15/10	36
C20082	2740	610	2480	15/10	30
C20084	2740	500	2480	15/10	24
C20085	3275	610	2480	15/10	36
C20092	3500	500	2480	15/10	32

BRACKETS FOR TOOL BOXES AND WATER TANK

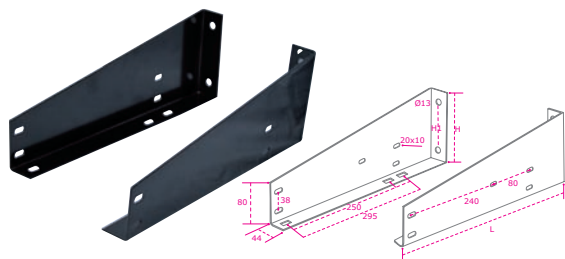

Pair of black painted universal brackets

Coppia staffe universali verniciate nero

ARTICLE	L	H	H1	SP	KG	
S60000	455	155	105	30/10	3,60	2



TKcertRINA UNI EN ISO 15614-1:2012

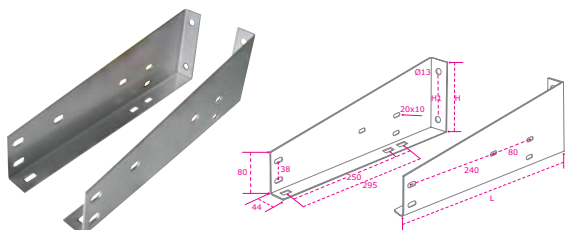

Pair of stainless steel universal brackets

Coppia staffe universali inox

ARTICLE	L	H	H1	SP	KG	
S62000	455	155	105	30/10	3,60	2



TKcertRINA UNI EN ISO 15614-1:2012

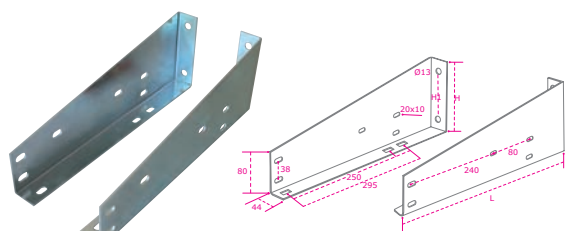

Pair of galvanized universal brackets

Coppia staffe universali zincate

ARTICLE	L	H	H1	SP	KG	
S64000	455	155	105	30/10	3,60	2



TKcertRINA UNI EN ISO 15614-1:2012

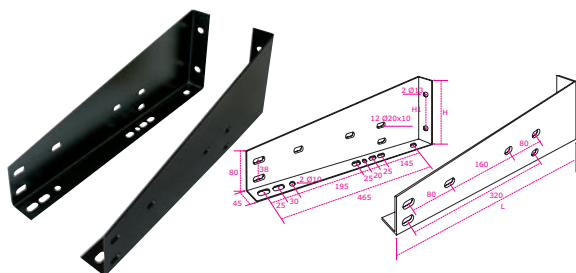

Pair of black painted universal brackets

Coppia staffe universali verniciate nero

ARTICLE	L	H	H1	SP	KG	
S61000	530	200	105	30/10	3,90	2



TKcertRINA UNI EN ISO 15614-1:2012

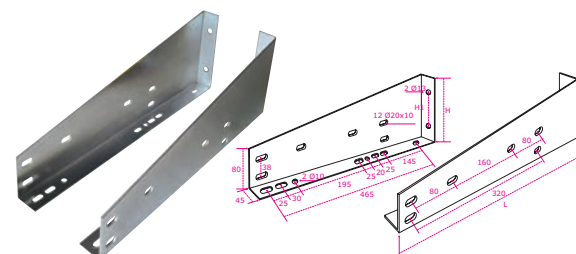

Pair of stainless steel universal brackets

Coppia staffe universali inox

ARTICLE	L	H	H1	SP	KG	
S63000	530	200	105	30/10	3,90	2



TKcertRINA UNI EN ISO 15614-1:2012

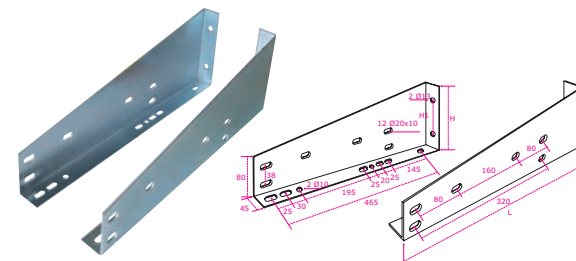

Pair of galvanized universal brackets

Coppia staffe universali zincate

ARTICLE	L	H	H1	SP	KG	
S65000	530	200	105	30/10	3,90	2



TKcertRINA UNI EN ISO 15614-1:2012

BRACKETS FOR TOOL BOXES AND WATER TANK

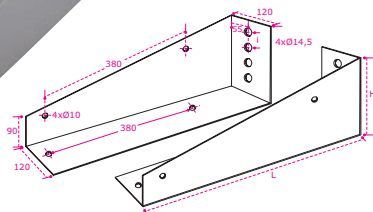
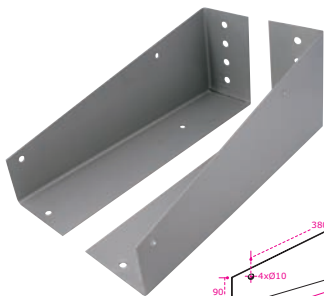

Pair of stainless steel brackets

Coppia staffe acciaio inox AISI 304

ARTICLE	L	H	i	SP	KG	
C70615	600	230	5	25/10	7,70	2

 RINA UNI EN ISO 15614-1:2012



Recommended for Tractor Scania New Generation.
Consigliate per Trattore Scania New Generation.

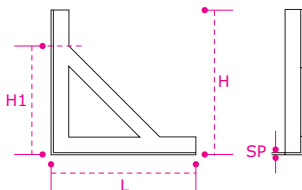

Pair of galvanized brackets

Coppia staffe lamiera zincata

ARTICLE	L	H	H1	SP	KG	
C70630	270	270	160	35/10	2,45	2
C70620	350	350	280	35/10	3,18	2
C70621	500	500	380	35/10	4,48	2
C70622	600	600	460	35/10	5,68	2
C70623	700	700	530	35/10	6,40	2

 RINA UNI EN ISO 15614-1:2012

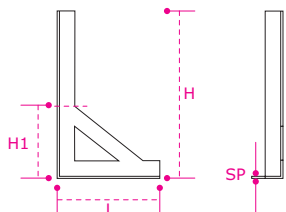

Pair of galvanized brackets

Coppia staffe lamiera zincata

ARTICLE	L	H	H1	SP	KG	
C70631	340	200	160	35/10	2,45	2

 RINA UNI EN ISO 15614-1:2012

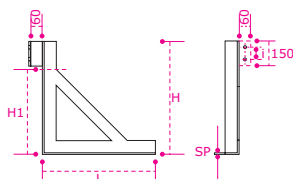
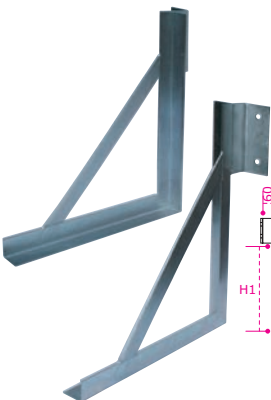

Pair of galvanized brackets with support

Coppia staffe zincate con supporto

ARTICLE	L	H	H1	SP	i	KG	
C70626	500	500	380	35/10	100	2,70	2
C70624	600	600	460	35/10	100	3,17	2

 RINA UNI EN ISO 15614-1:2012

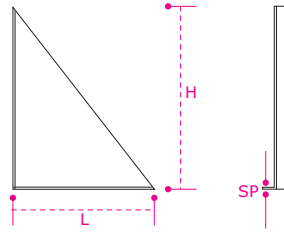
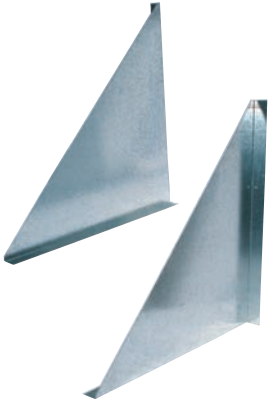

Pair of galvanized brackets

Coppia staffe lamiera zincata

ARTICLE	L	H	SP	KG	
C70601	450	350	20/10	2,90	2
C70602	500	400	20/10	3,60	2
C70604	600	600	20/10	5,60	2

TK cert RINA UNI EN ISO 15614-1:2012

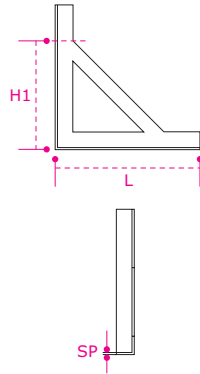

Pair of fowered stainless steel brackets

Coppia staffe inox fiore

ARTICLE	L	H	H1	SP	KG	
IF70620	350	350	280	30/10	3,18	2
IF70621	500	500	380	30/10	4,48	2
IF70622	600	600	460	30/10	5,68	2
IF70623	700	700	530	30/10	6,40	2

TK cert RINA UNI EN ISO 15614-1:2012

BUMPER BAR

Bumper bar for Daily >2000

Barra paraincastri Daily >2000

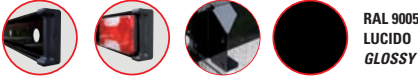

i Attention: it is supplied with lateral welded caps.
Attenzione: fornita con tamponi laterali saldati.

ARTICLE	L	H	P	SP	KG	<u>N.</u>
R10101	1900	175	70	15/10	8,20	1

Universal bumper bar for Daily

Barra paraincastri universale per Daily



i Attention: it is supplied with lateral welded caps.
Attenzione: fornita con tamponi laterali saldati.

ARTICLE	L	H	P	SP	KG	<u>N.</u>
R10104	1900	230	100	15/10	10,70	1

Bumper bar for Nissan Cabstar

Barra paraincastri Nissan Cabstar

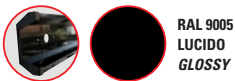

i Attention: it is supplied with lateral welded caps.
Attenzione: fornita con tamponi laterali saldati.

ARTICLE	L	H	P	SP	KG	<u>N.</u>
R20102	1730	216	95	20/10	11,20	1

Bumper bar for Ford Transit

Barra paraincastri per Ford Transit



i Attention: it is supplied with lateral welded caps.
Attenzione: fornita con tamponi laterali saldati.

ARTICLE	L	H	P	SP	KG	<u>N.</u>
R10105	1860	220	90	15/10	8,55	1

BUMPER BAR

Lamp holder bar for Piaggio PORTER NP6

Barra portafanali per Piaggio PORTER NP6



RAL 9005
LUCIDO
GLOSSY

ARTICLE	L	H	P	SP	KG	N.
R10106	1600	200	80	15/10	7,60	1

i Attention: to be installed only in presence of approved bumper bar. Attenzione: da installare solo in presenza di barra paraincrastrati omologata.

White painted lamp holder bar for Master

Barra portafanali verniciata bianca per Master



RAL 9016
LUCIDO
GLOSSY

ARTICLE	L	H	P	SP	KG	N.
R10114	1920	280	90	15/10	18,60	1

i Attention: to be installed only in presence of approved bumper bar. Attenzione: da installare solo in presenza di barra paraincrastrati omologata.

White painted lamp holder bar for Ducato

Barra porta fanali verniciata bianca per Ducato



RAL 9016
LUCIDO
GLOSSY

ARTICLE	L	H	SP	KG	N.
R10115	1900	230	15/10	18,60	1

i Attention: to be installed only in presence of approved bumper bar. Attenzione: da installare solo in presenza di barra paraincrastrati omologata.

Grey painted lamp holder bar Barra portafanali grigia



RAL 7015
LUCIDO
GLOSSY



ARTICLE	L	H	P	SP	KG	N.
P150	1500	230	100	15/10	7,50	1
P160	1600	230	100	15/10	7,90	1
P170	1700	230	100	15/10	8,30	1
P180	1800	230	100	15/10	8,60	1
P190	1900	230	100	15/10	8,80	1

ARTICLE	L	H	P	SP	KG	N.
P200	2000	230	100	15/10	9,30	1
P210	2100	230	100	15/10	10,00	1
P220	2200	230	100	15/10	10,50	1
P230	2300	230	100	15/10	11,00	1
P240	2400	230	100	15/10	11,20	1

i Attention: to be installed only in presence of approved bumper bar. Attenzione: da installare solo in presenza di barra paraincrastrati omologata.

BUMPER BAR

White painted lamp holder bar *Barraportaf analibi anca*



RAL 9016
LUCIDO
GLOSSY

ARTICLE	L	H	P	SP	KG	$\frac{N.}{\text{---}}$
PB230	2300	230	100	15/10	11,00	1
PB240	2400	230	100	15/10	11,20	1

i Attention: to be installed only in presence of approved bumper bar. Attenzione: da installare solo in presenza di barra paraincastri omologata.

Aluminum lamp holder bar *Barraportaf analial luminio*



i Attention: to be installed only in presence of approved bumper bar. Attenzione: da installare solo in presenza di barra paraincastri omologata.

ARTICLE	L	H	P	SP	KG	$\frac{N.}{\text{---}}$
P240A20	2400	230	100	20/10	3,13	1

Flowered stainless steel lamp holder bar *Portafanali inox fiore*

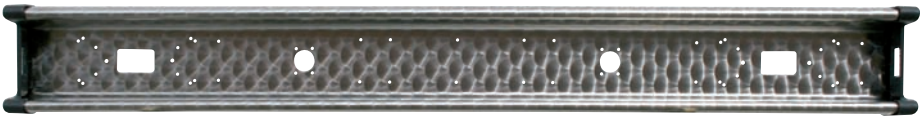

ARTICLE	L	H	P	SP	KG	$\frac{N.}{\text{---}}$
R61119	1900	230	100	15/10	8,90	1
R61120	2000	230	100	15/10	9,40	1
R61121	2100	230	100	15/10	10,00	1

ARTICLE	L	H	P	SP	KG	$\frac{N.}{\text{---}}$
R61122	2200	230	100	15/10	10,60	1
R61105	2300	230	100	15/10	11,30	1
R611051	2400	230	100	15/10	11,60	1

i Attention: to be installed only in presence of approved bumper bar. Attenzione: da installare solo in presenza di barra paraincastri omologata.

Flowered stainless steel lamp holder bar *Portafanali inox fiore*



ARTICLE	L	H	SP	KG	$\frac{N.}{\text{---}}$
R61219	1900	270	15/10	8,90	1
R61220	2000	270	15/10	9,40	1
R61221	2100	270	15/10	10,00	1

ARTICLE	L	H	SP	KG	$\frac{N.}{\text{---}}$
R61222	2200	270	15/10	10,60	1
R61205	2300	270	15/10	11,30	1
R612051	2400	270	15/10	11,60	1

i Attention: to be installed only in presence of approved bumper bar. Attenzione: da installare solo in presenza di barra paraincastri omologata.

BUMPER BAR

Grey painted lamp holder bar with riser *Portafanali con alzata verniciata grigia*



RAL 7015
LUCIDO
GLOSSY

i Attention: to be installed only in presence of approved bumper bar.
Attenzione: da installare solo in presenza di barra paraincrastrati omologata.

ARTICLE	L	H	SP	KG	N. Pezzi
R61208	2300	480	15/10	16,90	1
R612081	2400	480	15/10	17,80	1

White painted lamp holder bar with riser *Portafanali con alzata verniciata bianca*



RAL 9016
LUCIDO
GLOSSY

i Attention: to be installed only in presence of approved bumper bar.
Attenzione: da installare solo in presenza di barra paraincrastrati omologata.

ARTICLE	L	H	SP	KG	N. Pezzi
R602081F	2300	480	15/10	17,80	1
R60208F	2400	480	15/10	16,90	1

Flowered stainless steel lamp holder bar with riser *Portafanali inox fiore con alzata*

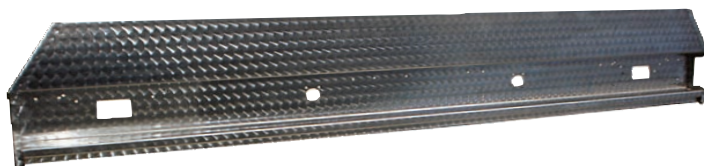

ARTICLE	L	H	SP	KG	N. Pezzi
R60208	2300	480	15/10	16,20	1
R602081	2400	480	15/10	17,80	1

i Attention: to be installed only in presence of approved bumper bar. Attenzione: da installare solo in presenza di barra paraincrastrati omologata.

Stainless steel lamp holder bar with riser *Portafanali inox liscio con alzata*



ARTICLE	L	H	SP	KG	N. Pezzi
R60208120L	2400	480	20/10	24,00	1

i Attention: to be installed only in presence of approved bumper bar. Attenzione: da installare solo in presenza di barra paraincrastrati omologata.

Almond stainless steel 3+1 lamp holder with riser

Portafanali in alluminio mandorlato 3+1 con alzata

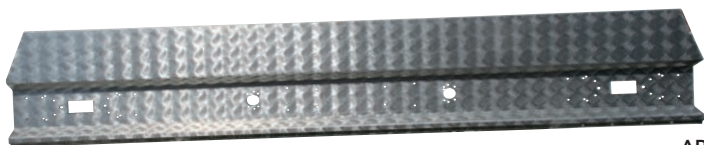



ARTICLE	L	H	SP	KG	N. Pezzi
R622081	2400	480	30/10	12,20	1

i Attention: to be installed only in presence of approved bumper bar. Attenzione: da installare solo in presenza di barra paraincrastrati omologata.

Pvc cap for bumper bar quick installation for sidemarker lamp

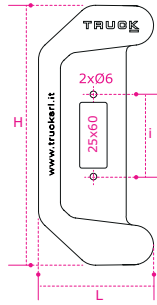
Tampone perforato inserimento rapido con predisposizione universale per sidemarker



ARTICLE	L	H	i	KG	
C408	105	237	75	0,15	50



i Possibility of easily installing all the models of sidemarker present on national and foreign markets.
Possibilità di installare facilmente tutti i modelli di sidemarker presenti sul mercato nazionale ed estero.

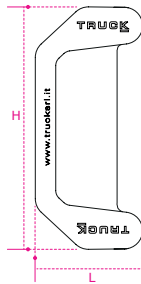

Pvc cap for bumper bar quick installation

Tampone laterale paraincassi chiuso attacco rapido

ARTICLE	L	H	KG	
C409	105	237	0,14	50

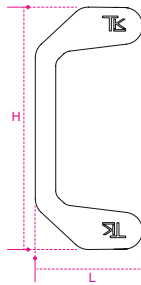

Universal PVC cap for bumper bar

Tampone laterale paraincassi universale

ARTICLE	L	H	KG	
C404	100	237	0,03	50

i Automatic insertion to clip.
Inserimento automatico a clip.

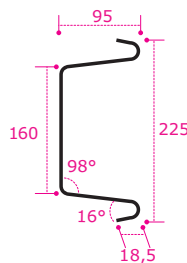

Pvc cap for bumper bar

Tampone laterale stretto per paraincassi

ARTICLE	L	H	KG	
C401	100	230	0,03	50

i Insertion with 4 black rivets RIV4814N provided.
Inserimento con 4 rivetti RIV4814N neri forniti.

ACCESSORIES FOR BUMPER BAR

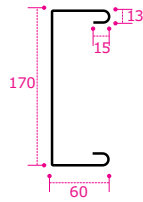

PVC Cap for Bumper Bar Daily 2000-2020

Tampone Laterale Paraincastri Daily 2000-2020

ARTICLE	L	H	KG	
C403	70	175	0,07	50

i Insertion with 4 black rivets RIV4814N provided.
Inserimento con 4 rivetti RIV4814N neri forniti.

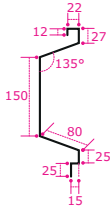

Flowered stainless steel cap for bumper bar

Tampone laterale acciaio inox fioretato per paraincastri

ARTICLE	L	H	SP	KG	
R61205CA	85	255	15/10	0,20	1

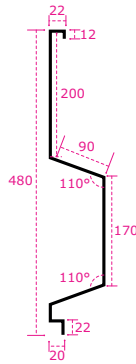

Flowered stainless steel cap for bumper bar with raiser

Tampone laterale acciaio inox fioretato per paraincastri con alzata

ARTICLE	L	H	SP	KG	
R60208CAD	90	450	15/10	0,40	1
R60208CAS	90	450	15/10	0,40	1

Stainless steel hinge with holes

Cerniera inox con fori



ARTICLE	L	H	SP	KG	
C400	2500	60	20/10	3,30	1

Black rivet Rivetto nero



ARTICLE	L	D	D1	KG	
RIV4814N	12	4,8	14	0,01	250

i For PVC cap C401-C403.
Per tampone C401-C403.

Kit 4 black rivets Set 4 rivetti neri



ARTICLE	L	D	D1	KG	
C406	12	4,8	14	0,04	1

i For PVC cap C401-C403.
Per tampone C401-C403.

Plastic cap Tappo Unipress



ARTICLE	ØHole Foro	D	KG	
A5	9,5>13,5	16	0,002	100

i Used to cover wrong holes on mudguards.
Utilizzato per coprire fori sbagliati su parafanghi.

LICENSE PLATE HOLDER



Extractable stainless steel license plate holder

Portatarga estraibile inox

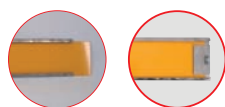

i V10045 used for european plates.
V10045 utilizzata per targhe europee.

ARTICLE	L	H	SP	KG	
V10046	500	118	8/10	0,60	50
V10045	540	118	8/10	0,60	50

License plate repeater



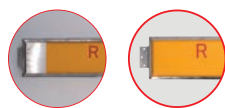

Targa ripetitrice

ARTICLE	L	H	SP	KG	
T90103	480	110	8/10	0,12	1



Adhesive alphanumeric characters

Caratteri alfanumerici adesivi

ARTICLE	All letters	ART. LETT. H 	ART. LETT. H 	ART. LETT. H 	ART. LETT. H 
T90104	Completo di tutte le lettere	C410 A 78 1	C419 J 78 1	C428 S 78 1	C437 2 78 1
	A B C D E F	C411 B 78 1	C420 K 78 1	C429 T 78 1	C438 3 78 1
	G H I J K L	C412 C 78 1	C421 L 78 1	C430 U 78 1	C439 4 78 1
	M N O P Q R	C413 D 78 1	C422 M 78 1	C431 V 78 1	C440 5 78 1
	S T U V W X	C414 E 78 1	C423 N 78 1	C432 W 78 1	C441 6 78 1
	Y Z 1 2 3 4	C415 F 78 1	C424 O 78 1	C433 X 78 1	C442 7 78 1
	5 6 7 8 9 0	C416 G 78 1	C425 P 78 1	C434 Y 78 1	C443 8 78 1
		C417 H 78 1	C426 Q 78 1	C435 Z 78 1	C444 9 78 1
		C418 I 78 1	C427 R 78 1	C436 1 78 1	C445 0 78 1

Extractable license plate holder with spring

Portatarga estraibile a molla

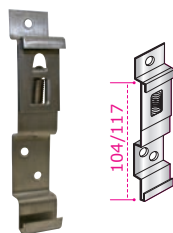



ARTICLE	L	H	SP	KG	
K1000	104	107	15/10	0,31	2

Plate fixing kit

Kit fissaggio targa



ARTICLE	KG	
E32146	0,02	10

LICENSE PLATE HOLDER

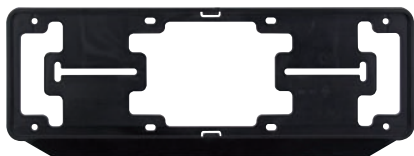

Pvc black front license plate holder

Portatarga anteriore nero

ARTICLE	DESCRIPTION	L	H	KG	
E30323	PVC PVC	375	125	0,18	100
E30323P	PVC Customized PVC Personalizzato	375	125	0,18	100
C35001	Customized cliché Cliché Personalizzato				

i Customizable area 244x13 mm (LxH). Minimum order 100 pieces.
Spazio personalizzabile 244x13 mm. (LxH). Ordine minimo 100 pezzi.



Black front license plate holder

Portatarga anteriore nero

ARTICLE	DESCRIPTION	L	H	KG	
E30339	Painted sheet Lamiera verniciata	375	125	0,15	100

i Not customizable. Minimum order 100 pieces.
Non personalizzabile. Minimo d'ordine 100 pezzi.



Aluminium front license plate holder

Portatarga anteriore alluminio

ARTICLE	DESCRIPTION	L	H	KG	
E30326	Gray anod. Alu. Alu anod. grigio	375	125	0,15	100

i Not customizable. Minimum order 100 pieces.
Non personalizzabile. Minimo d'ordine 100 pezzi.



Black rear license plate holder

Portatarga posteriore nero

ARTICLE	DESCRIPTION	L	H	KG	
E30331	PVC PVC	535	125	0,15	100
E30331P	PVC customized PVC personalizzato	535	125	0,15	100
C35001	Customized cliché Cliché personalizzato				

i Customizable area 413x13 mm (LxH). Minimum order 100 pieces.
Spazio personalizzabile 413x13 mm. (LxH). Ordine minimo 100 pezzi.



ARTICLE	DESCRIPTION	L	H	KG	
E30341	Painted sheet Lamiera verniciata	535	125	0,15	100
E30341P	Painted sheet Lamiera verniciata	535	125	0,15	100
C35001	Customized cliché Cliché personalizzato				

Aluminium rear license plate holder

Portatarga posteriore alluminio

ARTICLE	L	H	KG	
E30332	535	135	0,10	100
E30332P	535	135	0,10	100

ARTICLE	Description
C35001	Customized cliché Cliché personalizzato

i Customizable area 413x13 mm (LxH). Minimum order 100 pieces.
Spazio personalizzabile 413x13 mm. (LxH). Ordine minimo 100 pezzi.



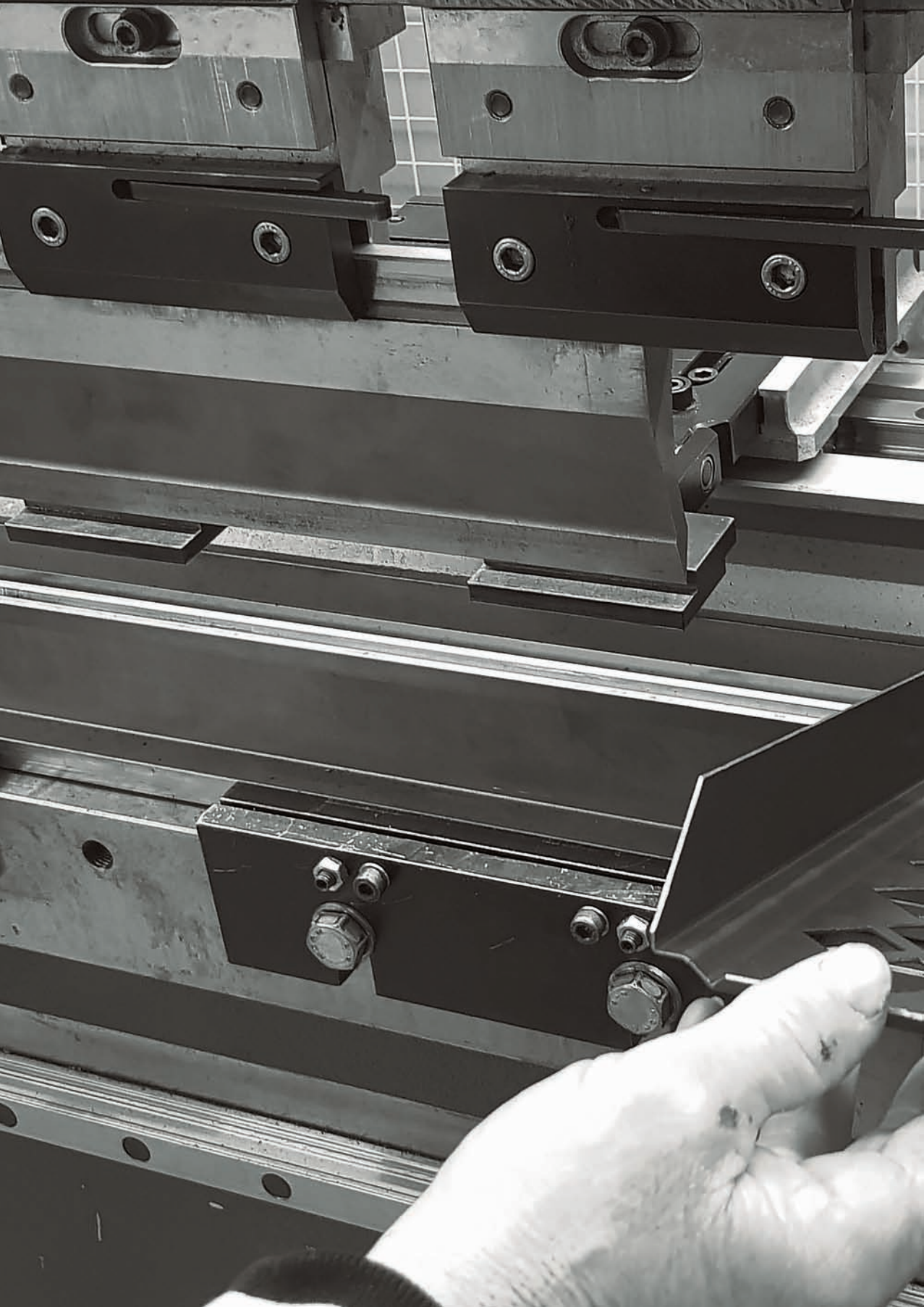



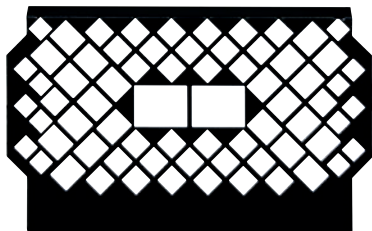

Black painted protective grill for Iveco Daily 2021

Griglia parasassi Iveco Daily 2021 verniciata nero attacco barra

ARTICLE	L	H	P	SP	KG	
V10212	360	225	22	15/10	0,65	2

i The application on the bar has been designed to speed up the operator's work, respecting the section of the bar and the functions of the rear lamp. Quick change and replacement of the rear light and bulbs.
Il concetto dell'applicazione sulla barra è stato studiato per velocizzare il lavoro dell'operatore, rispettando la sezione della barra e le funzioni del fanale. Rapido cambio e sostituzione del fanale e delle lampadine.



Black painted protective grill for Daily 2000/19

Griglia parasassi per Daily 2000/19 verniciata nero

ARTICLE	L	H	P	SP	KG	
V10301	365	200	115	15/10	1,60	2

i The application on the bar has been designed to speed up the operator's work, respecting the section of the bar and the functions of the rear lamp. Quick change and replacement of the rear light and bulbs.
Il concetto dell'applicazione sulla barra è stato studiato per velocizzare il lavoro dell'operatore, rispettando la sezione della barra e le funzioni del fanale. Rapido cambio e sostituzione del fanale e delle lampadine.

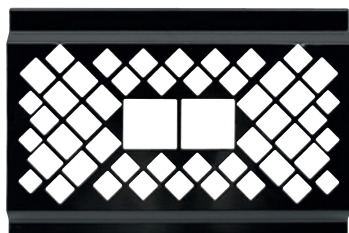

Black painted protective grill for New Daily >2020 bar attachment

Griglia parasassi New Daily >2020 attacco barra verniciata nero

ARTICLE	L	H	P	SP	KG	
V10213	340	230	45	15/10	0,90	2

i The application on the bar has been designed to speed up the operator's work, respecting the section of the bar and the functions of the rear lamp. Quick change and replacement of the rear light and bulbs.
Il concetto dell'applicazione sulla barra è stato studiato per velocizzare il lavoro dell'operatore, rispettando la sezione della barra e le funzioni del fanale. Rapido cambio e sostituzione del fanale e delle lampadine.

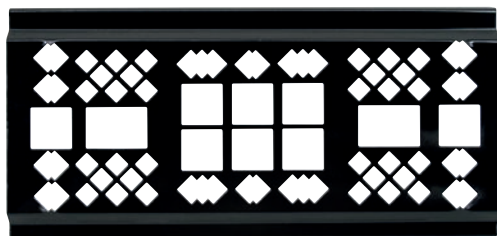

Black painted protective grill 7 functions bar attachment

Griglia parasassi 7 funzioni attacco barra verniciata nero

ARTICLE	L	H	P	SP	KG	
V10215	485	235	45	15/10	1,35	2

i The application on the bar has been designed to speed up the operator's work, respecting the section of the bar and the functions of the rear lamp. Quick change and replacement of the rear light and bulbs.
Il concetto dell'applicazione sulla barra è stato studiato per velocizzare il lavoro dell'operatore, rispettando la sezione della barra e le funzioni del fanale. Rapido cambio e sostituzione del fanale e delle lampadine.



Black painted protective grill for Ford Transit

Griglia parasassi Ford Transit verniciata nero
attacco barra

ARTICLE	L	H	P	SP	KG	
V10219	425	215	100	15/10	1,30	2

i The application on the bar has been designed to speed up the operator's work, respecting the section of the bar and the functions of the rear lamp. Quick change and replacement of the rear light and bulbs.

Il concetto dell'applicazione sulla barra è stato studiato per velocizzare il lavoro dell'operatore, rispettando la sezione della barra e le funzioni del fanale.
Rapido cambio e sostituzione del fanale e delle lampadine.

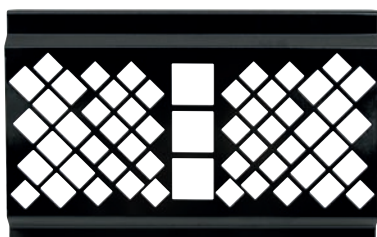

Black painted protective grill for Nissan Cabstar

Griglia parasassi Nissan Cabstar verniciata nero
attacco barra

ARTICLE	L	H	P	SP	KG	
V10214	370	230	45	15/10	1,00	2

i The application on the bar has been designed to speed up the operator's work, respecting the section of the bar and the functions of the rear lamp. Quick change and replacement of the rear light and bulbs.

Il concetto dell'applicazione sulla barra è stato studiato per velocizzare il lavoro dell'operatore, rispettando la sezione della barra e le funzioni del fanale.
Rapido cambio e sostituzione del fanale e delle lampadine.

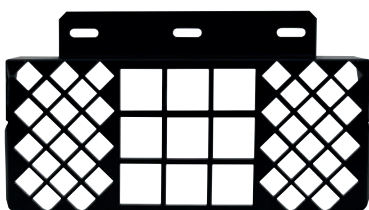

Black painted protective grill for Isuzu

Griglia parasassi Isuzu verniciata nero

ARTICLE	L	H	P	i	SP	KG	
V10238	360	205	65	110	25/10	1,20	2

i The application on the bar has been designed to speed up the operator's work, respecting the section of the bar and the functions of the rear lamp. Quick change and replacement of the rear light and bulbs.

Il concetto dell'applicazione sulla barra è stato studiato per velocizzare il lavoro dell'operatore, rispettando la sezione della barra e le funzioni del fanale.
Rapido cambio e sostituzione del fanale e delle lampadine.

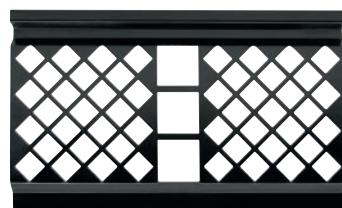

Black painted protective grill for Piaggio Porter NP6

Griglia parasassi Piaggio Porter NP6 verniciata nero
attacco barra

ARTICLE	L	H	P	SP	KG	
V10222	330	205	60	15/10	0,97	2

i The application on the bar has been designed to speed up the operator's work, respecting the section of the bar and the functions of the rear lamp. Quick change and replacement of the rear light and bulbs.

Il concetto dell'applicazione sulla barra è stato studiato per velocizzare il lavoro dell'operatore, rispettando la sezione della barra e le funzioni del fanale.
Rapido cambio e sostituzione del fanale e delle lampadine.

Corner edged single axle mudguard
Parafango spigolato asse singolo

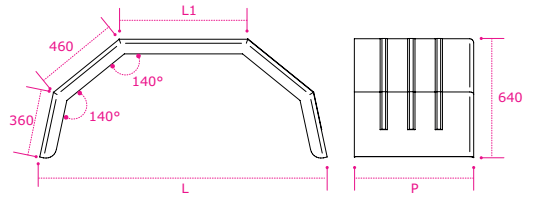

ARTICLE	L	L1	P	SP	KG	
FP22000	1400	520	650	18/10	22,50	30

i Special sizes on request.
 Su richiesta si realizzano misure personalizzate.

Corner edged multi axle mudguard
Parafango spigolato doppio asse

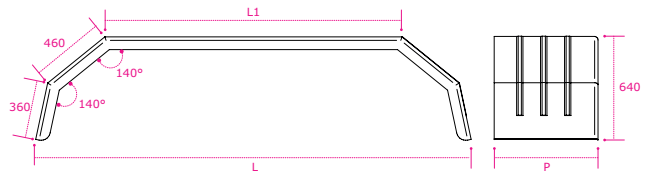
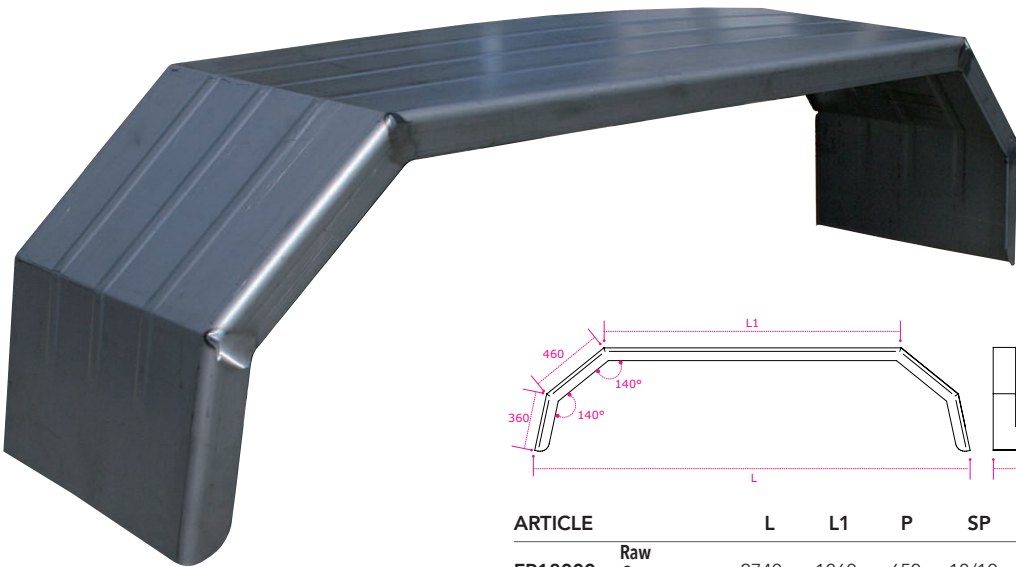

ARTICLE		L	L1	P	SP	KG	
FP18000	Raw Grezzo	2740	1860	650	18/10	39,60	15

i Raw steel and black painted mudguard, RAL 7021, edged, double axle for work vehicles, special sizes on request.
 Parafango acciaio grezzo e verniciato nero, RAL 7021, spigolato, doppio asse per mezzi d'opera, su richiesta misure particolari.

Almond stainless steel corner edged single axle mudguard 3+1
Parafango spigolato singolo asse inox mandorlato 3+1

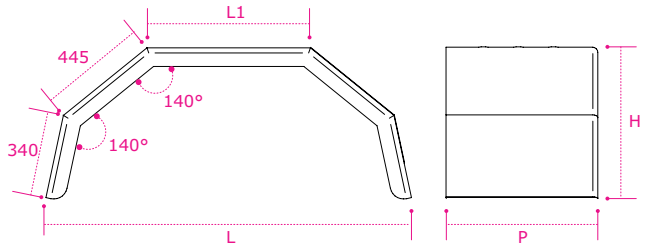
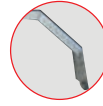
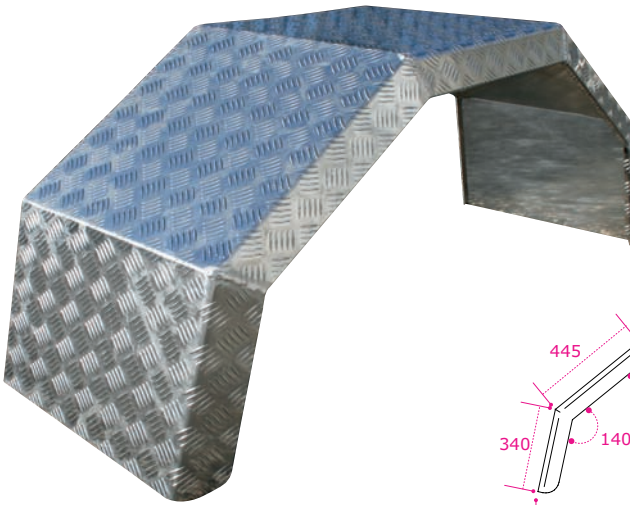

i Special sizes on request.
 Su richiesta si realizzano misure personalizzate.

ARTICLE	L	L1	P	SV	SP	KG	N.
AL50014	1300	440	450	2010	30/10	8,65	30

Almond stainless steel corner edged single axle mudguard 3+1
Parafango spigolato singolo asse inox mandorlato 3+1

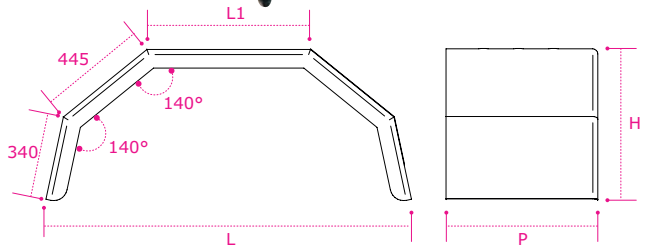
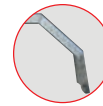
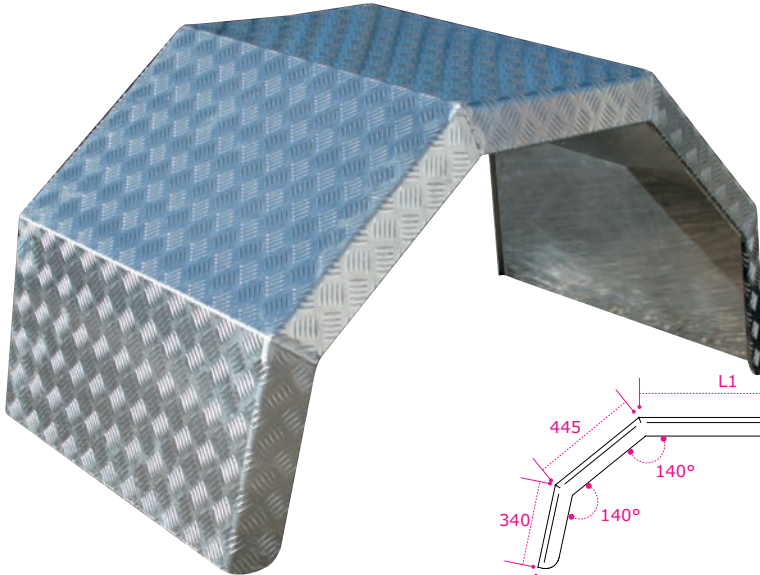



i Special sizes on request.
 Su richiesta si realizzano misure personalizzate.

ARTICLE	L	L1	P	SV	SP	KG	N.
AL50016	1300	440	690	2010	30/10	12,95	30

MUDGUARDS

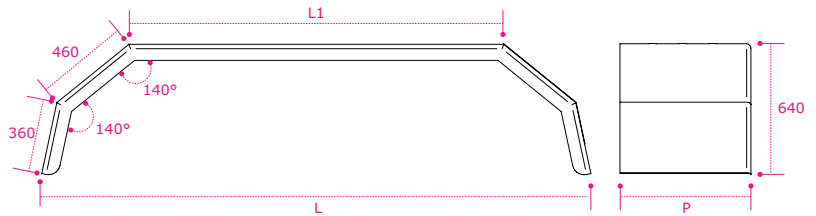
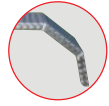
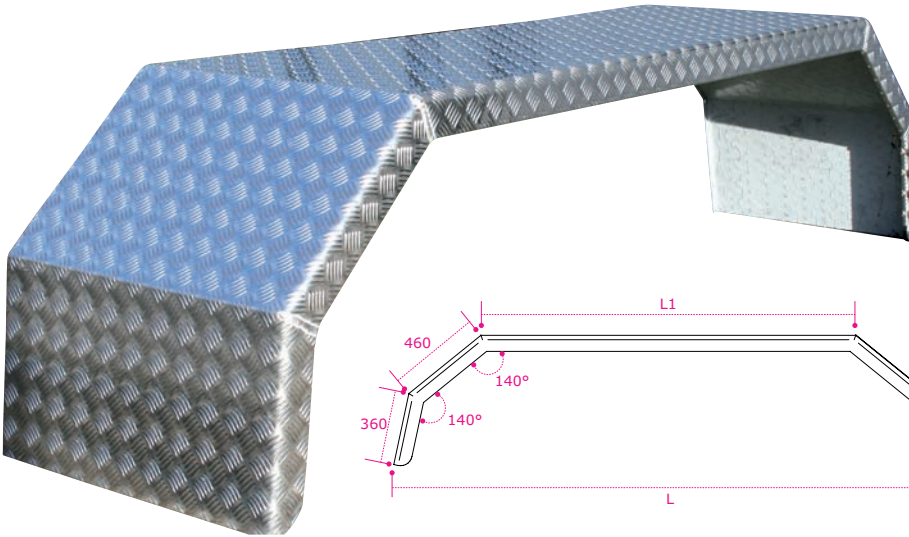
Alluminum almond corner edged multi axle mudguard Parafango spigolato doppio asse in alluminio mandorlato



ARTICLE	L	L1	P	SP	KG	
AL18000	2740	1860	650	30/10	22,00	15

i Special sizes on request.
Su richiesta si realizzano misure personalizzate.

Flowered stainless steel corner edged multi axle mudguard Parafango spigolato doppio asse inox fiorettato

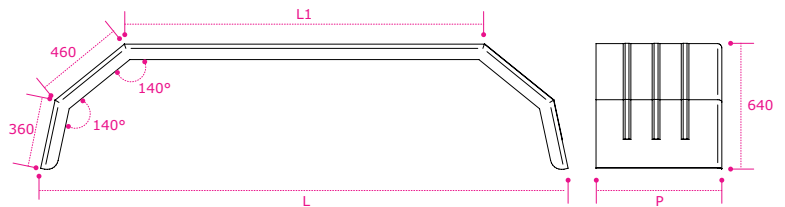
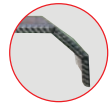
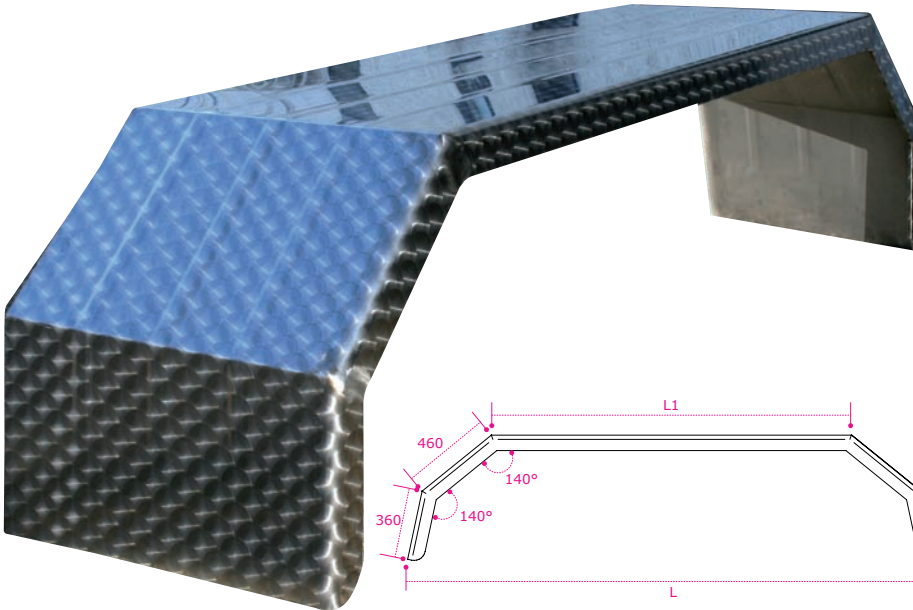



ARTICLE	L	L1	P	SP	KG	
IF18000	2740	1860	650	15/10	30,00	15

i Special sizes on request.
Su richiesta si realizzano misure personalizzate.

Flowered steel mudguard fixing Ø42

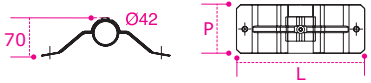
Aletta supporto inox fiore Ø42



ARTICLE	D	L	P	KG	
Q100108	42	230	80	0,29	1

Flowered steel mudguard fixing Ø54

Aletta supporto inox fiore Ø54

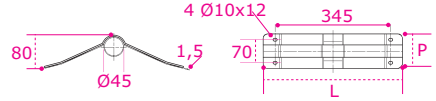

ARTICLE	D	L	P	KG	
Q100107	54	400	105	0,54	1

Galvanized mudguard fixing Ø42

Aletta supporto zincata Ø42

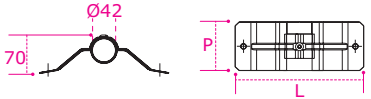

ARTICLE	D	L	P	KG	
Q100106	42	230	80	0,29	1

Galvanized mudguard fixing Ø54

Aletta supporto zincata Ø54

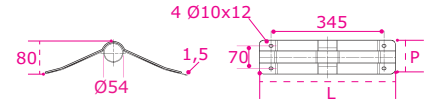

ARTICLE	D	L	P	KG	
P60046	54	400	105	0,54	1

Raw steel mudguard fixing Ø42

Aletta supporto acciaio grezzo Ø42

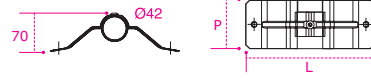

ARTICLE	D	L	P	KG	
Q100105	42	230	80	0,29	1

Raw steel mudguard fixing Ø54

Aletta supporto acciaio grezzo Ø54

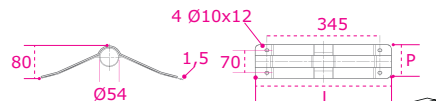

ARTICLE	D	L	P	KG	
P60045	54	400	105	0,54	1

Screws kit for steel mudguard fixing

Kit viti - alette acciaio



ARTICLE	D	L	KG	
R70120	8	25	0,16	1

Screws kit for pvc mudguard fixing

Kit viti - alette pvc



ARTICLE	D	L	KG	
R70121	8	25	0,12	1

Rivets kit for pvc mudguard fixing

Kit rivetti - alette pvc



ARTICLE	D	L	KG	
R70125	7,8	18	0,12	1

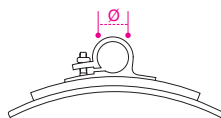
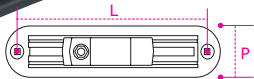
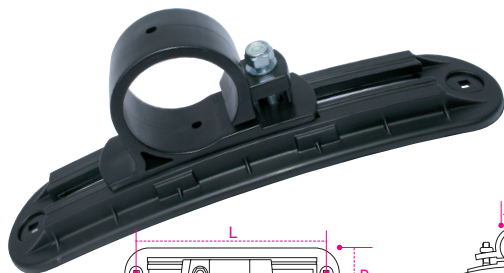

Pvc adjustable mudguard fixing

Aletta regolabile pvc

ARTICLE	D	L	P	KG	
Q100109	42	260	70	0,28	50
Q100119	48	260	70	0,29	50
Q100110	54	260	70	0,29	50

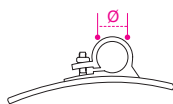
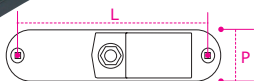
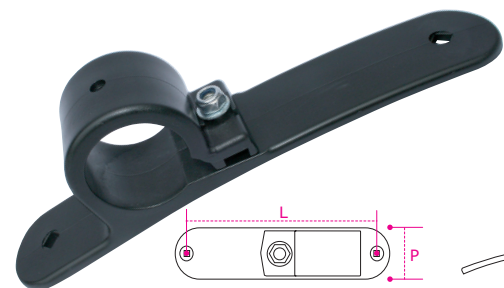

Pvc not adjustable mudguard fixing

Aletta supporto fisso pvc

ARTICLE	D	L	P	KG	
P50042	42	140	50	0,13	100
P50054	54	220	50	0,13	100

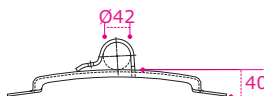
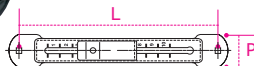

Black painted adjustable mudguard fixing

Aletta regolabile verniciata nero

ARTICLE	D	L	P	KG	
P600411	42	310	50	0,47	50

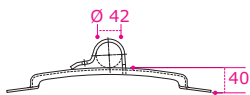
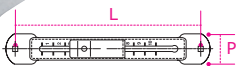
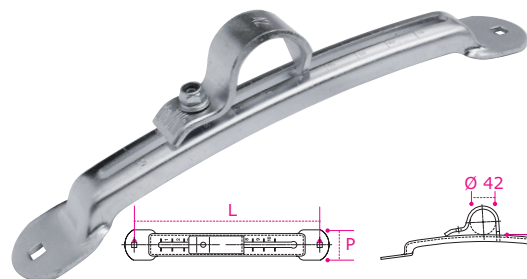

Galvanized adjustable mudguard fixing

Aletta regolabile zincata

ARTICLE	D	L	P	KG	
P60041	42	310	50	0,47	50

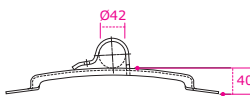
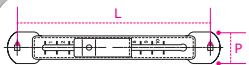
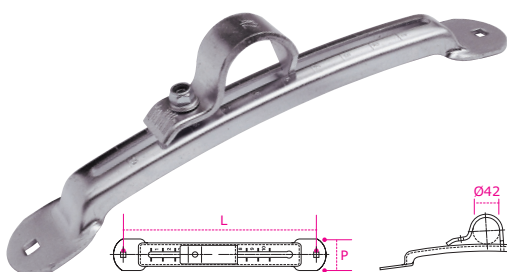

Stainless steel adjustable mudguard fixing

Aletta regolabile inox

ARTICLE	D	L	P	KG	
P60042	42	310	50	0,47	50

ACCESSORIES FOR MUDGUARDS

Cut 45° curved tube Ø42

Tubo curvo taglio 45° Ø42

ARTICLE		D	L	SP	KG	
P60033	Raw Grezzo	42	790	2	1,67	100
P60034	Galvanized Zincato	42	790	2	1,67	100
P60035	Stainless Steel Inox	42	790	2	1,67	100

Cut 45° curved tube Ø54

Tubo curvo taglio 45° Ø54

ARTICLE		D	L	SP	KG	
P60030	Raw Grezzo	54	790	2	2,15	100
P60031	Galvanized Zincato	54	790	2	2,15	100
P60032	Stainless Steel Inox	54	790	2	2,15	100
P6003030	Raw Grezzo	54	790	3	3,20	100
P6003130	Galvanized Zincato	54	790	3	3,20	100

Mudguard fixing kit cut 45° curved tube Ø42

Staffa completa tubo curvo taglio 45° Ø42

ARTICLE		D	L	SP	KG	
P600330	Raw Grezzo	42	790	2	2,90	100
P600340	Galvanized Zincato	42	790	2	2,90	100
P600350	Stainless Steel Inox	42	790	2	2,90	100

Mudguard fixing kit cut 45° curved tube Ø54

Staffa completa tubo curvo taglio 45° Ø54

ARTICLE		D	L	SP	KG	
P600300	Raw Grezzo	54	790	2	3,20	100
P600310	Galvanized Zincato	54	790	2	3,20	100
P600320	Stainless Steel Inox	54	790	2	3,20	100
P60030030	Raw Grezzo	54	790	3	4,30	100
P60031030	Galvanized Zincato	54	790	3	4,30	100

Reinforced galvanized mudguard support Ø42 - 4 holes

Staffa supporto 4 fori zincata rinforzata Ø42

ARTICLE	D	L	L1	H1	SP	KG	
Q100132	42	760	85	105	2	1,75	20

TK  **cert** RINA UNI EN ISO 15614-1:2012

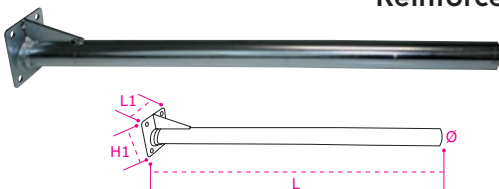

ACCESSORIES FOR MUDGUARDS

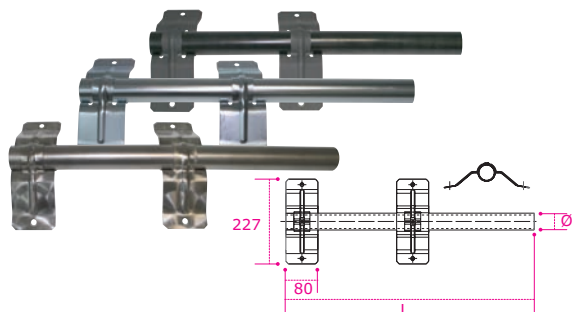

Mudguard fixing kit Ø42

Staffa completa Ø42

ARTICLE		D	L	SP	KG	
P60010	Raw Grezzo	42	600	2	1,5	100
P60011	Galvanized Zincato	42	600	2	1,5	100
P60012	Flowered SS Inox Fiore	42	600	2	1,5	100

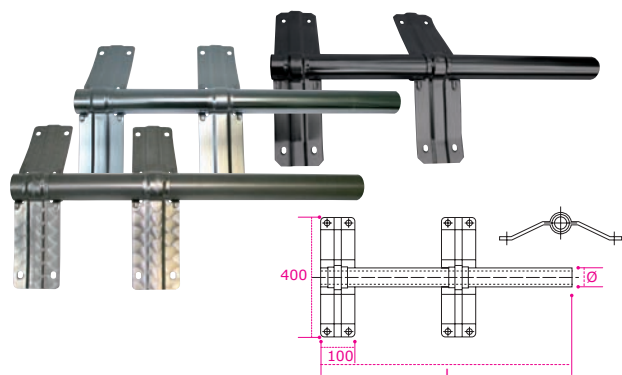

Mudguard fixing kit Ø54

Staffa completa Ø54

ARTICLE		D	L	SP	KG	
P60020	Raw Grezzo	54	760	2	3,20	100
P60021	Galvanized Zincato	54	760	2	3,20	100
P60023	Flowered SS Inox Fiore	54	760	2	3,20	100
P6002030	Raw Grezzo	54	760	3	4,30	100
P6002130	Galvanized Zincato	54	760	3	4,30	100

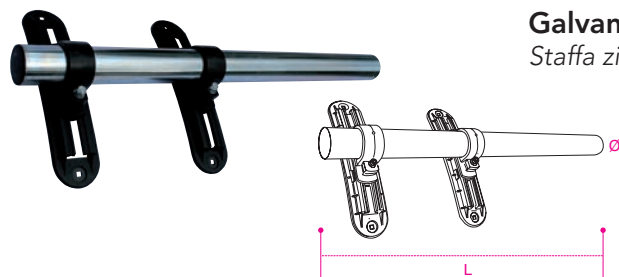

Galvanized tube with adjustable pvc support

Staffa zincata con alette pvc regolabili

ARTICLE	D	L	SP	KG	
P90026	42	600	2	1,40	1
P90025	54	760	2	1,40	1

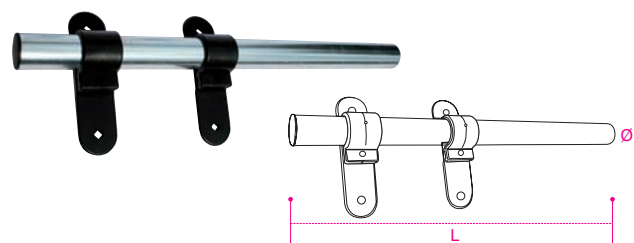

Galvanized tube with pvc support

Staffa zincata con alette pvc fisse

ARTICLE	D	L	SP	KG	
P90028	42	600	2	1,10	1
P90029	48	760	2,7	1,40	1
P90030	54	760	2	1,50	1

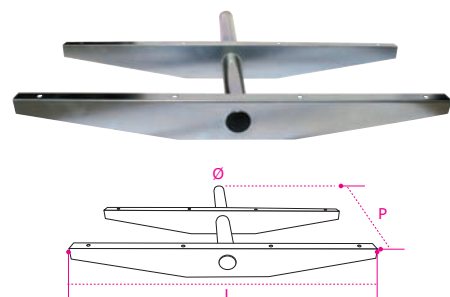

Central support for mudguard double axle

Supporto centrale per parafanghi doppio asse

ARTICLE		D	L	P	SP	KG	
P600321	Galvanized Zincato	54	750	970	2	4,60	2
P600322	Stainless Steel Inox	54	750	970	2	4,60	2
P60032130	Galvanized Zincato	54	750	970	3	5,70	2

Straight tube *Tube dritto*

ARTICLE		D	L	SP	KG	
Q100096Z	Galvanized Zincato	42	600	2	1,00	100
Q100098G	Raw Grezzo	42	760	2	1,20	100
Q100098	Galvanized Zincato	42	760	2	1,20	100
Q100099	Black Nero	42	760	2	1,20	100
Q100144	Stainless Steel Inox	42	600	2	1,00	100
Q100141	Raw Grezzo	42	800	2,5	1,94	100
Q100142	Black Nero	42	800	2,5	1,94	100
Q100143	Galvanized Zincato	42	800	2,5	1,94	100
Q200099	Black Nero	48	800	2,7	1,60	100
Q200100	Galvanized Zincato	48	800	2,7	1,60	100
Q100100G	Raw Grezzo	54	760	2	1,98	100
Q100100	Galvanized Zincato	54	760	2	1,98	100
Q100097	Stainless Steel Inox	54	760	2	1,98	100
Q100121	Black Nero	54	760	2	1,98	100
Q100130G	Raw Grezzo	54	760	3	2,98	100
Q10010030	Galvanized Zincato	54	760	3	2,98	100



Curved tube *Tube curvo*

ARTICLE		D	L	SP	KG	
M10002	Black Nero	42	760	2	1,42	100
M100013	Stainless Steel Inox	42	760	2	1,42	100
M10006	Galvanized Zincato	42	760	2	1,42	100
M10015	Black Nero	42	800	2,5	1,80	100
M10016	Galvanized Zincato	42	800	2,5	1,80	100
M20003	Black Nero	48	800	2,7	1,95	100
M20006	Galvanized Zincato	48	800	2,7	1,80	100



Straight tube for chassis *Tube dritto attacco chassis*

ARTICLE		D	L	SP	KG	
Q100113	Black Nero	42	760	2	1,60	100
M100123	Black Nero	42	450	2	1,90	100
Q100127	Stainless Steel Inox	42	760	2	1,90	100
Q100104	Galvanized Zincato	42	760	2	1,60	100
TKcert RINA UNI EN ISO 15614-1:2012						
Q100114	Black Nero	42	800	2,5	1,90	100
M100126	Galvanized Zincato	42	800	2,5	1,90	100
TKcert RINA UNI EN ISO 15614-1:2012						
Q200114	Black Nero	48	800	2,7	2,00	100
Q200104	Galvanized Zincato	48	800	2,7	1,90	100



TKcert RINA UNI EN ISO 15614-1:2012

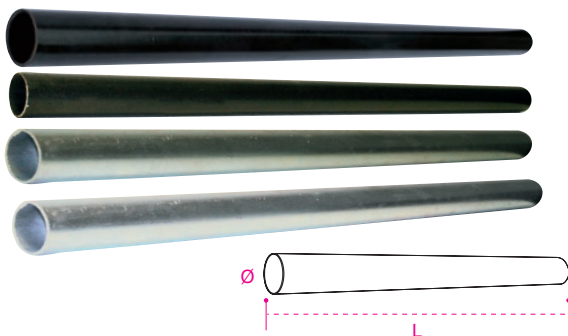

i Ø42x2 indicated for industrial or commercial vehicles with a maximum capacity of 80 quintals. Ø42x2.5 indicated for industrial vehicles, tractors and trailers Ø48x2,7 and Ø54x2. TOP RANGE indicated for earthmoving machinery, roll-off tractors and gully clearers. Ø42x2 indicato per Veicoli Commerciali o Industriali con portata max 80q.li. Ø42x2,5 indicato per tutti i Veicoli Industriali, Motrici e Rimorchi. Ø48x2,7 and Ø54x2. TOP GAMMA indicato per Cavacantiere, Scarrabili, Motrici e Autospurghi.

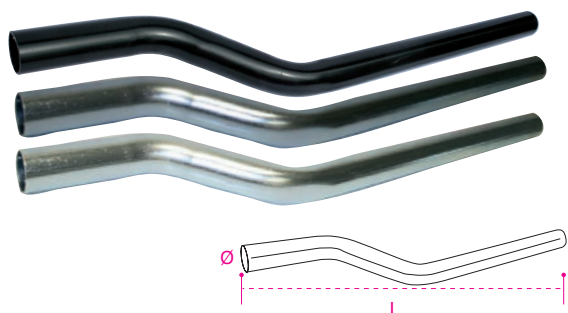

i Ø42x2 indicated for industrial or commercial vehicles with a maximum capacity of 80 quintals. Ø42x2.5 indicated for industrial vehicles, tractors and trailers Ø48x2,7 and Ø54x2. TOP RANGE indicated for earthmoving machinery, roll-off tractors and gully clearers. Ø42x2 indicato per Veicoli Commerciali o Industriali con portata max 80q.li. Ø42x2,5 indicato per tutti i Veicoli Industriali, Motrici e Rimorchi. Ø48x2,7 and Ø54x2. TOP GAMMA indicato per Cavacantiere, Scarrabili, Motrici e Autospurghi.

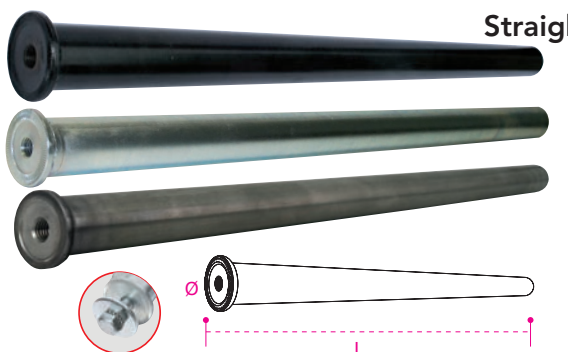

i Ø42x2 indicated for industrial or commercial vehicles with a maximum capacity of 80 quintals. Ø42x2.5 indicated for industrial vehicles, tractors and trailers Ø48x2,7 and Ø54x2. TOP RANGE indicated for earthmoving machinery, roll-off tractors and gully clearers. Ø42x2 indicato per Veicoli Commerciali o Industriali con portata max 80q.li. Ø42x2,5 indicato per tutti i Veicoli Industriali, Motrici e Rimorchi. Ø48x2,7 and Ø54x2. TOP GAMMA indicato per Cavacantiere, Scarrabili, Motrici e Autospurghi.

Curved tube for chassis *Tube curvo attacco chassis standard*

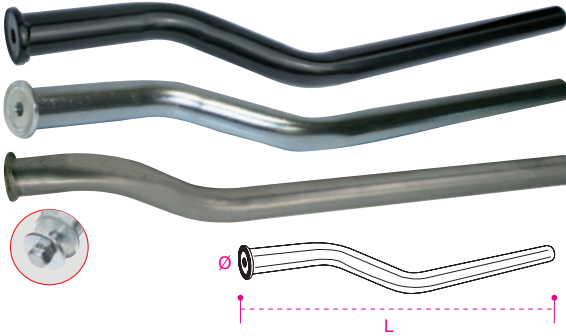

ARTICLE		D	L	SP	KG	
M10004	Black Nero	42	760	2	1,70	100
M10008	Galvanized Zincato	42	760	2	1,70	100
Q100128	Stainless Steel Inox	42	760	2	3,15	100
M10014	Galvanized Zincato	42	800	2,5	2,05	100
M10009	Black Nero	42	800	2,5	2,05	100
Q20004	Black Nero	48	800	2,7	3,15	100
Q20008	Galvanized Zincato	48	800	2,7	3,15	100

TKcertRINA UNI EN ISO 15614-1:2012

Curved tube for chassis *Tube curvo attacco chassis*

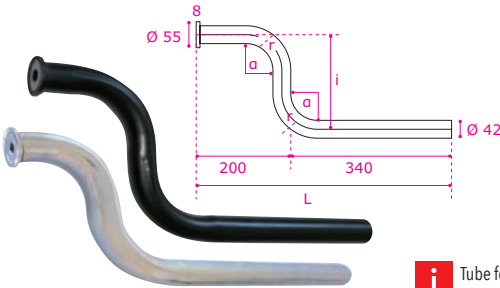

ARTICLE		D	L	i	αr	SP	KG	
M10020	Black Nero	42	540	200	90°r60	2,5	1,40	1
M10021	Galvanized Zincato	42	540	200	90°r60	2,5	1,40	1

TKcertRINA UNI EN ISO 15614-1:2012

i Tube for trailers and semi-trailers, ex Viberti model, double tight "S" curves, 90° fold angle and 60 radius diameter fold, inter-axis distance 200mm, indicated for P50014 and P50015. Tubo per rimorchi e semirimorchi, mod. ex Viberti, doppia curva stretta ad "S" angolo curvatura 90° e diametro raggio curvatura 60, distanza interasse 200 mm indicato per P50014 e P50015.

Curved tube straight radius

Tube curvo a raggiatura stretta

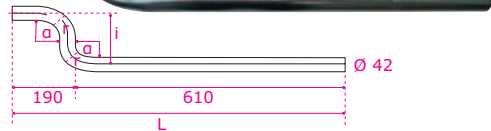

ARTICLE		D	L	i	αr	SP	KG	
Q100135	Black Nero	42	800	80	90°r60	2,5	1,95	1
Q100153	Galvanized Zincato	42	800	80	90°r60	2,5	1,95	1

Curved tube straight radius for chassis *Tube curvo raggio stretto attacco chassis*

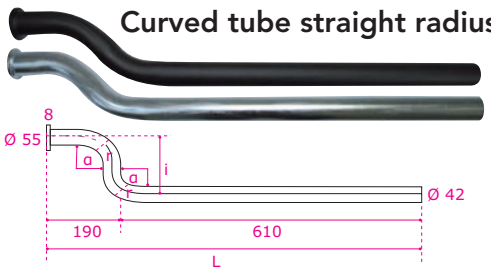

ARTICLE		D	L	i	αr	SP	KG	
Q100152	Black Nero	42	800	80	90°r60	2,5	2,10	1
Q100154	Galvanized Zincato	42	800	80	90°r60	2,5	2,10	1

TKcertRINA UNI EN ISO 15614-1:2012

Straight tube triangular connection $\text{Ø}42$ *Tube dritto attacco triangolo $\text{Ø}42$*

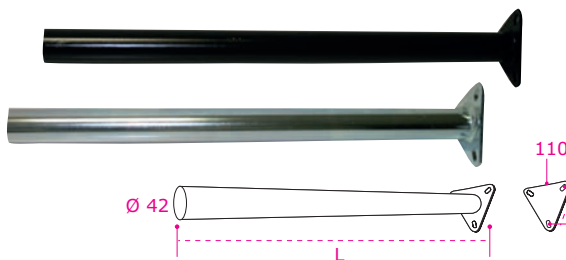

ARTICLE		D	L	SP	KG	
Q100134	Black Nero	42	480	2	1,66	100
Q100115	Black Nero	42	750	2	2,16	100
Q100118	Galvanized Zincato	42	480	2	1,38	100
Q100120	Galvanized Zincato	42	600	2	1,66	100
Q100117	Galvanized Zincato	42	750	2	2,16	100

TKcertRINA UNI EN ISO 15614-1:2012

ACCESSORIES FOR MUDGUARDS

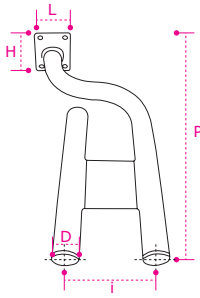

Black painted central support double mudguard - small

Supporto centrale doppio parafrango stretto verniciato nero

ARTICLE	L	H	P	D	SP	i	ar	KG	
Q100148	85	105	520	42	2	120	90°r60	2,35	1



TKcertRINA UNI EN ISO 15614-1:2012

i Central support double mudguard for trailers and semi-trailers, double tight "S" curves, 90° fold angle and 60 radius diameter fold, inter-axis distance 120mm, exclusively indicated for attaching to P60041 and P600411.
Supporto centrale doppio parafrango per rimorchi e semirimorchi, doppia curva stretta ad "S" angolo curvatura 90° e diametro raggio curvatura 60, distanza interasse 120

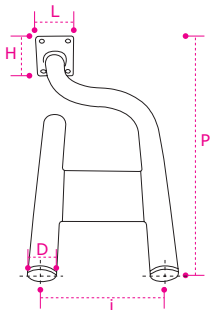

Black painted central support double mudguard - medium

Supporto centrale doppio parafrango medio verniciato nero

ARTICLE	L	H	P	D	SP	i	ar	KG	
Q100149	85	105	520	42	2	180	90°r60	2,60	1



TKcertRINA UNI EN ISO 15614-1:2012

i Central support double mudguard for trailers and semi-trailer, double tight "S" curves, 90° fold angle and 60 radius diameter fold, inter-axis distance 120mm, exclusively indicated for attaching P60041 and P600411.
Supporto centrale doppio parafrango per rimorchi e semirimorchi, doppia curva stretta ad "S" angolo curvatura 90° e diametro raggio curvatura 60, distanza interasse 120 mm indicato esclusivamente per alette P60041 e P600411.

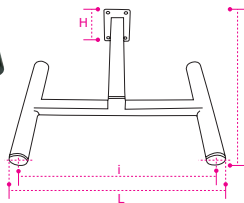

Black painted central support double mudguard - large

Supporto centrale doppio parafrango largo verniciato nero

ARTICLE	L	H	P	D	SP	i	KG	
Q100150	122	85	520	42	2	440	3,05	1



TKcertRINA UNI EN ISO 15614-1:2012

i Large central support double mudguard for tractors, trailers and semi-trailers, inter-axis distance 440mm indicated for attaching with a diameter of 42. Supporto centrale doppio parafrango largo per motrici, rimorchi e semirimorchi, distanza interasse 440 mm indicato per tutti i modelli di alette diam. 42.

Pvc caps for tubes Tappo per tubi

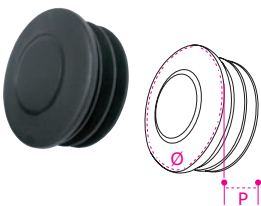

ARTICLE	D	P	KG	
P60004	25	15	0,004	50
P60014	42	25	0,015	50
P60024/1	48	29	0,022	50
P60024	54	26	0,025	50

Pvc caps tappo quadro pvc

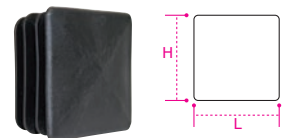

ARTICLE	L	H	KG	
110318202N	40	40	0,08	1

FIXING BRACKETS

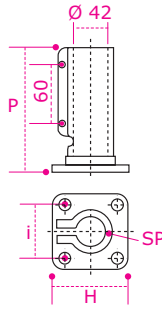

Galvanized standard fixing bracket 4 holes Ø42

Calice standard 4 fori Ø42 zincato

ARTICLE	D	H	P	SP	i	KG	
P60051	42	85	130	1,5	60	0,62	50

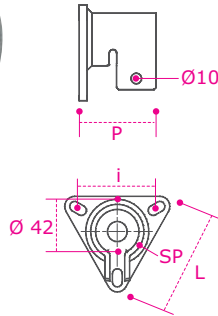
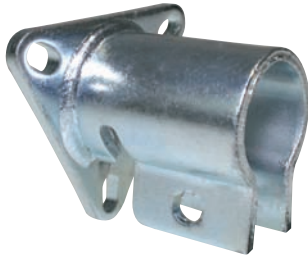

Galvanized Ø42 fixing bracket with triangular plate

Calice Ø42 zincato piastra triangolo

ARTICLE	D	L	P	SP	i	KG	
P600511	42	105	80	7	80	0,85	50

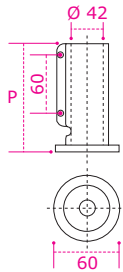

Galvanized fixing bracket Ø42 plate with bolt

Calice Ø42 zincato piastra con bullone

ARTICLE	D	P	PA	i	KG	
P600512	42	135	80	80	0,85	50

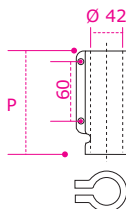

Raw Ø42 fixing bracket to welded

Calice Ø42 grezzo a saldare

ARTICLE	D	P	KG	
P60055/2	42	130	0,39	50

FIXING BRACKETS

Standard fixing bracket Ø54

Calice standard Ø54

ARTICLE		D	L	SP	KG	
P60059	Galvanized Zincato	54	190	2,5	0,70	50
P60058	Raw Grezzo	54	190	2,5	0,70	50

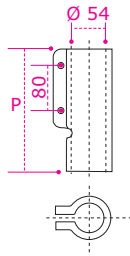

Standard fixing bracket with plate 4 holes Ø54

Calice standard con piastra 4 fori Ø54

ARTICLE		D	H	P	SP	i	KG	
P60056	Galvanized Zincato	54	90	190	2,5	65	0,86	50
P60054	Raw Grezzo	54	90	190	2,5	65	0,86	50

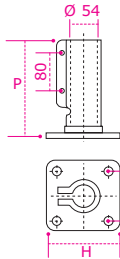

 RINA UNI EN ISO 15614-1:2012

Raw reinforced fixing bracket Ø54 to welded

Calice grezzo rinforzato Ø54 a saldare

ARTICLE	D	H	P	SP	KG	
P60055/1	54	130	190	2,5	0,92	50

 RINA UNI EN ISO 15614-1:2012

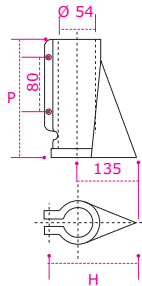

Galvanized reinforced fixing bracket Ø54 with plate

Calice rinforzato Ø54

con piastra e fazzoletto zincato

ARTICLE	D	L	H	P	i	SP	KG	
P600531	54	85	120	190	95/55	2,5	1,15	50

 RINA UNI EN ISO 15614-1:2012

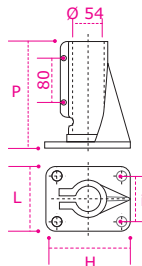
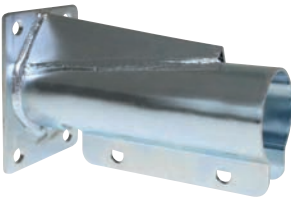

Galvanized reinforced fixing bracket Ø54

Calice Ø54 rinforzato zincato

ARTICLE	D	L	H	P	i	SP	KG	
P60052	54	90	120	140	65	2	0,96	50

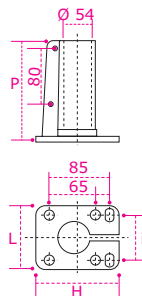

FIXING BRACKETS

Stainless steel fixing bracket 4 holes AISI 304

Calice standard 4 fori Ø54 inox AISI 304





ARTICLE		D	P	SP	KG	
IN60058	Standard Liscio	54	190	2	0,70	50
IF60058	Flowered Fiorettato	54	190	2	0,70	50

TKcert RINA UNI EN ISO 15614-1:2012

Stainless steel fixing bracket with plate 4 holes AISI 304

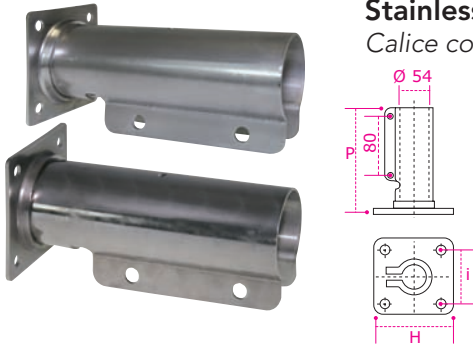
Calice con piastra 4 fori Ø54 inox AISI 304





ARTICLE		D	H	P	SP	i	KG	
IN60054	Standard Liscio	54	90	190	2	65	0,86	50
IF60054	Flowered Fiorettato	54	90	190	2	65	0,86	50

TKcert RINA UNI EN ISO 15614-1:2012

Stainless steel reinforced fixing bracket 4 holes AISI 304 to welded

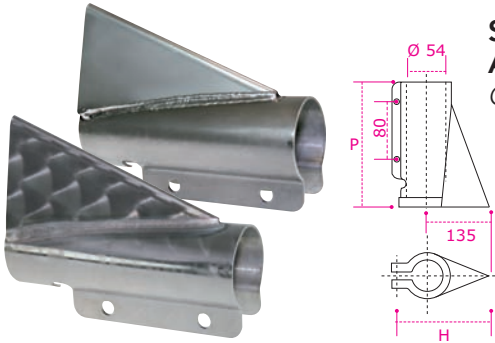
Calice rinforzato 4 fori Ø54 inox AISI 304 a saldare





ARTICLE		D	H	P	SP	KG	
IN600551	Standard Liscio	54	130	190	2	0,86	50
IF600551	Flowered Fiorettato	54	130	190	2	0,86	50

TKcert RINA UNI EN ISO 15614-1:2012

Stainless steel reinforced fixing bracket with plate 4 holes AISI 304

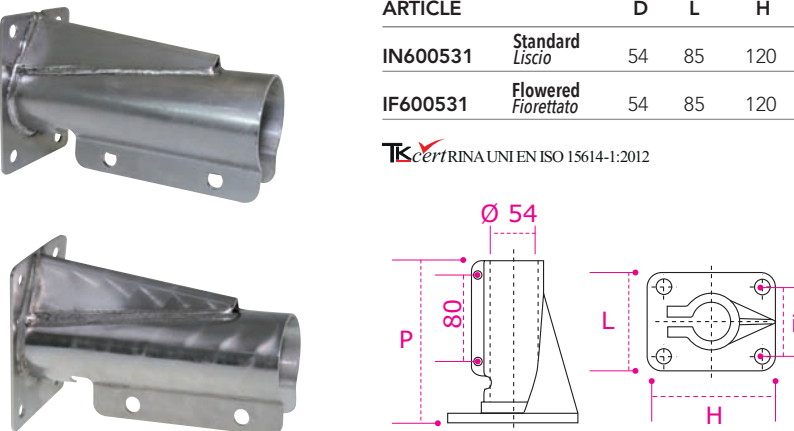
Calice rinforzato 4 fori con piastra Ø54 inox AISI 304



ARTICLE		D	L	H	P	SP	i	KG	
IN600531	Standard Liscio	54	85	120	190	2	95/55	1,15	50
IF600531	Flowered Fiorettato	54	85	120	190	2	95/55	1,15	50

TKcert RINA UNI EN ISO 15614-1:2012



LADDERS

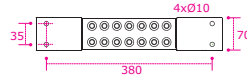
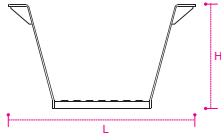

Galvanized step

Gradino zincato

ARTICLE	L	H	KG	
R10110	405	240	1,25	10

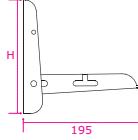
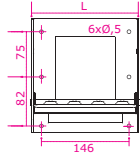

Galvanized step

Gradino zincato

ARTICLE	L	H	KG	
R11111	172	190	1,20	10

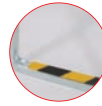
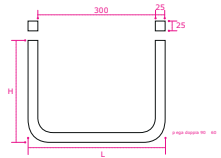

Stainless steel step

Gradino di salita inox

ARTICLE	L	H	SP	KG	
R10109	350	260	20/10	0,86	1

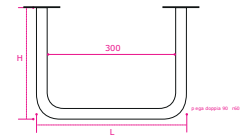

Stainless steel step with inwards plate

Gradino di salita inox con staffe interne

ARTICLE	L	H	SP	KG	
R10107	350	260	20/10	0,95	1

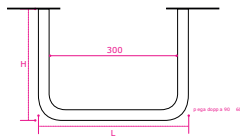
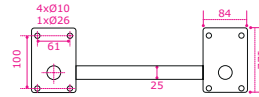

Stainless steel step with outwards plate

Gradino di salita inox con staffe esterne

ARTICLE	L	H	SP	KG	
R10108	350	260	20/10	0,95	1

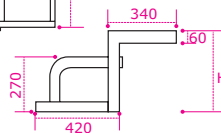
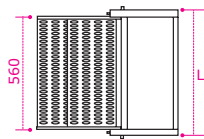

Galvanized retractable ladder

Scaletta di salita retrattile zincata

ARTICLE	L	H	P	KG	
V30054	620	330	340	37,50	1

LADDERS

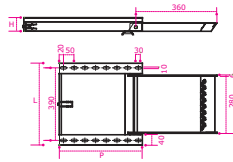

Galvanized extractable ladder one step *Scaletta zincata estraibile un gradino*

ARTICLE	L	H	P	KG	
V10050	420	60	370	4,50	10

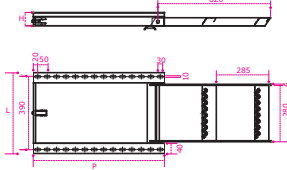

Galvanized extractable ladder two steps *Scaletta zincata estraibile due gradini*

ARTICLE	L	H	P	KG	
V10051	420	60	660	7,60	10

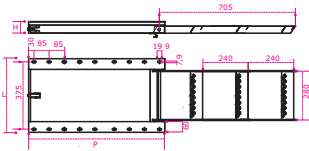
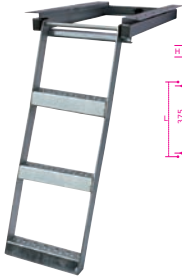

Galvanized extractable ladder three steps *Scaletta zincata estraibile tre gradini*

ARTICLE	L	H	P	KG	
V100510	420	60	750	8,50	10

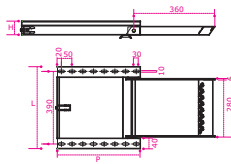

Stainless steel extractable ladder one step *Scaletta inox estraibile un gradino*

ARTICLE	L	H	P	KG	
IF10050	420	60	370	4,50	10

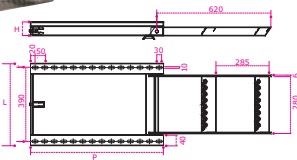
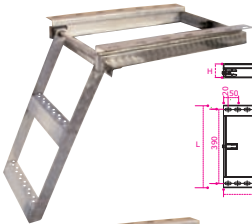

Stainless steel extractable ladder two steps *Scaletta inox estraibile due gradini*

ARTICLE	L	H	P	KG	
IF10051	420	60	660	7,60	10

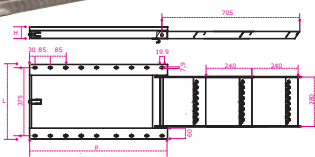

Stainless steel extractable ladder three steps *Scaletta inox estraibile tre gradini*

ARTICLE	L	H	P	KG	
IF100510	420	60	750	8,50	10

Connecting clip for ladder *Clip innesto per scaletta*

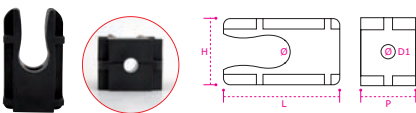

ARTICLE	L	H	P	D	D1	KG	
V10056	53	31	25	14	6,5	0,024	1

Tread sliding rail for ladder *Rotaia scorrimento pedata per scaletta*

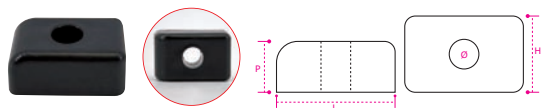

ARTICLE	L	H	P	D	KG	
V168680	56	36	24	14	8,50	1

LADDERS

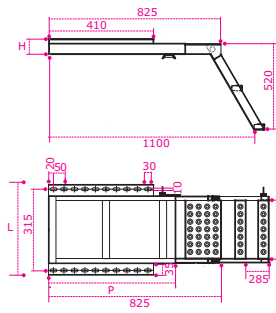

Galvanized extractable ladder two steps with platform

Scaletta zincata estraibile due gradini con pedana

ARTICLE	L	H	P	KG	
R30270	380	60	530	8,70	1

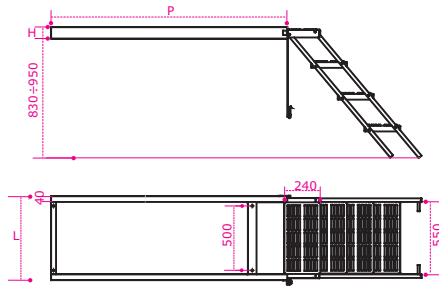
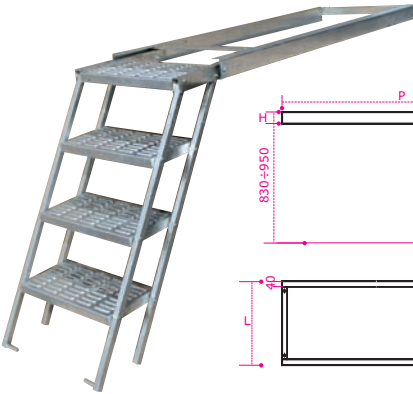

Galvanized extractable ladder four steps

Scaletta zincata estraibile quattro gradini

ARTICLE	L	H	P	KG	
V30050	635	80	1780	36,50	1

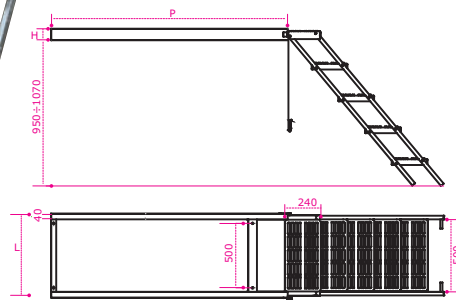
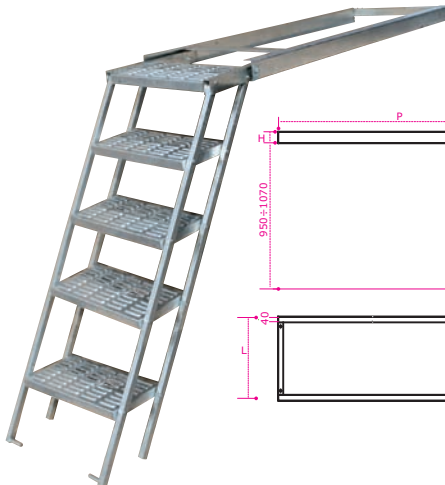

Galvanized extractable ladder five steps

Scaletta zincata estraibile cinque gradini

ARTICLE	L	H	P	KG	
V30051	635	80	2060	42,50	1

**Body mounting brackets
Kit with spring**

Kit falso telaio con molla assemblato



**Body mounting brackets
Kit for Scania e Volvo**

Kit falso telaio Scania e Volvo



Raw Body Mounting Brackets for Volvo
Supporto Volvo Grezzo

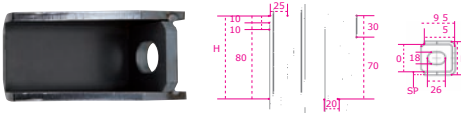

TKcertRINA UNI EN ISO 15614-1:2012

ARTICLE	L	H	SP	KG	
R17130	50	100	5	0,65	1

Raw body mounting Brackets for scania
Supporto Scania grezzo

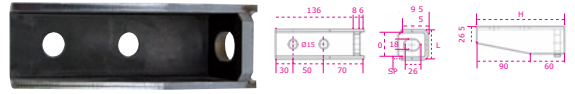

TKcertRINA UNI EN ISO 15614-1:2012

ARTICLE	L	H	SP	KG	
R17132	50	150	5	0,79	1

**Raw body mounting brackets
without holes**

Supporto universale senza fori

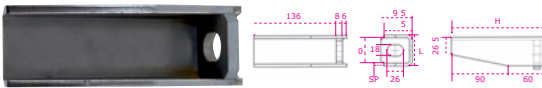

TKcertRINA UNI EN ISO 15614-1:2012

ARTICLE	L	H	SP	KG	
R17132SF	50	150	5	0,80	1

**Raw body mounting
Brackets for Man**

Supporto falso telaio mod. Man

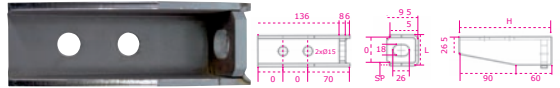

TKcertRINA UNI EN ISO 15614-1:2012

ARTICLE	L	H	SP	KG	
R17137	50	150	5	0,79	1

Raw body mounting bracket
Supporto grezzo standard

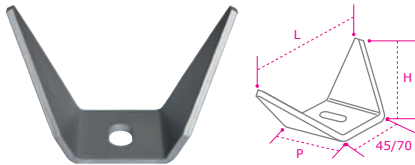

ARTICLE	L	H	P	SP	KG	
R13105	126	74	60	5	0,3	100
R1310	150	100	60	6	0,5	100
R13111	170	84	60	10	0,85	100

**Raw light body mounting
bracket reinforced**

Supporto grezzo leggero modello rinforzato

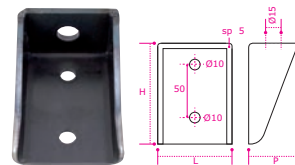

TKcertRINA UNI EN ISO 15614-1:2012

ARTICLE	L	H	P	SP	KG	
R17131	70	95	50	5	0,54	100

Raw body mounting bracket
Supporto grezzo falso telaio

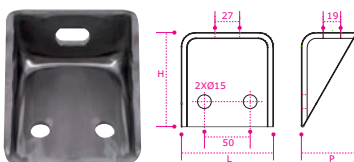

ARTICLE	L	H	P	SP	KG	
R78100	100	105	60	7	0,90	100

**Raw body mounting bracket
with transversal slot**
Supporto grezzo falso telaio con asola trasversale

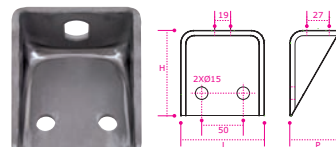

ARTICLE	L	H	P	SP	KG	
R78200	100	105	60	7	0,90	100

Sideguard support with slots

Supporto paracicli asolato

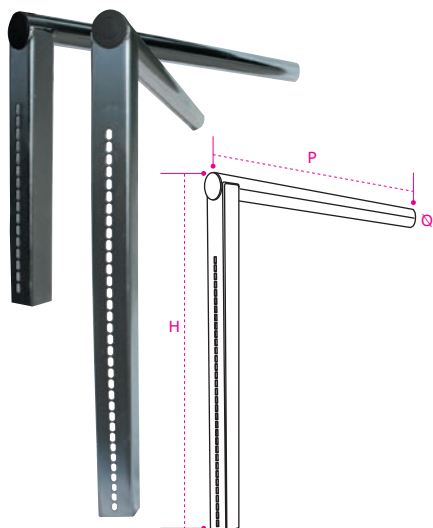

ARTICLE		D	H	P	KG	
V10107	Galvanized Zincato	42x2	470	600	3,60	100
V10113	Stainless Steel Inox	42x2	470	600	3,60	100





ARTICLE		D	H	P	KG	
V10106	Galvanized Zincato	54x2	735	800	4,30	100
V10114	Stainless Steel Inox	54x2	735	800	4,30	100

TKcert RINA UNI EN ISO 15614-1:2012

Tubular sideguard support

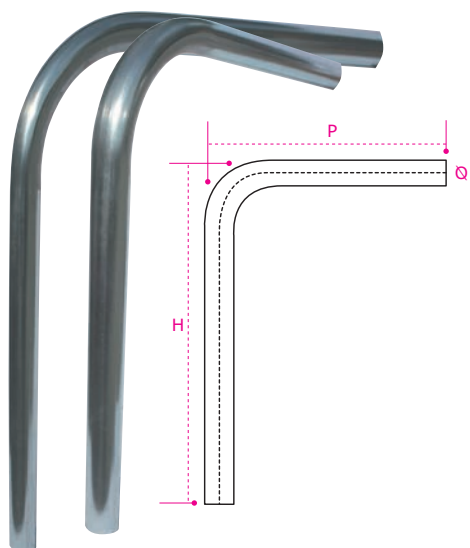
Supporto paracicli tubolare



ARTICLE		D	H	P	KG	
V10108	Galvanized Zincato	42x2	750	750	3,10	100
V10109	Stainless Steel Inox	42x2	750	750	3,10	100



ARTICLE		D	H	P	KG	
V10103	Galvanized Zincato	54x2	820	820	3,90	100
V10104	Stainless Steel Inox	54x2	820	820	3,90	100

Fixing band

Fascia fissaggio



ARTICLE		L	D	KG	
V30017	Galvanized Zincato	120	54	0,14	100
IN30017	Stainless Steel Inox	120	54	0,14	100

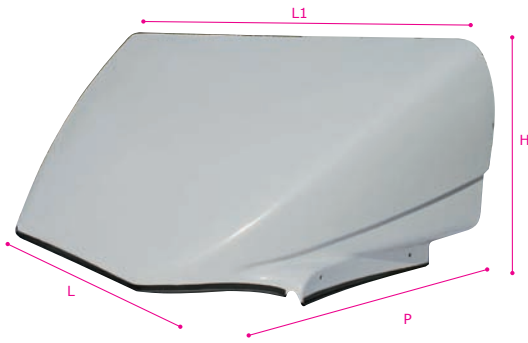

**Spoiler Daily >2000 - 2014
Master - Mascott - Movano <2009**

ARTICLE	L	L1	H	P	KG	
S935V	1600	1800	700	730	13,00	3



**Spoiler new Daily >07/2014
bonding fixing**
Ad incollaggio

ARTICLE	L	L1	H	P	KG	
SDI2014	1570	2000	705	830	14,50	3



Bonding Kit Included
Kit Incollaggio compreso

i Bonding spoiler, particularly recommended also for the fridge cut, reinforced grid on the central part and on all the external sides.
Spoiler ad incollaggio, particolarmente consigliato anche per la scantonatura frigo, essendo rinforzato a griglia su tutta la parte centrale e su tutti i fianchi esterni.



**Lowered spoiler Iveco Daily 07/2014>
bonding fixing**
Ad incollaggio

ARTICLE	L	L1	H	P	KG	
SDI2014R	1570	2000	370	800	14,00	3



Bonding Kit Included
Kit Incollaggio compreso



Spoiler Piaggio PORTER NP6

bonding fixing

Ad incollaggio

ARTICLE	L	H	P	KG	
S10039	1100	500	630	10,50	3



Spoiler new Ford >06/2014

bonding fixing

Ad incollaggio

ARTICLE	L	L1	H	P	KG	
S10014	1630	1980	720	800	14,50	3



Bonding Kit Included
Kit Incollaggio compreso

i Bonding spoiler, particularly recommended also for the fridge cut, reinforced grid on the central part and on all the external sides.
Spoiler ad incollaggio, particolarmente consigliato anche per la scantonatura frigo, essendo rinforzato a griglia su tutta la parte centrale e su tutti i fianchi esterni.



Spoiler Renault Master Mascott - Movano >2010 Nissan NV400 >2014

ARTICLE	L	L1	H	P	KG	
SM2010	1450	1880	680	810	13,50	3



Bonding Kit Included
Kit Incollaggio compreso



Spoiler Fiat Ducato >2006 Citroën Jumper Peugeot Boxer >2006



ARTICLE	L	L1	H	P	KG	
S10011	1440	1900	700	700	11,50	3



Bonding Kit Included
Kit Incollaggio compreso

Spoiler Mercedes Sprinter >2006 Volkswagen Crafter >2006 - 2017



ARTICLE	L	L1	H	P	KG	
S10016	1530	1920	700	800	11,50	3



Bonding Kit Included
Kit Incollaggio compreso

Spoiler Nissan NT500 >2014 Renault T >2014 Height Adjustable *Regolabile in altezza*



ARTICLE	L	L1	H	P	KG	
S10050	1850	1890	700-950	1030	24,00	3



Hardware Kit Included
Kit Ferramenta compreso

Spoiler Mitsubishi Canter >2005 Mitsubishi Canter FUSO FE >2017



ARTICLE	L	L1	H	P	KG	
S10013	1700	1940	780	970	13,80	1



Hardware Kit Included
Kit Ferramenta compreso

MUDFLAPS

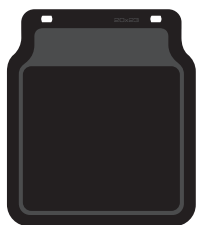

Neutral mudflap 200

Paraspruzzo neutro 200

ARTICLE	L	H	SP	KG	
S1720233	200	230	7	0,40	1

i Customized mudflaps are supplied with fixing bar and screws kit.
I paraspruzzi personalizzati vengono forniti completi di astine senza kit di fissaggio.
Consigliato per Piaggio Porter - Ruota Singola e Carrello Appendice

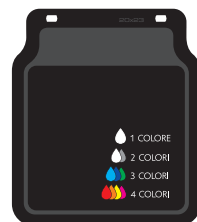

Customized mudflap 200

Paraspruzzo personalizzato 200

ARTICLE	COL	L	H	SP	KG	
S1720234	1	200	230	7	0,40	1
S1720235	2	200	230	7	0,40	1
S1720236	3	200	230	7	0,40	1
S1720237	4	200	230	7	0,40	1

i Customized mudflaps are supplied with fixing bar and screws kit. Recommended for Piaggio Porter, single wheel and appendix trolley.
I paraspruzzi personalizzati vengono forniti completi di astine senza kit di fissaggio.
Consigliato per Piaggio Porter, ruota singola e carrello appendice.



PPE black fixing bar for mudflap 200

Astina di fissaggio ppe nero per paraspruzzo 200

ARTICLE	L	H	SP	KG	
AS17TK	170	20	4	0,10	40



Neutral mudflap 250

Paraspruzzo neutro 250

ARTICLE	L	H	P	KG	<u>N.</u>
S25273	250	260	4	0,36	100

i Neutral mudflaps are supplied without fixing bar and screws kit.
I paraspruzzi neutri vengono forniti senza astine e kit di fissaggio.

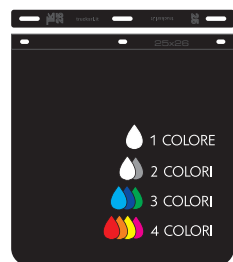

Customized mudflap 250

Paraspruzzo personalizzato 250

ARTICLE	COL	L	H	P	KG	<u>N.</u>
S25274	1	250	260	4	0,38	100
S25275	2	250	260	4	0,38	100
S25276	3	250	260	4	0,38	100
S25277	4	250	260	4	0,38	100

i Customized mudflaps are supplied with fixing bar without screws kit.
I paraspruzzi personalizzati vengono forniti completi di astine senza kit di fissaggio.



PPE black fixing bar for mudflap 250

Astina di fissaggio PPE nero per paraspruzzo 250

ARTICLE	L	H	P	KG	
AS25TK	250	20	4	0,12	40

MUDFLAPS

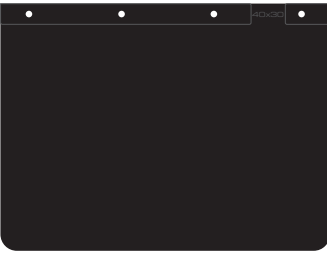

Neutral mudflap 400

Paraspruzzo neutro 400

ARTICLE	L	H	P	KG	N.
S40303	400	300	4	0,57	100

i Neutral mudflaps are supplied without fixing bar and screws kit.
I paraspruzzi neutri vengono forniti senza astine e kit di fissaggio.

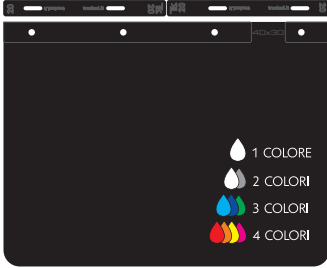

Customized mudflap 400

Paraspruzzo personalizzato 400

ARTICLE	COL	L	H	P	KG	N.
S40304	1	400	300	4	0,59	100
S40355	2	400	300	4	0,59	100
S40356	3	400	300	4	0,59	100
S40357	4	400	300	4	0,59	100

i Customized mudflaps are supplied with fixing bar without screws kit.
I paraspruzzi personalizzati vengono forniti completi di astine senza kit di fissaggio.



PPE black fixing bar for mudflap 400

Astina di fissaggio PPE nero per paraspruzzo 400

ARTICLE	L	H	P	KG	
AS40TK	400	20	4	0,19	40

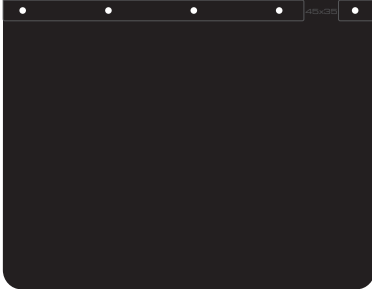

Neutral mudflap 450

Paraspruzzo neutro 450

ARTICLE	L	H	P	KG	N.
S45353	450	350	4	0,83	100

i Neutral mudflaps are supplied without fixing bar and screws kit.
I paraspruzzi neutri vengono forniti senza astine e kit di fissaggio.

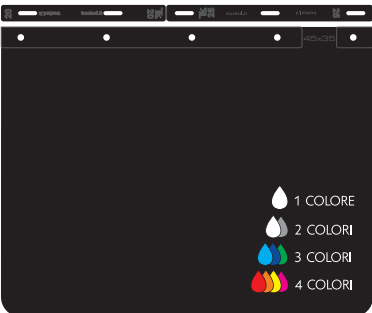

Customized mudflap 450

Paraspruzzo personalizzato 450

ARTICLE	COL	L	H	P	KG	N.
S45354	1	450	300	4	0,59	100
S45355	2	450	300	4	0,59	100
S45356	3	450	300	4	0,59	100
S45357	4	450	300	4	0,59	100

i Customized mudflaps are supplied with fixing bar without screws kit.
I paraspruzzi personalizzati vengono forniti completi di astine senza kit di fissaggio.



PPE black fixing bar for mudflap 450

Astina di fissaggio PPE nero per paraspruzzo 450

ARTICLE	L	H	P	KG	
AS45TK	450	20	4	0,22	40

MUDFLAPS



Neutral mudflap 530

Paraspruzzo neutro 530

ARTICLE	L	H	P	KG	N.
S53373	530	370	4	1,12	100



Customized mudflap 530

Paraspruzzo personalizzato 530

ARTICLE	COL	L	H	P	KG	N.
S53374	1	400	300	4	0,59	100
S53375	2	400	300	4	0,59	100
S53376	3	400	300	4	0,59	100
S53377	4	400	300	4	0,59	100



Customized mudflaps are supplied with fixing bar without screws kit.
I paraspruzzi personalizzati vengono forniti completi di astine senza kit di fissaggio.

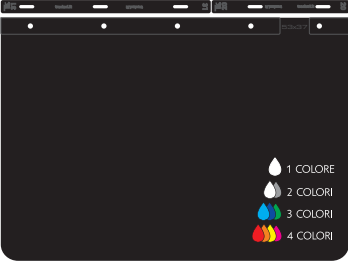

PPE black fixing bar for mudflap 530

Astina di fissaggio PPE nero per paraspruzzo 530

ARTICLE	L	H	P	KG	
AS53TK	530	20	4	0,26	40



Neutral mudflap 650

Paraspruzzo neutro 650

ARTICLE	L	H	SP	KG	
S1720233	650	200	5	0,90	1



Neutral mudflaps are supplied without fixing bar and screws kit.
I paraspruzzi neutri vengono forniti senza astine e kit di fissaggio.

PPE black fixing bar for mudflap 620 *Astina di fissaggio PPE nero per paraspruzzo 620*



ARTICLE	L	H	P	KG	
AS62TK	620	20	4	0,32	40

MUDFLAPS



Neutral mudflap 620

Paraspruzzo neutro 620

ARTICLE	L	H	P	KG	N.
S62403	620	400	4	1,18	100

i Neutral mudflaps are supplied without fixing bar and screws kit.
I paraspruzzi neutri vengono forniti senza astine e kit di fissaggio.

Customized mudflap 620

Paraspruzzo personalizzato 620

ARTICLE	COL	L	H	P	KG	N.
S62404	1	620	400	4	1,21	100
S62405	2	620	400	4	1,21	100
S62406	3	620	400	4	1,21	100
S62407	4	620	400	4	1,21	100

i Customized mudflaps are supplied with fixing bar without screws kit.
I paraspruzzi personalizzati vengono forniti completi di astine senza kit di fissaggio.

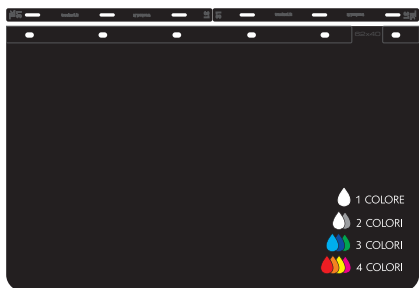



PPE black fixing bar for mudflap 620 *Astina di fissaggio PPE nero per paraspruzzo 620*



ARTICLE	L	H	P	KG	
AS62TK	620	20	4	0,32	40

Calculation of rivets for mounting on mudflaps *Calcolo dei rivetti per il montaggio sui paraspruzzi*

Width Mudflap <i>Larghezza Paraspruzzo</i>	250	400	450	530	620	
Number of Holes <i>Numero dei fori</i>	3	4	5	6	7	
Quantity Mudflaps <i>Quantità Paraspruzzi</i> 20	60	80	100	120	140	
Quantity Mudflaps <i>Quantità Paraspruzzi</i> 50	150	200	250	300	350	3 Confezioni
Quantity Mudflaps <i>Quantità Paraspruzzi</i> 100	300	400	500	600	700	
Quantity Mudflaps <i>Quantità Paraspruzzi</i> 200	600	800	1000	1200	1400	

Black rivet kit *Kit rivetti neri*



ARTICLE	Black Rivet Kit - 4,8x21 T. 14 - pcs 200	KG
RIV4821S	<i>Kit Rivetti Neri - 4,8x21 T. 14 - Pezzi 200</i>	0,79

Black washer kit *Kit rondelle nere*



ARTICLE	Black Washer Kit - 5x20 - pcs 200	KG
R520N	<i>Kit Rondelle Nere - 5x20 - Pezzi 200</i>	0,20

MUDFLAPS

Pair of mudflaps with signals *Coppia paraspruzzi freccia/divieto*

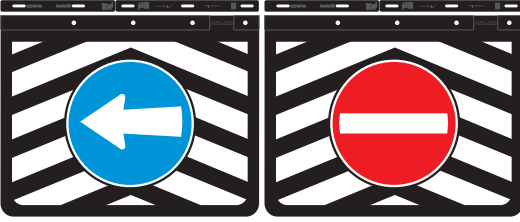

ARTICLE	L	H	SP	KG	KIT
FD4030	400	300	4	1,10	1
FD4535	450	350	4	1,60	1
FD5337	530	370	4	2,40	1
FD6240	620	400	4	2,75	1

i Pair of mudflaps with signals delivered in a single kit with fixing bars and bolts.
Coppia di paraspruzzi freccia/divieto consegnati in kit unico completo di astine e bulloneria.

Long mudflap with signals *Paraspruzzo lungo freccia/divieto*



ARTICLE	L	H	SP	KG	N.
FD2402	2400	350	4	3,80	1



i Long mudflap with signals delivered in a single kit with PVC fixing bars.
Paraspruzzo lungo freccia/divieto consegnato in kit comprensivo di aste PVC di fissaggio.

ARTICLE	L	H	SP	KG	N.
FD2401	2400	350	4	3,80	1

Stainless steel hinge with holes *Cerniera inox con fori*



ARTICLE	L	H	SP	KG	
C400	2500	60	20/10	3,30	1

Galvanized fixing bar for mudflap - old model *Astina di fissaggio - vecchio modello*

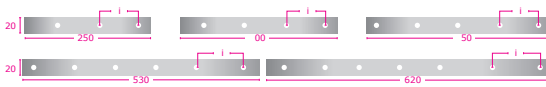

ARTICLE	L	H	i	D	SP	KG	
AS25	250	20	110	8	8/10	0,03	100
AS40	400	20	112	8	8/10	0,04	100
AS45	450	20	102	8	8/10	0,05	100
AS53	530	20	112	8	8/10	0,06	100
AS62	620	20	110	8	8/10	0,07	100

Fixing bar for mudflap *Asta di fissaggio*



ARTICLE	L	H	SP	KG	
AST1	1200	34	1,8	0,210	2

Rivet kit *Kit 2 rivetti*



ARTICLE	D	L	KG	
AS17TK	7,8	18	0,12	1

Screw kit *Kit viti*



ARTICLE		KG
R70124	Screws Kit - 5x20 (7) - 5x0,8 (7) - Flat Screw Ø5 (14) Viti - 5x20 (7) - 5x0,8 (7) - Piana Ø5 (14)	0,05

MUDFLAPS

Long black mudflap *Paraspruzzo nero lungo per traverse*



Neutral mudflap *Neutro*

Customized mudflap *Personalizzato*

Printing Plant *Clichè*

ARTICLE	L	H	SP	KG	N.
S24038	2400	350	4	3,80	1

ARTICLE	COL	L	H	SP	KG	N.
S240381	1	2400	350	4	3,80	10
S240382	2	2400	350	4	3,80	10
S240383	3	2400	350	4	3,80	10
S240384	4	2400	350	4	3,80	10

ARTICLE	Description
C35001	Small clichè <i>Clichè piccolo</i>
C35002	Large clichè <i>Clichè grande</i>
C35003	Graphic processing <i>Elaborazione grafica</i>
C35000	Further Colour <i>Ulteriore colore</i>

i Neutral mudflaps are supplied without fixing bar and screws kit.
I paraspruzzi neutri vengono forniti senza astine e kit di fissaggio.

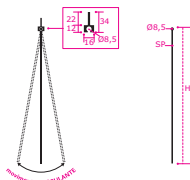

i Customized mudflaps are supplied with fixing bar without screws kit.
I paraspruzzi personalizzati vengono forniti completi di astine senza kit di fissaggio.

Long white mudflap *Paraspruzzo bianco lungo per traverse*

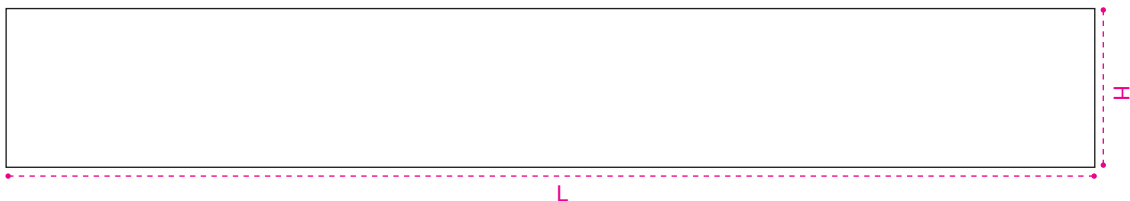

Neutral mudflap *Neutro*

Customized mudflap *Personalizzato*

Printing plant *Clichè*

ARTICLE	L	H	SP	KG	N.
S24038B	2400	350	4	3,80	1

ARTICLE	COL	L	H	SP	KG	N.
S240381B	1	2400	350	4	3,80	10
S240382B	2	2400	350	4	3,80	10
S240383B	3	2400	350	4	3,80	10
S240384B	4	2400	350	4	3,80	10

ARTICLE	Description
C35001	Small clichè <i>Clichè piccolo</i>
C35002	Large clichè <i>Clichè grande</i>
C35003	Graphic processing <i>Elaborazione grafica</i>
C35000	Further Colour <i>Ulteriore colore</i>

i Neutral mudflaps are supplied without fixing bar and screws kit.
I paraspruzzi neutri vengono forniti senza astine e kit di fissaggio.

i Customized mudflaps are supplied with fixing bar without screws kit.
I paraspruzzi personalizzati vengono forniti completi di astine senza kit di fissaggio.

MUDFLAPS

Black shaped mudflap *Paraspruzzo nero sagomato*



Neutral mudflap *Neutro*

Customized mudflap *Personalizzato*

Printing Plant *Clichè*

ARTICLE	L	H	SP	KG	<u>N.</u>	ARTICLE	COL	L	H	SP	KG	<u>N.</u>	ARTICLE	Description
S24031	2400	250	5	4,15	10	S240311	1	2400	250	5	4,15	100	C35001	Small clichè <i>Clichè piccolo</i>
i Neutral mudflaps are supplied without fixing bar and screws kit. I paraspruzzi neutri vengono forniti senza astine e kit di fissaggio.						S240312	2	2400	250	5	4,15	100	C35002	Large clichè <i>Clichè grande</i>
						S240313	3	2400	250	5	4,15	100	C35003	Graphic processing <i>Elaborazione grafica</i>
						S240314	4	2400	250	5	4,15	100	C35000	Further Colour <i>Ulteriore colore</i>

i Customized mudflaps are supplied with fixing bar without screws kit.
 I paraspruzzi personalizzati vengono forniti completi di astine senza kit di fissaggio.

Homologated antispray mudflap - 91/226/EEC Paraspruzzo anti spray omologato - Di r.9 1/226/EEC

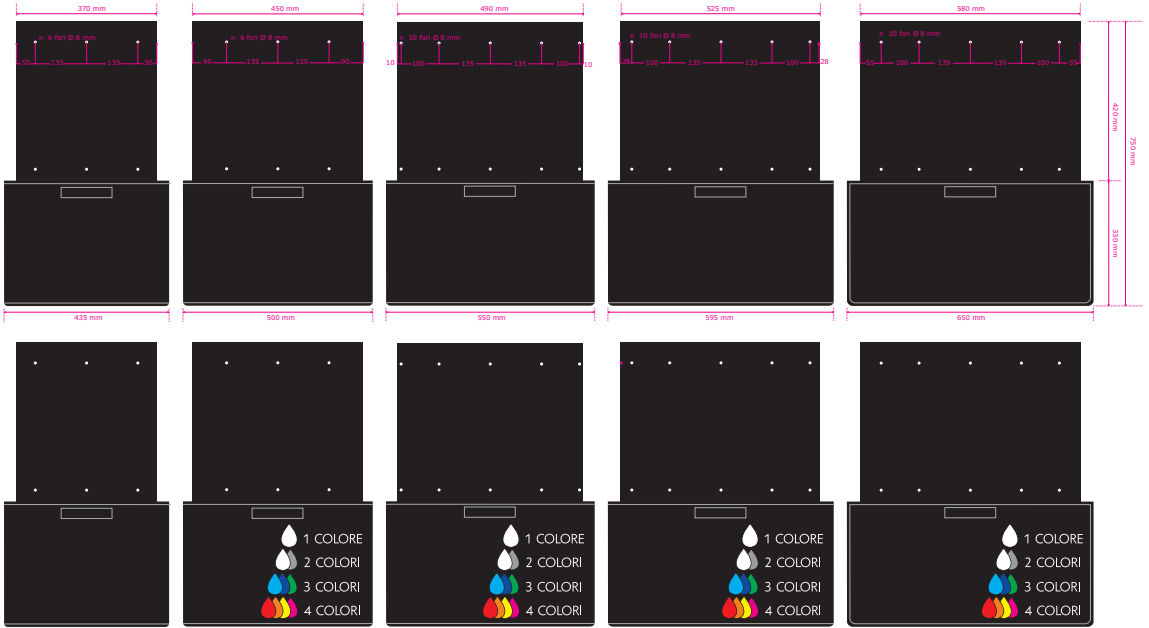

Neutral mudflap *Neutro*

ARTICLE	L	H	i	KG	N.
CPF7543	435	750	20	1,10	2
CPF7550	500	750	20	1,35	2
CPF7555	550	750	20	1,45	2
CPF7560	600	750	20	1,60	2
CPF7565	650	750	20	1,70	2

Mudflap 1 colour *Personalizzato 1 colore*

ARTICLE	L	H	Print Measures Spazio Serigrafia
CPF75431	435	750	41,5x28
CPF75501	500	750	47x28
CPF75551	550	750	52x28
CPF75601	600	750	57x28
CPF75651	650	750	60x28

Mudflap 2 colours *Personalizzato 2 colori*

ARTICLE	L	H	Print Measures Spazio Serigrafia
CPF75432	435	750	41,5x28
CPF75502	500	750	47x28
CPF75552	550	750	52x28
CPF75602	600	750	57x28
CPF75652	650	750	60x28

Mudflap 3 colours *Personalizzato 3 colori*

ARTICLE	L	H	Print Measures Spazio Serigrafia
CPF75433	435	750	41,5x28
CPF75503	500	750	47x28
CPF75553	550	750	52x28
CPF75603	600	750	57x28
CPF75653	650	750	60x28

Printing Plant *Clichè*

ARTICLE	Description
C35001	Small clichè <i>Clichè piccolo</i>
C35002	Large clichè <i>Clichè grande</i>
C35003	Graphic processing <i>Elaborazione grafica</i>
C35000	Further Colour <i>Ulteriore colore</i>

Fitting kit *Kit viti*



ARTICLE	D	L	KG	
R70122	8	25	0,12	1

Rivet kit *Kit 2 rivetti*



ARTICLE	D	L	KG	
R70125	7,8	18	0,12	1

i Homologated antispray mudflap, excellent resistance to atmospheric elements, excellent flexibility for assembly, excellent customised printing space.
Paraspruzzo anti spray omologato, ottima resistenza agli agenti atmosferici, ottima flessibilità per il montaggio, ottimo spazio serigrafabile per la personalizzazione.

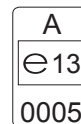

Homologated antispray mudflap - 91/226/EEC

Paraspruzzo antispray omologato - Dir. 91/226/EEC

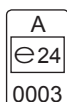
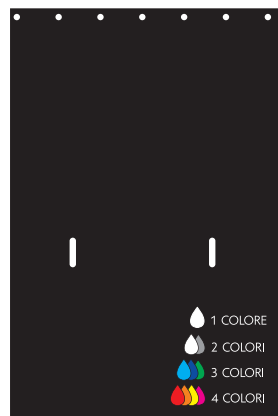
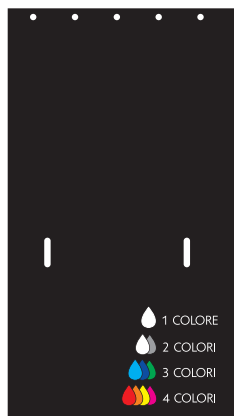
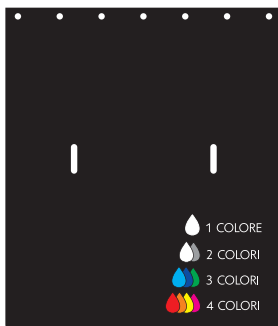
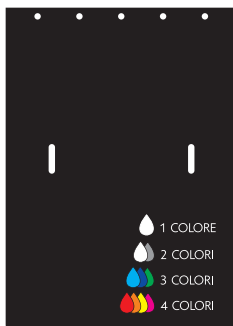

i Homologated antispray mudflap for trailers and semi trailers.
Paraspruzzo antispray omologato per rimorchi e semirimorchi.

Neutral mudflap

Neutro

ARTICLE	L	H	SP	KG	N.
SK5070	500	700	15	3,10	1
SK5090	500	900	15	3,70	1
SK6070	600	700	15	4,50	1
SK6090	600	900	15	4,80	1

Mudflap 1 colour

Personalizzato 1 colore

ARTICLE	L	H	Print Measures Spazio Serigrafia
SK5071	500	700	45x28
SK5091	500	900	45x28
SK6071	600	700	45x28
SK5091	600	900	45x28

Mudflap 2 colours

Personalizzato 2 colori

ARTICLE	L	H	Print Measures Spazio Serigrafia
SK5072	500	700	45x28
SK5092	500	900	45x28
SK6072	600	700	45x28
SK5092	600	900	45x28

Mudflap 3 colours

Personalizzato 3 colori

ARTICLE	L	H	Print Measures Spazio Serigrafia
SK5073	500	700	45x28
SK5093	500	900	45x28
SK6073	600	700	45x28
SK5093	600	900	45x28

Printing Plant

Clichè

ARTICLE	Description
C35001	Small clichè <i>Clichè piccolo</i>
C35002	Large clichè <i>Clichè grande</i>
C35003	Graphic processing <i>Elaborazione grafica</i>
C35000	Further Colour <i>Ulteriore colore</i>

Fixing hook

Gancio di fissaggio



ARTICLE	L	H	KG
SK50001	20	80	0,08



Fixing bar for antispray mudflap

Staffa fissaggio

	ARTICLE	L	H	i	D	SP	KG
for article per cod. SK5070	SK5033	500	330	9,7	10	2	1,30
for article per cod. SK5090	SK5053	500	530	9,7	10	2	1,70
for article per cod. SK6070	SK6033	600	330	9,7	10	2	1,46
for article per cod. SK6090	SK6053	600	530	9,7	10	2	1,80

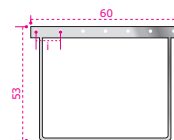
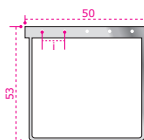
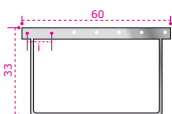
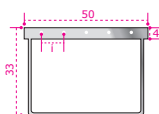

A.D.R. COMPOSITION

Stainless steel signs support for tube holder *Portacartello inox per tubi*



ARTICLE	L	i	D	KG	
T91220	285	205	150	0,70	1
T91221	285	205	200	0,80	1

i Threaded inserts 8x1,25.
Inserti filettati 8x1,25.

Stainless steel collar for tube *Collare con molla inox per portatubi*



ARTICLE	H	D	KG	
T91224	30	150	0,20	100
T91225	30	200	0,22	100

Stainless steel double signs for tube holder *Supporto doppio cartello inox per portatubi*



ARTICLE	L	i	D	KG	
T91222	710	205	150	1,60	1
T91223	710	205	200	1,75	1

i Threaded insert ts 8x1,25.
Inserti filettati 8x1,25.

Stainless steel bar for A.D.R. Signs *Staffa inox per cartelli*



ARTICLE	L	H	i	KG	
T91226	285	50	205	0,38	1

i Threaded inserts 8x1,25.
Inserti filettati 8x1,25.

Stainless steel bar for double A.D.R. Signs *Staffa inox per doppio cartello*



ARTICLE	L	H	i	KG	
T91227	710	50	205	0,76	1

i Threaded inserts 8x1,25.
Inserti filettati 8x1,25.

Stainless steel omega support for signs *Supporto inox ad omega per cartelli*



ARTICLE	L	H	i	KG	
T91069	450	70	205	0,60	1

i Threaded inserts 8x1,25.
Inse ti filettati 8x1,25.

Stainless steel omega support for double signs *Supporto inox doppio ad omega per cartelli*



ARTICLE	L	H	i	KG	
T91077	830	70	205	1,00	1

i Threaded inserts 8x1,25.
Inserti filettati 8x1,25.

Stainless steel Sign holder *Porta cartello inox con molla*



ARTICLE	L	H	i	KG	
T91067	400	300	205	0,80	1
T91071	300	300	205	0,60	1

i Slots 20x10. Asole 20x10.

Aluminum panel for A.D.R. adhesive *Cartello alluminio per adesivi A.D.R.*



ARTICLE	L	H	i	KG	
T91073	300	300	330	0,24	1

i Slots for tourniquet 20x10. On request, special sizes Aluminum/Stainless Steel.
Asole per tourniquet 20x10. Su richiesta misure speciali Alluminio/Acciaio Inox.

A.D.R. COMPOSITION

Own account transport adhesive

Adesivo trasporto conto proprio

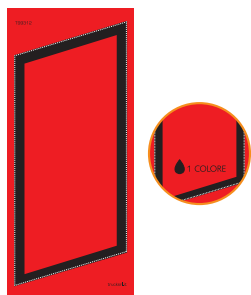

ARTICLE	L	H	KG	
T99311	155	245	0,03	1
T99311P	155	245	0,03	1
T99312	115	240	0,02	1
T99312P	115	240	0,02	1

i Obligatory on all vehicle, positioned anteriorly and posteriorly. Customizable.
E' obbligatorio su tutti i veicoli, posizionamento anteriore e posteriore. Personalizzabile.

Third-party transport adhesive

Adesivo trasporto conto terzi

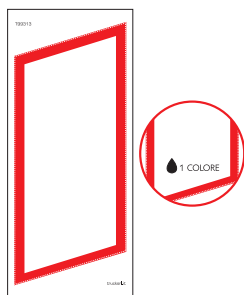

ARTICLE	L	H	KG	
T99310	155	245	0,03	1
T99310P	155	245	0,03	1
T99313	115	240	0,02	1
T99313P	115	240	0,02	1

i Obligatory on all vehicle, positioned anteriorly and posteriorly. Customizable.
E' obbligatorio su tutti i veicoli, posizionamento anteriore e posteriore. Personalizzabile.

Adhesive by-product Cat. 3 animal origin

Adesivo trasporto sottoprodotto origine animale categoria 3



ARTICLE	L	H	KG	
T99633	500	400	0,05	24

Agricultural load transport adhesive

Adesivo trasporto merci agricole



ARTICLE	L	H	KG	
T99619	500	400	0,51	24
T99619P	500	400	0,51	24

Agricultural load transport adhesive

Adesivo trasporto merci agricole



ARTICLE	D	KG	
T99626	380	0,04	24
T99626P	380	0,04	24

Agricultural load transport adhesive

Adesivo trasporto merci agricole



ARTICLE	D	KG	
T99630	380	0,04	24
T99630P	380	0,04	24

Perishable load transport adhesive

Adesivo trasporto prodotti deperibili



ARTICLE	L	H	KG	
T99620	500	400	0,51	24
T99620P	500	400	0,51	24

Perishable load transport adhesive

Adesivo trasporto prodotti deperibili



ARTICLE	D	KG	
T99631	380	0,04	24
T99631P	380	0,04	24

Perishable load transport adhesive

Adesivo trasporto prodotti deperibili



ARTICLE	D	KG	
T99632	380	0,04	24
T996320P	380	0,04	24

Dead corner panel truck adhesive

Adesivo angolo morto per camion



ARTICLE	L	H	KG	
T90601 Rigid Surface <i>Sup. Rigide</i>	170	250	0,12	1
T90603 Tarpaulin Surf. <i>Sup. Telonate</i>	170	250	0,12	1
T90604 Magnetic Surf. <i>Sup. Magnet.</i>	170	250	0,12	1

i Printed on magnet support, on PVC for telonate surfaces, on PVC for rigid surfaces. Stampato su supporto calamitato, per superfici telonate e rigide.

Dead Corner Panel Bus Adhesive

Adesivo angolo morto per Bus



ARTICLE	L	H	KG	
T90602	170	250	0,12	1

i Printed on magnet support, on PVC for telonate surfaces, on PVC for rigid surfaces. Stampato su supporto calamitato, per superfici telonate e rigide.

Waste transport adhesive

Adesivo trasporto rifiuti



ARTICLE	L	H	KG	
T99621	400	400	0,03	1
T99622	150	150	0,01	1

Flammable Liquids Class 2 Transport Adhesive

Adesivo Trasporto Liquidi Infiammabili Classe 2



ARTICLE	L	H	KG	
T99628	300	300	0,02	24

Flammable Liquids Class 3 Transport Adhesive

Adesivo Trasporto Liquidi Infiammabili Classe 3



ARTICLE	L	H	KG	
T99602	300	300	0,02	24
T9960210	100	100	0,01	24

Flammable solids class 4 transport adhesive

Adesivo trasporto solidi infiammabili Classe 4



ARTICLE	L	H	KG	
T99603	300	300	0,02	24

Non inflammable compressed Gas class 2 transport adhesive

Adesivo trasporto gas compresso non infiammabile Classe 2



ARTICLE	L	H	KG	
T99601	300	300	0,02	24

Oxidizing agent and Organic peroxides Transport adhesive

Adesivo trasporto comburenti e perossidi organici



ARTICLE	L	H	KG	
T99625	300	300	0,02	24

Dangerous substances for the environment transport adhesive

Adesivo trasporto materia pericolosa per l'ambiente acquatico



ARTICLE	L	H	KG	
T99639	300	300	0,02	24
T9963910	100	100	0,01	24

A.D.R. COMPOSITION

Corrosive substances
Class 8
transport adhesive
Adesivo trasporto
sostanze corrosive Classe 8



ARTICLE	L	H	KG	
T99614	300	300	0,02	24

General danger
Class 9
Transport adhesive
Adesivo trasporto
pericolosità generica Classe 9



ARTICLE	L	H	KG	
T99615	300	300	0,02	24

Toxic gas
Class 2
Transport adhesive
Adesivo trasporto
gas tossico Classe 2



ARTICLE	L	H	KG	
T99629	300	300	0,02	24

Thermometer
over 20°C
Class 9 adhesive
Adesivo termometro
superiore ai 20°C Classe 9



ARTICLE	L	H	KG	
T99624	300	300	0,02	24

Substances
spontaneous flammable
Adhesive
Adesivo trasporto sostanze
infiammabili spontanee



ARTICLE	L	H	KG	
T99604	300	300	0,02	24

Transport
Explosives Class 1.3
Adhesive
Adesivo trasporto
esplosivi Classe 1.3



ARTICLE	L	H	KG	
T99616	300	300	0,02	24

A.D.R. kit
Kit A.D.R. base

ARTICLE	L	H	P	KG	
KITADR1	500	450	330	8,80	1

- | | | | |
|---------------------------------------------------------------------------------------------------------------------------------------------------------------------------------------------------------------------------------------------------------------------------------------------------------------------------------------------------------------------------------------------------------------------|-------------------------------------------------------------------------------------------------------------------------------------------------------------------------------------------------------------------------------------------------------------------------------------------------------------------------------------------------------------------------------------------------------------------------------------------------------------------------|----------------------------------------------------------------------------------------------------------------------------------------------------------------------------------------------------------------------------------|-----------------------------------------------------------------------------------------------------------------------------------------------------------------------------------------------------------------------------------------------------|
| <ul style="list-style-type: none"> 1 Bag 1 Warning Jacket 1 Torch 2 Emergency Lamp 4 Battery for Emergency Lamp 1 Protective Glass 1 Acid Proof Gloves 1 PVC Boots 1 Eye Rinse Solution 1 Folding Non-Spark Shovel 1 Tyvek Overall® 1 Partial Mask with Filter 1 Filter for Partial Mask | <ul style="list-style-type: none"> 1 Borsa 1 Gilet Fluorescente 1 Lampada Portatile 2 Lampade Crepuscolari 4 Batterie per Lampade Crepuscolari 1 Occhiali Protettivi 1 Guanti Antiacido 1 Stivali in PVC 1 Flacone Lavaggio Oculare 1 Pala Antiscintilla Pieghevole 1 Tuta TYVEK® 1 Maschera Semifacciale 1 Filtro per Maschera Semifacciale | <ul style="list-style-type: none"> 1 PVC Boots 1 Eye Rinse Solution 1 Folding Non-Spark Shovel 1 Tyvek Overall® 1 Partial Mask with Filter 1 Filter for Partial Mask | <ul style="list-style-type: none"> 1 Stivali in PVC 1 Flacone Lavaggio Oculare 1 Pala Antiscintilla Pieghevole 1 Tuta TYVEK® 1 Maschera Semifacciale 1 Filtro per Maschera Semifacciale |
|---------------------------------------------------------------------------------------------------------------------------------------------------------------------------------------------------------------------------------------------------------------------------------------------------------------------------------------------------------------------------------------------------------------------|-------------------------------------------------------------------------------------------------------------------------------------------------------------------------------------------------------------------------------------------------------------------------------------------------------------------------------------------------------------------------------------------------------------------------------------------------------------------------|----------------------------------------------------------------------------------------------------------------------------------------------------------------------------------------------------------------------------------|-----------------------------------------------------------------------------------------------------------------------------------------------------------------------------------------------------------------------------------------------------|



TRUCK
Design

Montepulciano Stazione (SI)
ITALY - Tel. +39 0578 708 709

www.tkdesign.it - export@trucksrl.it