

021

last version catalogue

Y |

O

U

R

T

TRUCK



evolution

of ideas

TRUCK S.R.L. - CATALOGUE LAST VERSION

*Updates:*

- November 2017 -
- July 2018 -
- October 2019 -
- November 2021 -

<b>01</b>	<b>Toolboxes, Brackets and Accessories</b>	<b>6 - 22</b>
	<i>Cassette, Staffe e Accessori</i>	
<b>02</b>	<b>Documents Holder</b>	<b>23 - 25</b>
	<i>Portadocumenti</i>	
<b>03</b>	<b>Mudguards and Supports</b>	<b>26 - 54</b>
	<i>Parafanghi e Supporti</i>	
<b>04</b>	<b>Wheel Chocks</b>	<b>55</b>
	<i>Calzatoie</i>	
<b>05</b>	<b>Fireboxes</b>	<b>56 - 58</b>
	<i>Portaestintori</i>	
<b>06</b>	<b>Water Tanks and Accessories</b>	<b>59 - 78</b>
	<i>Taniche Acqua e Accessori</i>	
<b>07</b>	<b>Mudflaps</b>	<b>79 - 85</b>
	<i>Paraspruzzi</i>	
<b>08</b>	<b>Bumper Bars and Accessories</b>	<b>86 - 92</b>
	<i>Paraincastri, Portafanali e Accessori</i>	
<b>09</b>	<b>Universal License Plates Holder</b>	<b>93 - 94</b>
	<i>Portatarghe Universali</i>	
<b>10</b>	<b>Protective Grills</b>	<b>95</b>
	<i>Griglie Parasassi</i>	
<b>11</b>	<b>Ladders</b>	<b>96 - 98</b>
	<i>Scalette</i>	
<b>12</b>	<b>Body Mounting Brackets</b>	<b>99 - 100</b>
	<i>Supporti Falso Telaio</i>	
<b>13</b>	<b>Winches and Hooks</b>	<b>101 - 102</b>
	<i>Verricelli e Ganci</i>	
<b>14</b>	<b>Hinges</b>	<b>103 - 107</b>
	<i>Cerniere</i>	
<b>15</b>	<b>Accessories for Tipper</b>	<b>108 - 110</b>
	<i>Accessori Ribaltabili</i>	
<b>16</b>	<b>Hinges and Latches</b>	<b>111 - 112</b>
	<i>Cerniere e Chiusure</i>	
<b>17</b>	<b>Accessories</b>	<b>113</b>
	<i>Accessori Vari</i>	
<b>18</b>	<b>Rubber Buffers</b>	<b>114 - 116</b>
	<i>Tamponi Paracolpi</i>	
<b>19</b>	<b>Wheel Carrier</b>	<b>117</b>
	<i>Portaruota</i>	
<b>20</b>	<b>Sideguards and Profiles</b>	<b>118 - 121</b>
	<i>Paracicli e Profili</i>	
<b>21</b>	<b>Dropside Lock and Pillars</b>	<b>122 - 135</b>
	<i>Piantoni e Montanti</i>	
<b>22</b>	<b>Anti-Theft Fuel Caps</b>	<b>136</b>
	<i>Antifurto Serbatoi</i>	
<b>23</b>	<b>Load Bars and Accessories for Tarpaulins</b>	<b>137 - 141</b>
	<i>Fermacarico e Accessori Teloni</i>	
<b>24</b>	<b>Spoiler</b>	<b>142 - 145</b>
	<i>Spoiler</i>	
<b>25</b>	<b>Sealants</b>	<b>146 - 147</b>
	<i>Sigillanti</i>	
<b>26</b>	<b>Electrical Equipments</b>	<b>148 - 159</b>
	<i>Materiale Elettrico</i>	
<b>27</b>	<b>Reflecting Tapes</b>	<b>160 - 161</b>
	<i>Nastri Riflettenti</i>	
<b>28</b>	<b>Panels, Speed Limit and PVC Adhesives</b>	<b>162 - 163</b>
	<i>Pannelli, Dischi Limite e Adesivi in PVC</i>	
<b>29</b>	<b>Signposting and ADR</b>	<b>164 - 170</b>
	<i>Segnaletica e ADR</i>	

# catalogue index

# Toolboxes



## Toolbox Made By Injection

*Cassetta Termoplastica ad Iniezione*

ARTICLE	L	H	P	KG	
C80001	500	350	430	3,60	50

**P** Printable space for customization Spazio serigrafabile

C80001P	372x80
H6000	Cliché for print Cliché per stampa

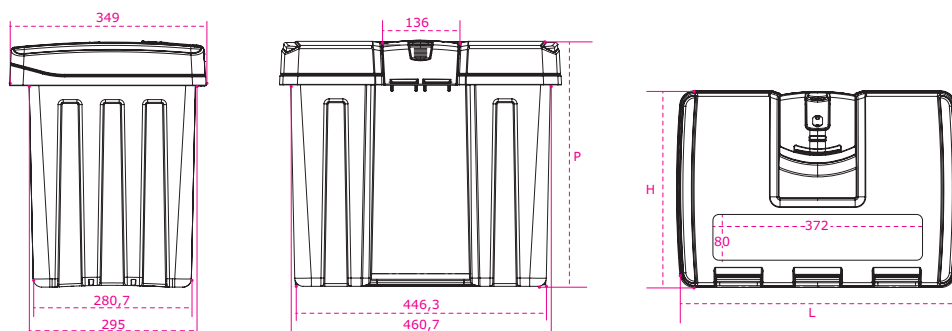

**i** Toolbox made by injection using polypropylene, a high quality material that guarantees good resistance to shocks and high and low temperatures. Anti-vibration handle: this innovative lid system consists of an anti-vibration handle with a double locking mechanism equipped with a key and lid lock. It's possible to customize this product with your logo on the toolbox by a silk-screen process.

*Cassetta porta attrezzi realizzata per iniezione utilizzando polipropilene, un materiale ad alta qualità che garantisce grande resistenza ad urti e ad alte e basse temperature. Maniglia antivibrazione: l'innovativo sistema di chiusura è costituito da una maniglia antivibrazione con doppio meccanismo di bloccaggio e dotata di chiave e cappuccio copritoppa. È possibile personalizzare questo prodotto aggiungendo il Vostro logo sul coperchio tramite serigrafia.*

## Universal Black Painted Steel Bracket

*Coppia Staffe Universali Acciaio Verniciato Nero*

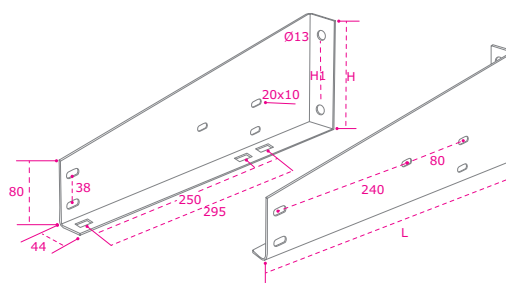

ARTICLE	L	H	H1	SP	KG	
S60000	455	155	105	30/10	3,60	2



## Thermoplastic One Handle Toolbox Made by Injection

Cassetta Termoplastica ad Iniezione Una Maniglia



ARTICLE	L	H	P	KG	
C70003	500	350	300	2,90	40
C70004	500	350	400	3,32	40
C70001	600	400	470	4,70	30
C70006	650	530	500	7,30	20
C70002	800	480	480	7,50	20

In compliance with the legislation ECE R73.01 lateral protection devices.  
Conforme alla Normativa ECE R73.01 dispositivi di protezione laterale.

**P** Printable space for customization Spazio serigrafabile

C70003P - C70004P	210x40
C70001P - C70006P	240x50
H6000	Cliché for print Cliché per stampa

**i** Thermoplastic toolbox with a key, made by injection, central handle, resistant to shocks and temperatures, watertight lid, possibility to customize.  
Cassetta con chiave, termoplastico ad iniezione, maniglia centrale, particolare resistenza agli urti e temperature, chiusura stagna, possibilità di personalizzazione.

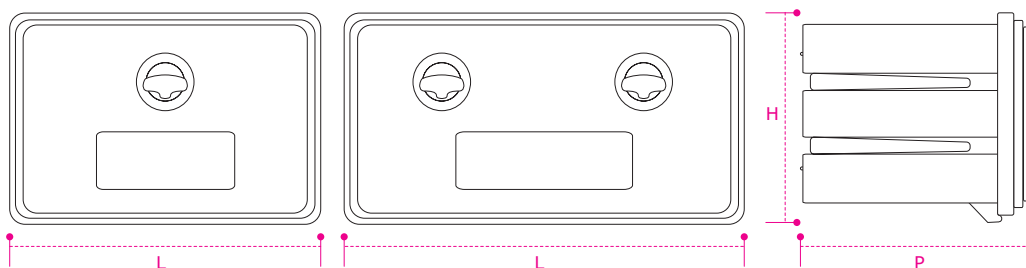

## Thermoplastic Two Handle Toolbox Made by Injection

Cassetta Termoplastica ad Iniezione Due Maniglie



ARTICLE	L	H	P	KG	
C70005	1000	500	500	7,90	20

In compliance with the legislation ECE R73.01 lateral protection devices.  
Conforme alla Normativa ECE R73.01 dispositivi di protezione laterale.

**P** Printable space for customization Spazio serigrafabile

C70005P	240x50
H6000	Cliché for print Cliché per stampa



# Toolboxes



## Thermoplastic One Handle Toolbox Made by a Rotomolding System

Cassetta Termoplastica Rotazionale Una Maniglia



ARTICLE	L	H	P	KG	
C60001	400	350	370	4,00	42
C60005	500	300	450	6,00	24
C60002	500	400	370	6,00	24
C60003	600	400	470	6,90	20
C60004	600	450	470	7,00	8
C60012	700	350	350	6,30	8
C60011	700	500	600	10,50	8
C60006	800	400	500	11,00	8
C60024	800	500	500	11,50	8

In compliance with the legislation ECE R73.01 lateral protection devices.  
Conforme alla Normativa ECE R73.01 dispositivi di protezione laterale.

**P** Printable space for customization Spazio serigrafabile

C60001P-C60005P-C60002P 210x40

C60003P-C60024P 240x50

H6000 Cliché for print Clichè per stampa

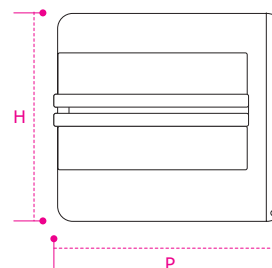
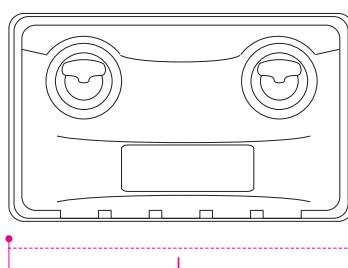
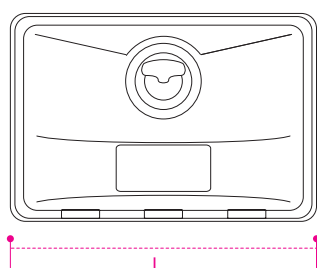

**i** Thermoplastic toolbox made by a rotomolding system with one or two handles with a special key, resistant and strong, thick and weighty, long lasting, possible to customize.  
Cassetta Termoplastica rotazionale una o due maniglie con chiave, particolare resistenza e robustezza, grandi spessori e peso, permettono una lunga durata nel tempo, possibilità di personalizzazione.

## Thermoplastic Two Handles Toolbox Made by a Rotomolding System

Cassetta Termoplastica Rotazionale Due Maniglie



ARTICLE	L	H	P	KG	
C60007	1000	500	500	12,80	8
C60010	1000	400	500	12,10	8
C60008	1200	400	500	13,10	8
C60009	1200	480	500	14,60	8

In compliance with the legislation ECE R73.01 lateral protection devices.  
Conforme alla Normativa ECE R73.01 dispositivi di protezione laterale.

**P** Printable space for customization Spazio serigrafabile

C60007P-C60010P 240x50

H6000 Cliché for print Clichè per stampa



## Thermoplastic One Handle Toolbox Made by a Rotomolding System

*Cassetta Termoplastica Rotazionale Una Maniglia*



ARTICLE	L	H	P	KG	
<b>C60026</b>	500	260	260	3,00	1

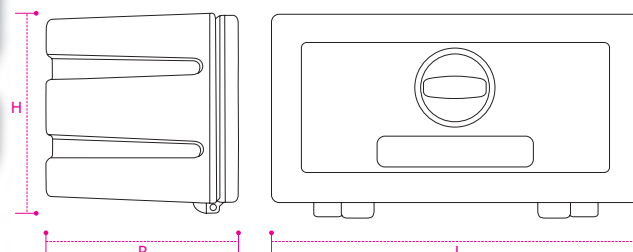

**i** Thermoplastic toolbox made by a rotomolding system, one handle with a special key, resistant and strong, thick and weighty, long lasting, possible to customize. Particularly recommended for vans as it is flexible with a depth of 260 mm.

*Cassetta Termoplastica rotazionale una maniglia con chiave, particolare resistenza e robustezza, grandi spessori e peso, permettono una lunga durata nel tempo, possibilità di personalizzazione. Particolarmente indicata perchè molto flessibile per i mezzi furgonati avendo una profondità di 260 mm.*

**P** Printable space for customization Spazio serigrafabile

<b>C60026P</b>	240x50
<b>H6000</b>	Cliché for print Cliché per stampa



## Thermoplastic Toolbox Made by Injection

*Cassetta Termoplastica Economica*

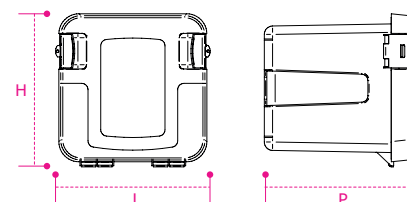

ARTICLE	L	H	P	KG	
<b>C60025</b>	350	350	350	2,18	30

**P** **C60025P** 350 350 350 2,18 30

**H6000** Cliché for print Cliché per stampa

In compliance with the legislation ECE R73.01 lateral protection devices.  
*Conforme alla Normativa ECE R73.01 dispositivi di protezione laterale.*

# Toolboxes



## Thermoplastic Toolbox

Cassetta Termoplastica chiusura a Cassapanca



ARTICLE	L	L1	H	P	KG	
C90001	630	490	350	290	2,46	1

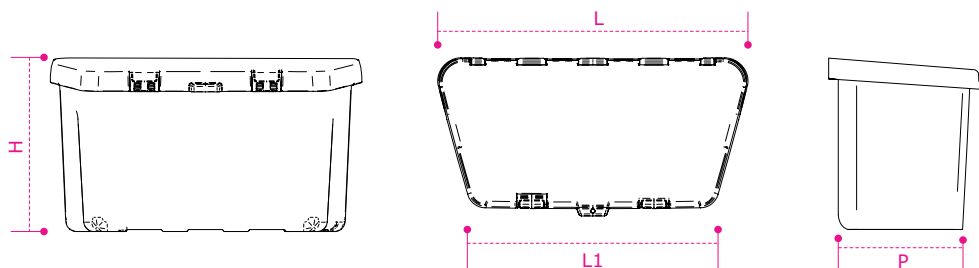

**i** Innovative Thermoplastic Toolbox made by injection with a honeycomb reinforced double lid and a holed lath for a padlock. The wedge shape provides a rudder fixture for a trailer and agricultural trailers; the back fixture has 4 PVC spacers for better attaching on the dropside with an easier lid opening. The spacer kit is not included with the toolbox.

*Innovativa Cassetta Termoplastica ad Iniezione con coperchio a cassapanca rinforzato a nido d'ape con doppia chiusura e listello forato con predisposizione lucchetto. La forma estetica a cuneo prevede il fissaggio a timone prettamente su rimorchi appendice o rimorchi agricoli; il fissaggio sulla parte posteriore dispone in alternativa di 4 distanziali in pvc che permettono un miglior attacco alla sponda con un'apertura più agevole del coperchio. Il Kit Distanziali non viene fornito con la cassetta.*

## 4 Spacer Kit

Kit 4 distanziali



ARTICLE	D	D1	D2	H	KG	
C90002	30	29	8,5	28	0,03	1

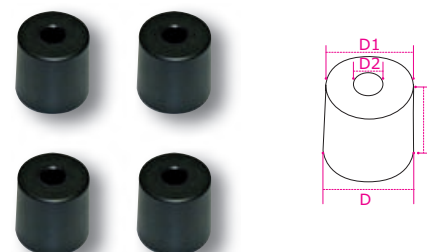

# Pallet Boxes



## Closed Galvanized Steel Pallet Box

Porta Pallets Chiuso Acciaio Zincato

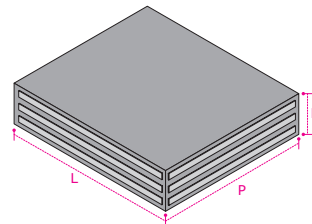
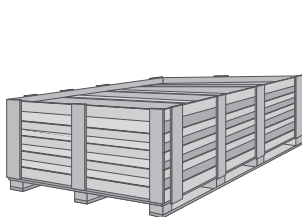

ARTICLE	L	H	P	SP	
C20080C	2740	650	2480	15/10	36
C20082C	2740	610	2480	15/10	30
C20084C	2740	500	2480	15/10	24
C20085C	3275	610	2480	15/10	36
C20092C	3500	500	2480	15/10	32

**i** Galvanized steel pallet box, 2480mm in depth it's particularly recommended for semi-trailers, supplied disassembled and boxed. Special sizes on request. For 'CLOSED' model it's possible to request a mounted product, price for assembly and transport on request.

Porta pallet in acciaio zincato profondità 2420 particolarmente indicato per semirimorchi fornito smontato e scatolato. Su richiesta misure speciali. Per il modello "CHIUSO" è possibile richiedere il prodotto montato, prezzo montaggio e trasporto da preventivare.

## Open Galvanized Steel Pallet Box

Porta Pallets Aperto Acciaio Zincato

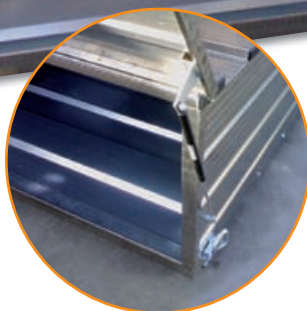
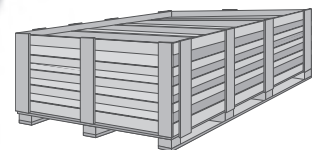
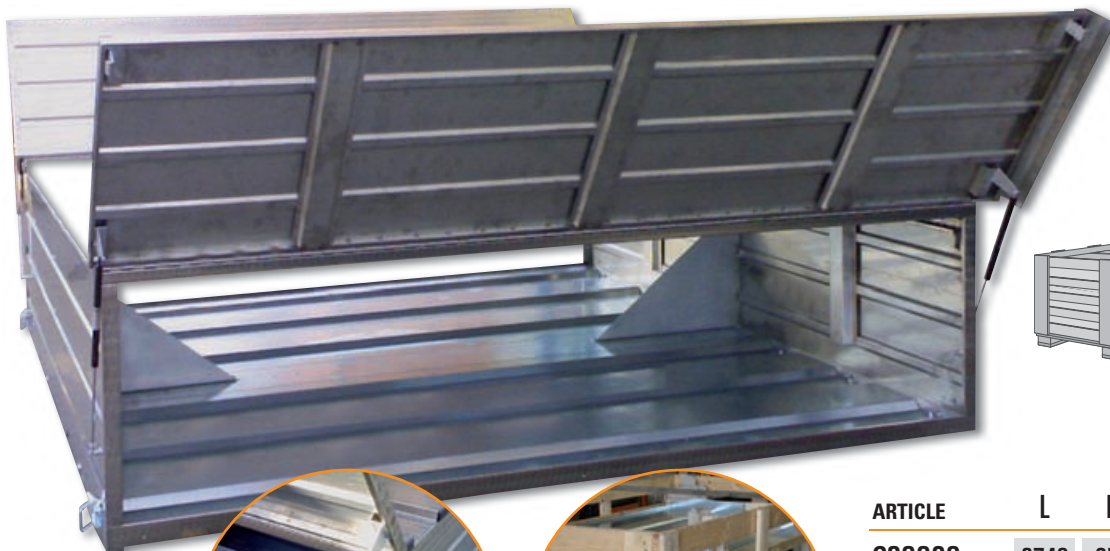

ARTICLE	L	H	P	SP	
C20080	2740	650	2480	15/10	36
C20082	2740	610	2480	15/10	30
C20084	2740	500	2480	15/10	24
C20085	3275	610	2480	15/10	36
C20092	3500	500	2480	15/10	32

# Toolboxes



## One Handle Black Painted Steel Toolbox

*Cassetta Europa Acciaio Verniciato Nero Una Maniglia*



ARTICLE	L	H	P	SP	KG	◆
<b>C30003</b>	400	300	300	15/10	9,50	45
<b>C30007</b>	500	300	400	15/10	13	42
<b>C30009</b>	500	400	500	15/10	17,5	24
<b>C30013</b>	600	400	500	15/10	20,5	20

In compliance with the legislation ECE R73.01 lateral protection devices.  
 Conforme alla Normativa ECE R73.01 dispositivi di protezione laterale.

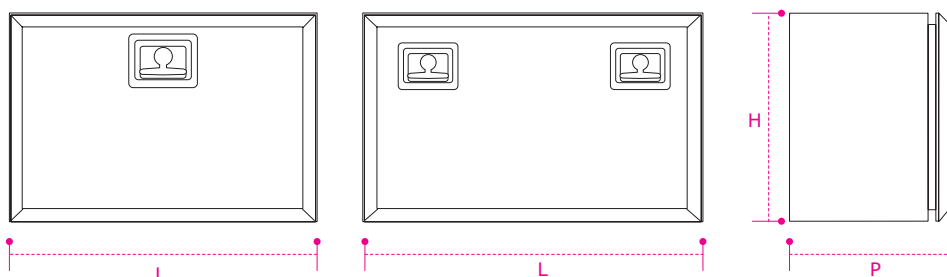

**i** Black painted steel toolbox "Europa" model, entirely welded, 15/10 thick, blunt lid with welded corners, polypropylene lid and hinges.

Special sizes on request in 10/10 – 12/10 thick.

*Cassetta modello Europa in acciaio verniciato Nero, interamente saldata, spessori 15/10, coperchio smussato con angoli saldati, chiusura e cerniere in polipropilene. Su richiesta misure speciali e spessori 10/10 - 12/10.*

## Two Handle Black Painted Steel Toolbox

*Cassetta Europa Acciaio Verniciato Nero Due Maniglie*



ARTICLE	L	H	P	SP	KG	◆
<b>C30016</b>	800	500	500	15/10	26	8
<b>C30020</b>	1000	500	500	15/10	30,8	6

In compliance with the legislation ECE R73.01 lateral protection devices.  
 Conforme alla Normativa ECE R73.01 dispositivi di protezione laterale.



## One Handle Flowered Stainless Steel Toolbox

*Cassetta Europa Inox Fiorettata Una Maniglia*



ARTICLE	L	H	P	SP	KG	
<b>C40003</b>	400	300	300	15/10	9,50	45
<b>C40007</b>	500	300	400	15/10	13,0	42
<b>C40009</b>	500	400	500	15/10	17,5	24
<b>C40013</b>	600	400	500	15/10	20,5	20

In compliance with the legislation ECE R73.01 lateral protection devices.  
 Conforme alla Normativa ECE R73.01 dispositivi di protezione laterale.

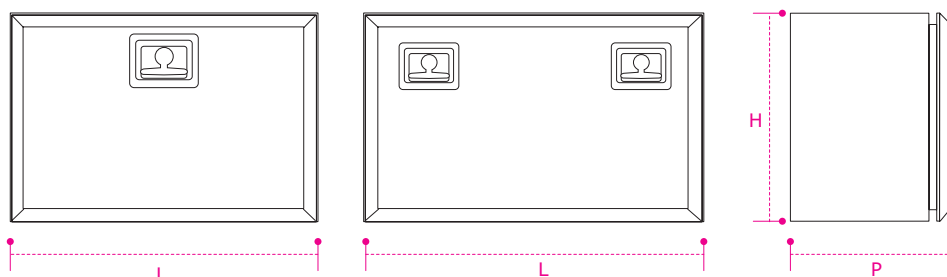

**i** Flowered stainless steel toolbox "Europa", entirely welded, 15/10 thick, blunt lid with welded corners, polypropylene lid and hinges.  
 Special sizes on request and 10/10 – 12/10 thick.  
 Cassetta modello Europa in acciaio inox fiorettato, interamente saldata, spessori 15/10, coperchio smussato con angoli saldati, chiusura e cerniere in polipropilene. Su richiesta misure speciali e spessori 10/10 - 12/10.

## Two Handle Flowered Stainless Steel Toolbox

*Cassetta Europa Inox Fiorettata Due Maniglie*



ARTICLE	L	H	P	SP	KG	
<b>C40016</b>	800	500	500	15/10	26	8
<b>C40020</b>	1000	500	500	15/10	30,8	6

In compliance with the legislation ECE R73.01 lateral protection devices.  
 Conforme alla Normativa ECE R73.01 dispositivi di protezione laterale.

# Toolboxes



## One Handle Galvanized Steel Toolbox

*Cassetta Zincata Standard Una Maniglia*



ARTICLE	L	H	P	SP	KG	
C10001	300	300	300	8/10	4,30	50
C10002	350	350	350	8/10	4,90	50
C10025	400	300	185	8/10	3,50	50
C10003	400	300	300	8/10	4,90	45
C10026	400	300	470	8/10	6,20	50
C10006	500	300	300	8/10	5,70	42
C10007	500	300	400	8/10	6,70	42
C10009	500	400	500	8/10	9,00	24
C10010	600	300	300	8/10	6,40	24
C10011	600	300	400	8/10	6,60	20
C10012	600	400	400	8/10	8,90	20
C10013	600	400	500	8/10	9,50	20

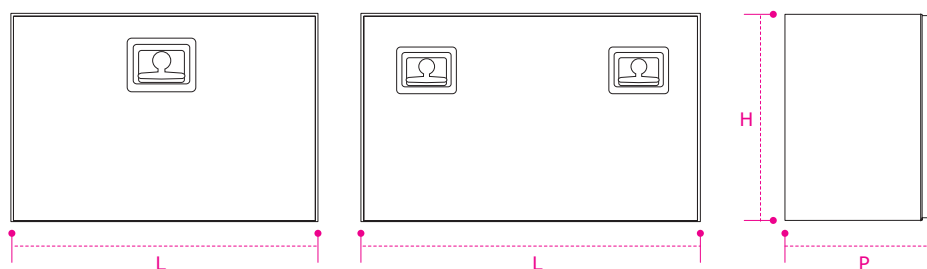

**i** Galvanized steel toolbox with PVC cover, covered welded corners, steel hinges. Special sizes on request.  
*Cassetta in Acciaio Zincato modello standard chiusura in pvc, angoli coperchio saldati, cerniere in acciaio. Su richiesta misure speciali.*

## Two Handles Galvanized Steel Toolbox

*Cassetta Zincata Standard Due Maniglie*



ARTICLE	L	H	P	SP	KG	
C10015	800	400	400	8/10	11,40	15
C10016	800	500	500	8/10	13,70	8
C10017	800	500	600	8/10	16,30	8
C10018	800	600	500	8/10	16,30	8
C10019	800	600	600	8/10	18,20	6
C10029	1000	400	400	8/10	16,10	6
C10020	1000	500	500	8/10	17,30	6
C10021	1000	500	600	8/10	19,80	6
C10022	1000	600	500	8/10	19,80	3
C10028	1200	500	500	8/10	19,50	3
C10024	1200	600	600	8/10	24,60	3



## One Handle Flowered Stainless Steel Toolbox

*Cassetta Inox Fiorettato Standard Una Maniglia*



ARTICLE	L	H	P	SP	KG	
C20001	300	300	300	8/10	4,30	50
C20002	350	350	350	8/10	5,40	50
C20003	400	300	300	8/10	4,90	45
C20025	400	300	470	8/10	6,20	20
C20006	500	300	300	8/10	5,07	42
C20007	500	300	400	8/10	6,70	42
C20009	500	400	500	8/10	9,10	24
C20010	600	300	300	8/10	6,70	24
C20011	600	300	400	8/10	7,80	20
C20012	600	400	400	8/10	9,10	20
C20013	600	400	500	8/10	10,50	20

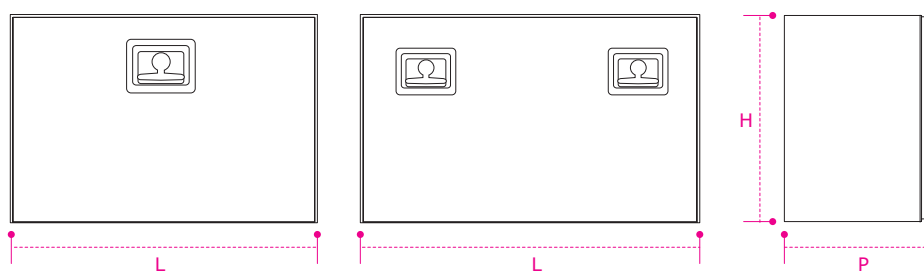

**i** Flowered stainless steel toolbox with PVC cover, welded corners, steel hinges. Special sizes on request.  
*Cassetta in Acciaio Inox Fiorettato modello standard chiusura in pvc, angoli coperchio saldati, cerniere in acciaio. Su richiesta misure speciali.*

## Two Handles Flowered Stainless Steel

*Cassetta Inox Fiorettato Standard Due Maniglie*



ARTICLE	L	H	P	SP	KG	
C20015	800	400	400	8/10	11,4	15
C20016	800	500	500	8/10	14,5	8
C20017	800	500	600	8/10	16,3	8
C20018	800	600	500	8/10	16,3	8
C20019	800	600	600	8/10	18,2	6
C20020	1000	500	500	8/10	17,3	6
C20021	1000	500	600	8/10	19,8	6
C20022	1000	600	500	8/10	19,8	3
C20024	1200	600	600	8/10	24,6	3



# Special Toolboxes

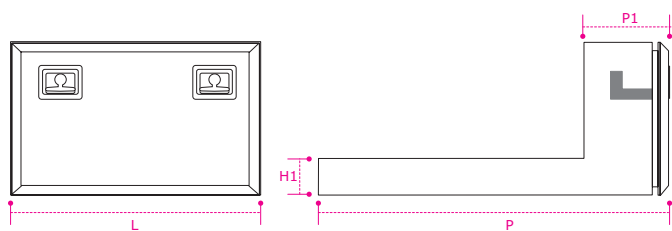

## Stainless Steel Transpallet Box

Porta Transpallet

ARTICLE		L	H	P	P1	H1	SP	KG	
K30010	Flowered Fiore	820	650	1600	380	150	15/10	64,50	2
K30012	Black Nero	820	650	1600	380	150	15/10	64,50	2

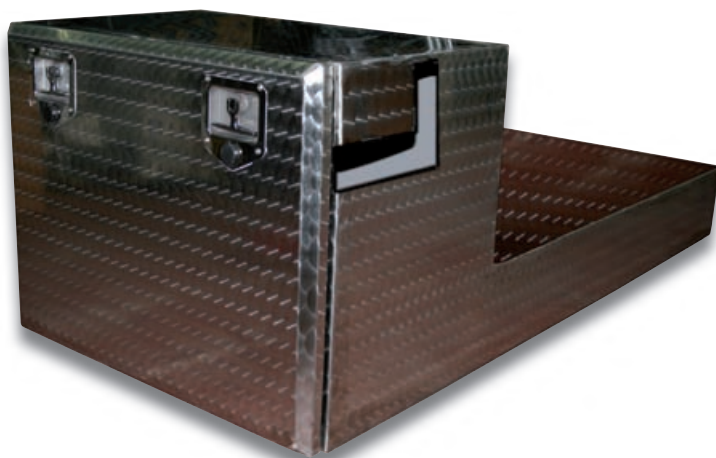

**i** Black painted or flowered stainless steel transpallet box, EUROPA cover, stainless steel or PVC handles. Sizes and different thicknesses on request. Porta transpallet acciaio verniciato nero o inox fiorettato, coperchio EUROPA, maniglie inox o PVC. Su richiesta possibilità di misure e spessori diversi.

## Standard Galvanized Steel Toolbox with Two Handles and Water Tank 10 Lt.

Cassetta Zincata Standard Due Maniglie con Tanica Acqua da 10 Lt.

ARTICLE	L	H	P	SP	KG	
<b>P</b> C10027	800	400	400	8/10	6,50	1

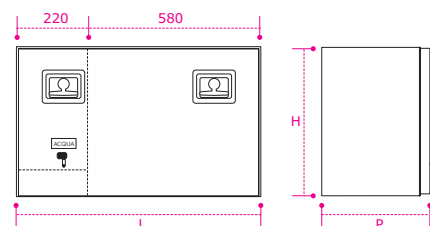

**i** Galvanized toolbox 8/10 with two handles, tap fixture on the left side of the lid, internal divider for PVC water tank 10lt. With dripless cap for fixing to the tap by a rilsan tube and a revolving junction that avoids the deployment of a tube, internal space available 580x400mm, in addition a small compartment under the water tank.

Cassetta Zincata 8/10 doppia maniglia, con rubinetto acqua fissato sulla parte sx del coperchio, divisorio interno per tanica pvc 10 lt. con tappo antigoccia e fissaggio al rubinetto tramite tubo rilsan e raccordi girevoli che ne evitano il dispiegamento, spazio disponibile interno 580x400 mm., oltre ad un piccolo comparto portaoggetti posizionato sotto la tanica.

# Special Toolboxes



## Tailored Toolbox Chest with One Handles

*Cassetta Modello Cassapanca con Una Chiusura*

ARTICLE	L	H	P	SP	KG	
C18C402030	400	200	300	8/10	3,50	1
C18C403060	400	300	600	8/10	6,60	1
C18C504060	500	400	600	8/10	9,50	1
C18C603030	600	300	300	8/10	6,40	1

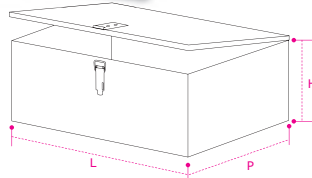

## Tailored Toolbox Chest with Two Handles

*Cassetta Modello Cassapanca con Due Chiusure*

ARTICLE	L	H	P	SP	KG	
C18C703050	700	300	500	8/10	11,40	1
C18C805040	800	500	400	8/10	12,30	1
C18C1104040	1100	400	400	8/10	16,50	1

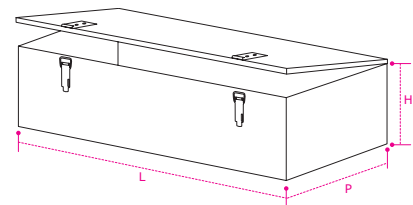

## Tailored Toolbox Chest with Three Handles

*Cassetta Modello Cassapanca con Tre Chiusure*

ARTICLE	L	H	P	SP	KG	
C15C1106040	1100	600	400	15/10	30,80	1
C15C1504040	1500	400	400	15/10	39,50	1
C15C1955050	1950	500	500	15/10	62,50	1

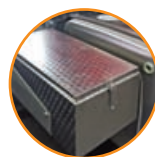
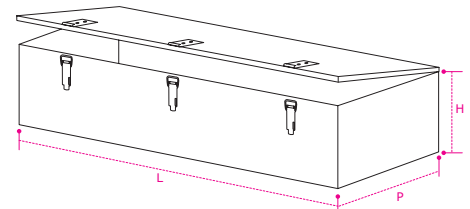

## Tailored Toolbox Scania Chest with Lid

*Cassetta Modello Scania a Cassapanca*

*Acciaio Inox Fioretato con Coperchio Estraibile*

ARTICLE	L	H	P	SP	KG	
C28C352560	350	250	600	8/10	6,00	1

Recommended for Scania New Generation Tractor.  
Raccomandata per Trattore Scania New Generation.

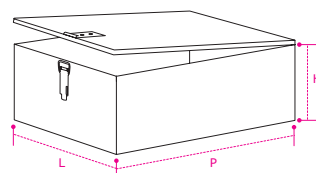

Toolbox made on a drawing with customized measures and model. You can download the request form on our website, in the "Download" area and choosing the "Tailored Toolboxes" link.

Cassetta realizzata a disegno con misure e modello personalizzato. Disponibile il modulo di richiesta sul nostro sito Internet, in area "Download", scegliendo il link "Cassette Su Misura".

# Special Toolboxes



## Flowered Stainless Steel Toolbox with Aluminium Shutter

*Cassetta Inox Fiorettato con Serrandina in Alluminio a Tenuta Stagna*

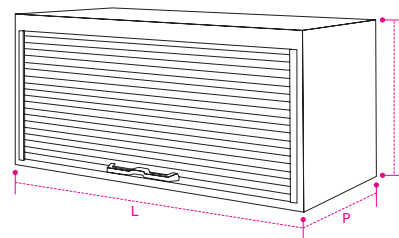

Flowered stainless steel toolbox with watertight aluminium shutter, HIGH QUALITY, recommended for rescue vehicles, fire fighters and special outfits. In the version without the shutter, the height measurement must be less than the depth measurement to give space to the overall opening of the cover that slides on rails to the top of the depth. Raw steel, galvanized and in various thicknesses on request.

*Cassetta inox fiore con chiusura a serrandina in alluminio a tenuta stagna, ALTA QUALITÀ, prodotto consigliato per mezzi di soccorso, vigili del fuoco, allestimenti speciali. Nella versione senza avvolgitore la misura H deve essere inferiore alla misura P per dare spazio alla totale apertura del coperchio che scorre mediante rotaia nella parte superiore della profondità. Su richiesta acciaio grezzo, zincato e vari spessori.*

## Tailored Toolbox Double Door with Central Upright

*Cassetta Modello Doppia Anta con Piantone Centrale*

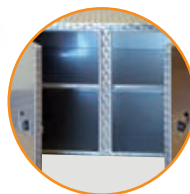
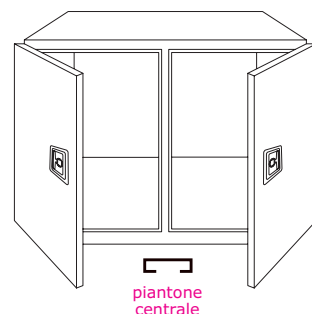
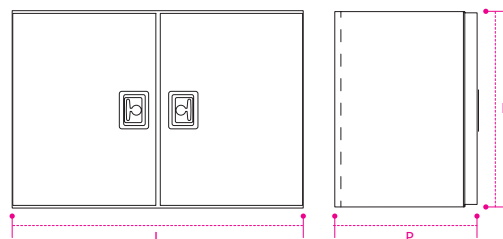
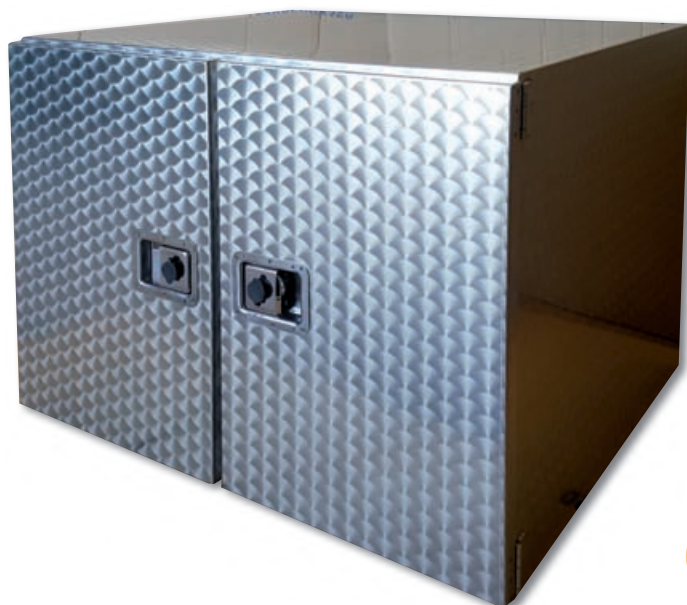

Toolbox made on a drawing with customized measures and model. You can download the request form on our website, in the "Download" area and choosing the "Tailored Toolboxes" link.

*Cassetta realizzata a disegno con misure e modello personalizzato. Disponibile il modulo di richiesta sul nostro sito Internet, in area "Download", scegliendo il link "Cassette Su Misura".*



## Tailored Toolbox Bilateral Double Opening

*Cassetta Bilaterale Doppio Sportello*

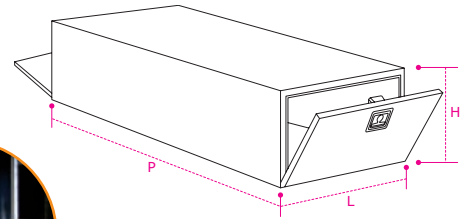

**i** Toolbox made on a drawing with customized measures and model. You can download the request form on our website, in the **"Download"** area and choosing the **"Tailored Toolboxes"** link.

*Cassetta realizzata a disegno con misure e modello personalizzato. Disponibile il modulo di richiesta sul nostro sito Internet, in area "Download", scegliendo il link "Cassette Su Misura".*

## Tailored Toolbox

*Cassetta su Misura con Scasso Posteriore*

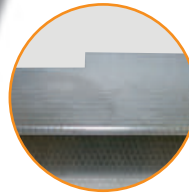
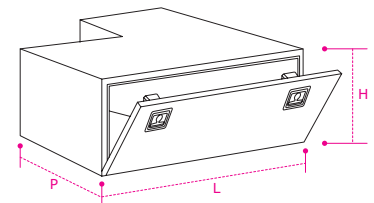
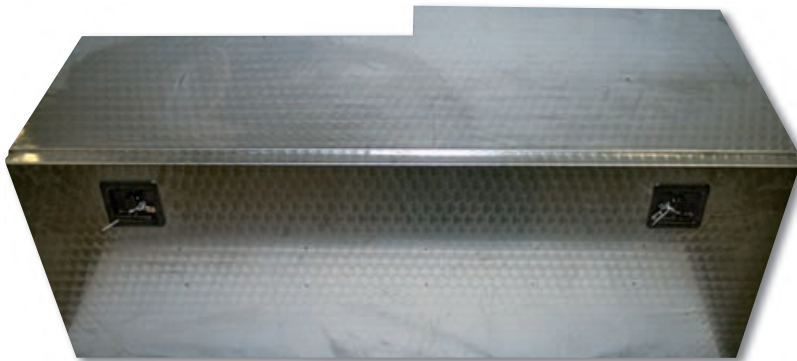

**i** Toolbox made on a drawing with customized measures and model. You can download the request form on our website, in the **"Download"** area and choosing the **"Tailored Toolboxes"** link.

*Cassetta realizzata a disegno con misure e modello personalizzato. Disponibile il modulo di richiesta sul nostro sito Internet, in area "Download", scegliendo il link "Cassette Su Misura".*

### LEGENDA COMPONENTI PER CASSETTE / COMPONENTS LEGEND FOR TOOLBOXES:

Serratura in Pvc PVC Lock  <b>M100061</b>	Serratura Inox/Pvc S. Steel/PVC Lock  <b>M10017</b>	Serratura Inox S. Steel Lock  <b>M10018</b>	Serratura Inox/Frigido S. Steel/Fridge Lock  <b>R18110</b>	Serratura per Serranda Lock for Shutter  <b>C70508</b>	Chiusura a Leva Lever Lock  <b>C70505M</b>	Gancio in Gomma Rubber Hinge  <b>65000</b>	Blocchetto Chiave Key Lock  <b>M100013</b>	Lucchetto Padlock  <b>R60102</b>	Chiave Univ. per varie Chiusure Universal Key for Multiple Locks  <b>Solo per art. M100061 M10017 e M10018 Only for art. M100061 M10017 and M10018</b>
Maniglia con molla Handle with spring  <b>R72110</b>	Sigillante per interno Interior Sealant  <b>T75105</b>	Lettere in Rilievo > 10pz Raised Letters  <b>ABC</b>	Pistone a Gas Gas Piston 	Catenella di tenuta Chain 	Divisorio Divider 	Ripiano Shelf 	Cassetti Scorrevoli Drawers 		

### LEGENDA SUPPORTI PER CASSETTE / SUPPORTS LEGEND FOR TOOLBOXES:

Coppia Staffe Zincate Pair of Galvanized Brackets 	Coppia Staffe Zincate con Supporto Pair of Galvanized Brackets with Support 	Coppia Staffe Lamiera Zincata Pair of Galvanized Brackets 	Coppia Staffe Verniciate Pair of Black Painted Brackets 	Coppia Staffe Zincate Pair of Galvanized Brackets 	Coppia Staffe Inox Pair of Stainless Steel Brackets 	Coppia Staffe Inox AISI 304 Pair of Stainless Steel Brackets 
--	--	--	--	--	--	---

# Brackets for Toolboxes



## Pair of Black Painted Universal Brackets

*Coppia Staffe Universali Verniciate Nero*

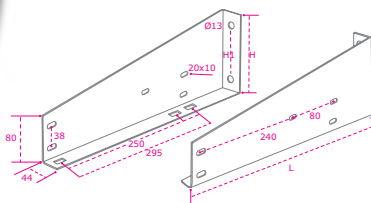

ARTICLE	L	H	H1	SP	KG	
S60000	455	155	105	30/10	3,60	2



TKcert RINA UNI EN ISO 15614-1:2012



## Pair of Stainless Steel Universal Brackets

*Coppia Staffe Universali Inox*

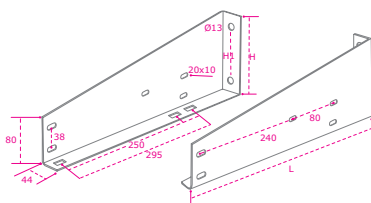

ARTICLE	L	H	H1	SP	KG	
S62000	455	155	105	30/10	3,60	2



TKcert RINA UNI EN ISO 15614-1:2012

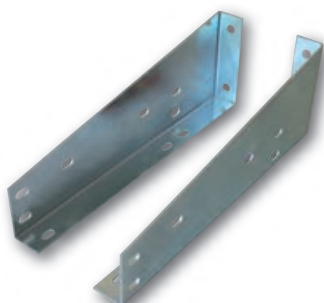

## Pair of Galvanized Universal Brackets

*Coppia Staffe Universali Zincate*

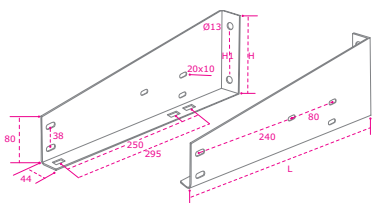

ARTICLE	L	H	H1	SP	KG	
S64000	455	155	105	30/10	3,60	2



TKcert RINA UNI EN ISO 15614-1:2012



## Pair of Black Painted Universal Brackets

*Coppia Staffe Universali Verniciate Nero*

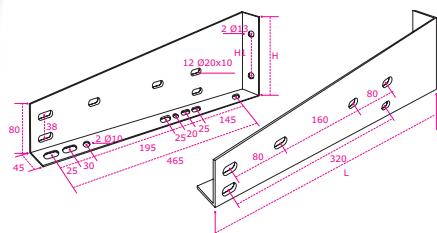

ARTICLE	L	H	H1	SP	KG	
S61000	530	200	105	30/10	3,90	2



TKcert RINA UNI EN ISO 15614-1:2012



## Pair of Stainless Steel Universal Brackets

*Coppia Staffe Universali Inox*

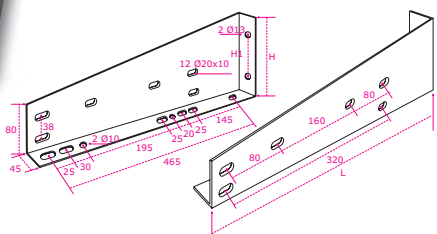

ARTICLE	L	H	H1	SP	KG	
S63000	530	200	105	30/10	3,90	2



TKcert RINA UNI EN ISO 15614-1:2012

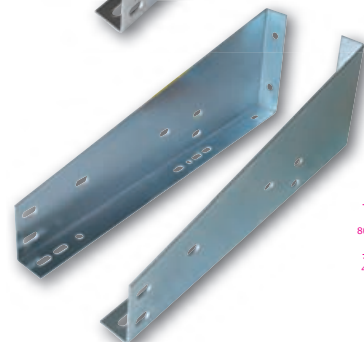

## Pair of Galvanized Universal Brackets

*Coppia Staffe Universali Zincate*

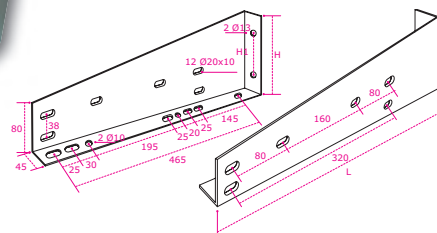

ARTICLE	L	H	H1	SP	KG	
S65000	530	200	105	30/10	3,90	2



TKcert RINA UNI EN ISO 15614-1:2012

# Brackets for Toolboxes

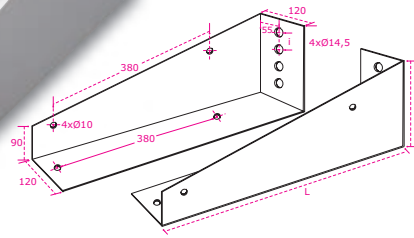
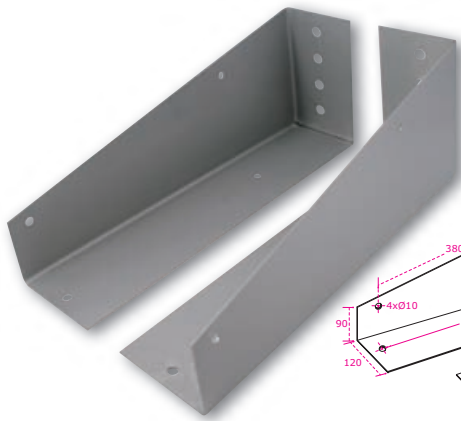

## Pair of Stainless Steel Brackets

*Coppia Staffe Acciaio Inox AISI 304*

ARTICLE	L	H	i	SP	KG	
C70615	720	230	5	25/10	7,70	2

**TKcert** RINA UNI EN ISO 15614-1:2012

**i** Recommended for Tractor Scania New Generation.  
Consigliate per Trattore Scania New Generation.

## Pair of Galvanized Brackets

*Coppia Staffe Lamiera Zincata*

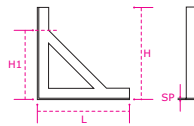

ARTICLE	L	H	H1	SP	KG	
C70630	270	270	160	35/10	2,45	2
C70620	350	350	280	35/10	3,18	2
C70621	500	500	380	35/10	4,48	2
C70622	600	600	460	35/10	5,68	2
C70623	700	700	530	35/10	6,40	2

**TKcert** RINA UNI EN ISO 15614-1:2012

## Pair of Galvanized Brackets

*Coppia Staffe Lamiera Zincata*

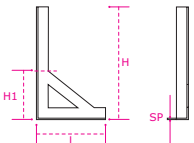
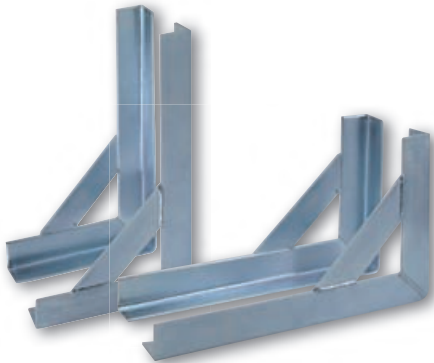

ARTICLE	L	H	H1	SP	KG	
C70631	340	200	160	35/10	2,45	2

**TKcert** RINA UNI EN ISO 15614-1:2012

## Pair of Galvanized Brackets with Support

*Coppia Staffe Zincate con Supporto*

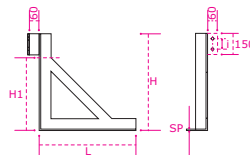

ARTICLE	L	H	H1	SP	i	KG	
C70626	500	500	380	35/10	100	2,70	2
C70624	600	600	460	35/10	100	3,17	2

**TKcert** RINA UNI EN ISO 15614-1:2012

## Pair of Galvanized Brackets

*Coppia Staffe Lamiera Zincata*

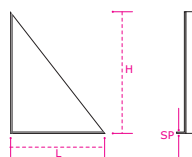
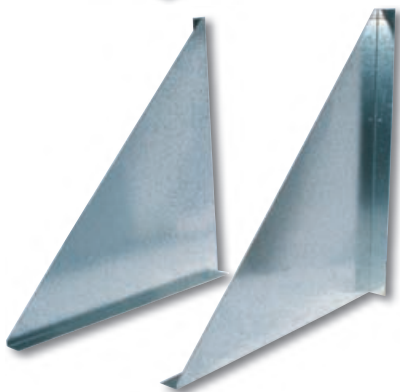

ARTICLE	L	H	SP	KG	
C70601	450	350	20/10	2,90	2
C70602	500	400	20/10	3,60	2
C70604	600	600	20/10	5,60	2

# Accessories for Toolboxes



## Pvc Key Lock

Serratura Pvc per Cassetta

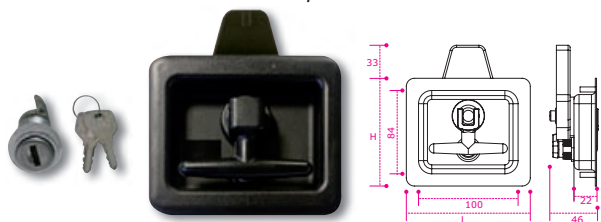

ARTICLE	L	H	SP	KG	
M100061	120	105	8	0,21	1

ARTICLE Key Lock Blocchetto chiave

M100013	32	-	18	0,05	1
---------	----	---	----	------	---

## Stainless Steel Key Lock

Serratura Inox per Cassetta

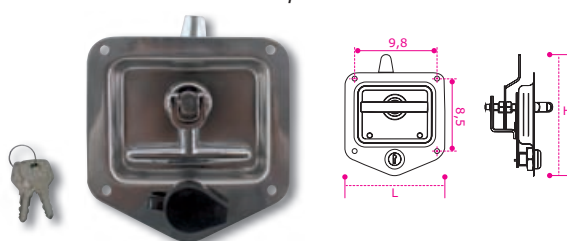

ARTICLE	L	H	KG	
M10011	120	130	0,51	1

## Stainless Steel Key Lock

Serratura Inox per Cassetta con Riscontro in PVC

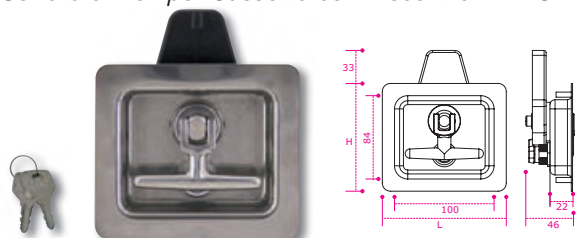

ARTICLE	L	H	KG	
M10017	120	105	0,51	1

## Stainless Steel Key Lock

Serratura Inox per Cassetta con Riscontro Inox

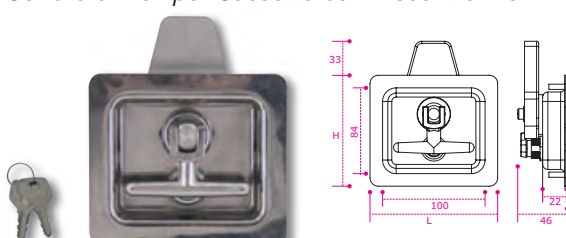

ARTICLE	L	H	KG	
M10018	120	105	0,55	1

## Stainless Steel Key Lock

Serratura Inox per Cassetta

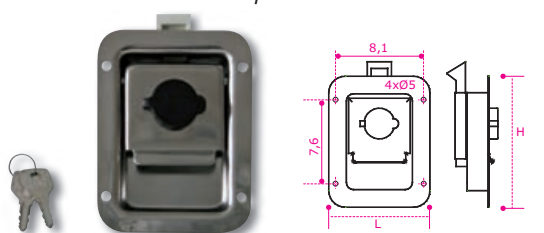

ARTICLE	L	H	KG	
R18110	95	120	0,35	1

## Stainless Steel Key Lock

Serratura Inox per Cassetta

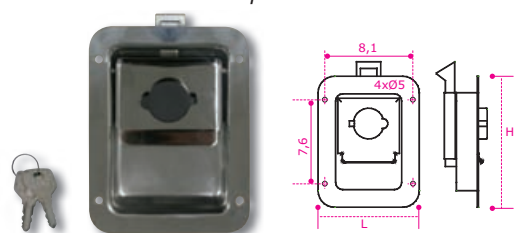

ARTICLE	L	H	KG	
R00438	140	108	0,47	1

## Galvanized Steel Lever Lock

Chiusura a leva zincata

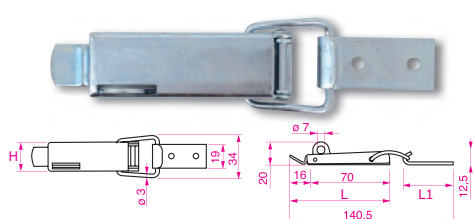

ARTICLE	L	L1	H	KG	
C70505M	86	43	23	0,12	1

## PVC Key Lock

Serratura Pvc per Cassetta in Termoplastica



ARTICLE	L	H	KG	
M60001	83	42	0,10	1

**i** Handle for toolbox C70001 - C70002 - C60001 - C60002 - C60003 - C60024 - C60007 - C60009. It is supplied WITHOUT fixing kit, this can be requested in accordance with the toolbox code.  
Maniglia per cassetta C70001 - C70002 - C60001 - C60002 - C60003 - C60024 - C60007 - C60009. Viene fornita SENZA ferramenta interna che può essere richiesta in base al codice della cassetta.

# Documents Holder



## PPE Extractable Document Holder Made by Injection

Portadocumenti PPE ad Iniezione A4 Sfilabile

ARTICLE	L	H	P	i	KG	
C30010	285	370	55	265	0,70	6

**P** Printable space for customization Spazio serigrafabile

C30010P 130x35

H6000 Cliché for print Cliché per stampa

**i** Possibility to customise. Padlock on request.  
Possibilità di personalizzazione, lucchetto solo su richiesta.

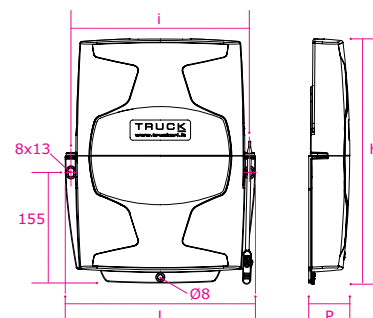

## Padlock Lucchetto

ARTICLE	L	H	KG	
R60102	25	15	0,02	1



## PVC A4 Document Holder

Portadocumenti PVC A4

ARTICLE	L	H	P	i	KG	
C30001/2	280	350	60	260	0,70	50

**P** Printable space for customization Spazio serigrafabile

C30001/2P 113x29

H6000 Cliché for print Cliché per stampa

**i** Polypropylene A4 document holder, closure without key, 3 holes Ø8 for application. Possibility to customise.  
Portadocumenti in Polipropilene, formato A4, serraggio senza chiave, 3 fori di diametro 8 per applicazione. Possibilità di personalizzazione.

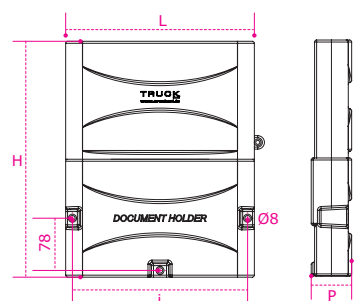



# Documents Holder



## PVC A4 Document Holder

Portadocumenti PVC A4

ARTICLE	L	H	P	i	KG	
C30015	275	340	50	296	0,70	50

**P** Printable space for customization Spazio serigrafabile

C30015P	60x60
---------	-------

H6000	Cliché for print Clichè per stampa
-------	------------------------------------

**i** Possibility to customise. Padlock on request.  
Possibilità di personalizzazione, lucchetto solo su richiesta.

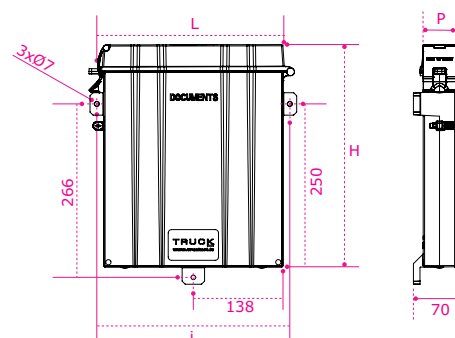

## Padlock Lucchetto

ARTICLE	L	H	KG	
R60102	25	15	0,02	1

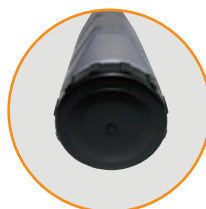

## PVC Tube Document Holder

Portadocumenti PVC a tubo

ARTICLE	D	H	P	i	KG	
C30011	120	350	140	90	0,60	1

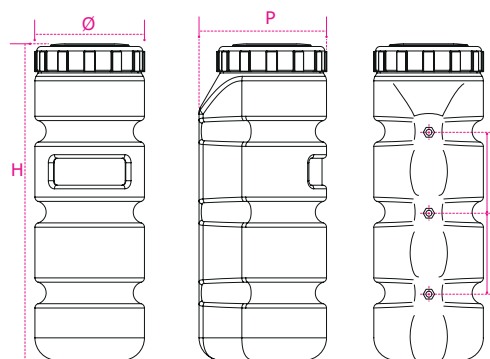

# Documents Holder



## Tarpaulin Document Holder

Portadocumenti Telonato

ARTICLE	L	H	KG	
010108A	360	260	0,30	1

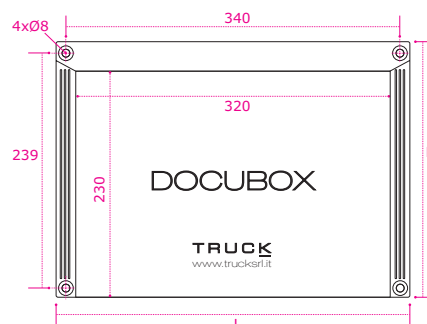

## Stainless Steel Document Holder

Portadocumenti Inox Lucido



ARTICLE	L	H	P	i	SP	KG	
C30002	245	210	50	275	8/10	1,25	1

**P** Printable space for customization Spazio serigrafabile

C30002P	110x30
---------	--------

H6000	Cliché for print Cliché per stampa
-------	------------------------------------

**TKcert** RINA UNI EN ISO 15614-1:2012

**i** Possibility to customise.  
Possibilità di personalizzazione.

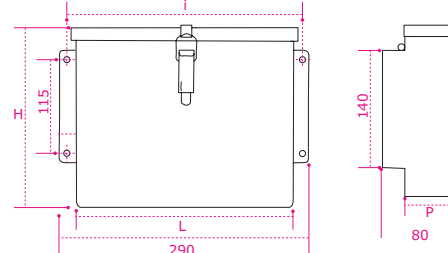

## Flowered Stainless Steel Document Holder

Portadocumenti Inox Fiore



ARTICLE	L	H	P	SP	KG	
C30001	300	210	80	15/10	1,80	20

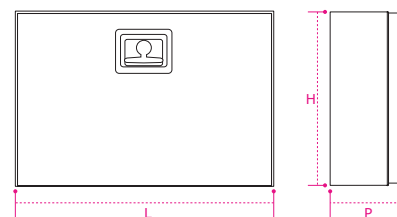

# Mudguards

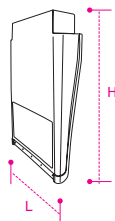
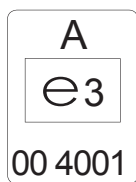

## PVC Flat Mudguard

Parafango PVC Piatto

ARTICLE	CUSTOM.	L	H	KG	
N50001	N50001P	470	730	1,95	1

**i** Flat mudguard with homologated antispray mudflap 91/226/EEC, for newly registered vehicles and for vehicle revisions > year 2007. Attention: the homologation is valid only if mounted with the Mudflap PN4025.

Parafango con antispray omologato Dir. 91/226/EEC, per mezzi di nuova immatricolazione e per revisione mezzi > anno 2007. Attenzione: l'omologazione è valida solo se montato con Paraspruzzo PN4025

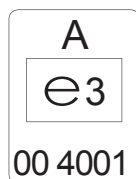
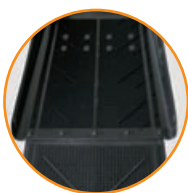

ARTICLE	CUSTOM.	L	H	KG	
N50007	N50007P	470	940	2,80	1

## PVC Flat Mudguard with Homologated Antispray Mudflap

Parafango PVC Piatto completo di Paraspruzzo Antispray Omologato

**i** Polypropylene mudguard with homologated antispray mudflap 91/226/EED, for newly registered vehicles and for vehicle revisions > year 2007, attached with black rivets 7.8x18 wide at the top.

Parafango polipropilene con paraspruzzo antispray premontato, omologato Dir. 91/226/EEC, per mezzi di nuova immatricolazione e per revisione mezzi > anno 2007, inserito con rivetti neri 7,8x18 testa larga.

## Homologated Antispray Mudflap For Mudguard N50001

Paraspruzzo Antispray Omologato per Parafango N50001

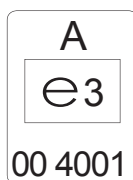

ARTICLE		L	H	SP	KG	
PN4025	Neutral Neutro	400	250	14	0,85	100
PN40251	1 Colour 1 Colore	400	250	14	0,85	100
PN40252	2 Colours 2 Colori	400	250	14	0,85	100

**i** Homologated antispray mudflap 91/226/EEC, for newly registered vehicles and for vehicle revisions > year 2007. Attention: the homologation is valid only if mounted on the Mudguard N50001.

Paraspruzzo antispray omologato Dir. 91/226/EEC, per mezzi di nuova immatricolazione e per revisione mezzi > anno 2007. Attenzione: l'omologazione è valida solo se montato nel Parafango N50001.

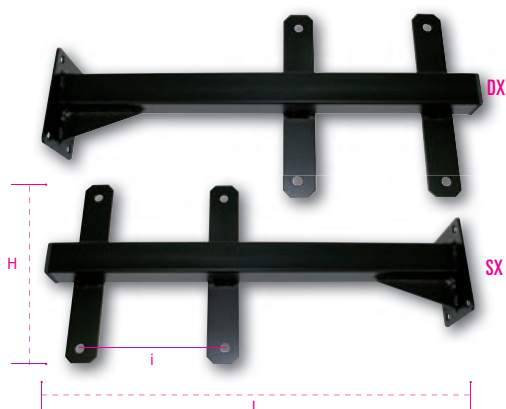

## Black Painted Reinforced Bracket 4 Holes

Staffa Supporto 4 Fori Rinforzata Verniciata Nera

ARTICLE	DIR	L	H	i	KG	
N50005	DX	500	122	85	1,90	100
N50006	SX	500	122	85	1,90	100

TKcert RINA UNI EN ISO 15614-1:2012

## Lateral Antispray With PVC Profile

Antispray Laterale con profilo PVC

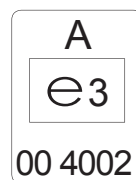
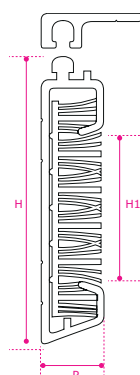

ARTICLE	L	H	H1	P	KG	
N50004	3700	155	100	22	3,00	1
N50008	3700	100	50	22	2,00	1



## Thermoplastic Mudguard

Parafango Termoplastico

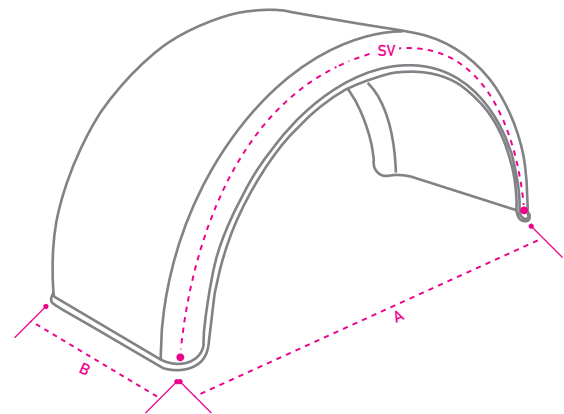

**i** Polypropylene mudguard, good resistance to shocks and has a long duration, possibility to customise, also in small quantities.  
 Parafango in polipropilene ottima resistenza agli urti e durata nel tempo, possibilità di personalizzazione anche per piccole quantità.

ARTICLE	CUSTOM.	A	B	SV	KG
P49000	P49000P	750	390	1180	1,25
P50000	P50000P	780	380	1220	1,30
P50002	P50002P	880	280	1380	1,40
P50003	P50003P	880	400	1380	2,20
P50004	P50004P	880	450	1380	2,30
P50008	P50008P	1000	500	1650	3,50
P50011	P50011P	1150	550	1720	3,20

ARTICLE	CUSTOM.	A	B	SV	KG
P50012	P50012P	1150	600	1780	3,70
P50013	P50013P	1280	650	1900	5,10
P50014	P50014P	1300	450	1900	3,80
P50015	P50015P	1300	450	2100	4,10
P50016	P50016P	1300	690	1900	5,70
P50017	P50017P	1340	660	2100	6,10

# Mudguards



## Thermoplastic Mudguard with Homologated Antispray Mudflap

Parafango Termoplastico con Paraspruzzo Antispray Omologato Premontato

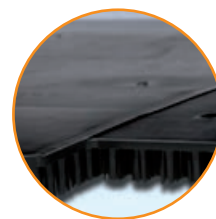
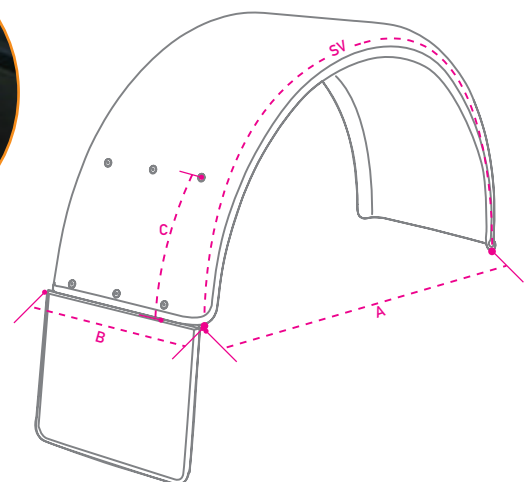

A  
e13  
0005

**i** Polypropylene mudguard with homologated antispray mudflap 91/226/EEC, for newly registered vehicles and for vehicle revisions > year 2007, attached with black rivets 7.8x18 wide at the top and an internal reinforcement washer 8x24. Possibility to customise the mudguard and the mudflap also in small quantities.

Parafango polipropilene con paraspruzzo antispray premontato, omologato Dir. 91/226/EEC, per mezzi di nuova immatricolazione e per revisione mezzi > anno 2007, inserito con rivetti neri 7,8x18 testa larga e rondella di rinforzo interna 8x24. Su richiesta possibilità di personalizzazione su parafango e paraspruzzo anche in piccole quantità.

ARTICLE	CUSTOM.	A	B	SV	C	KG
Q40008	Q40008P	1000	500	1650	265	4,58
Q40011	Q40011P	1150	550	1720	265	4,50
Q40012	Q40012P	1150	600	1780	265	4,65
Q40014	Q40014P	1300	450	1900	265	4,88

ARTICLE	CUSTOM.	A	B	SV	C	KG
Q40015	Q40015P	1300	450	2100	265	5,18
Q40013	Q40013P	1280	660	1900	265	7,00
Q40017	Q40017P	1340	660	2100	265	7,18

## Thermoplastic Mudguard with Nylon Fixing

Parafango Termoplastico Premontato con Alette in Nylon



Polypropylene mudguard with nylon fixing Ø42, Ø48 and Ø54, complete with 4 adjustable support rings, packaged separately, allowing for optimum storage. Possibility to customise also in small quantities.

Parafango polipropilene premontato con alette in nylon di Ø42, Ø48 e Ø54, complete di 4 anelli di supporto regolabili imballati a parte per consentirne lo stoccaggio ottimale. Su richiesta possibilità di personalizzazione anche in piccole quantità.



ARTICLE	CUSTOM.	A	B	SV	C	KG
Q50003	Q50003P	880	400	1380	265	3,08
Q50004	Q50004P	880	450	1380	265	3,28
Q50008	Q50008P	1000	500	1650	265	4,58
Q50011	Q50011P	1150	550	1720	265	4,50
Q50012	Q50012P	1150	600	1780	265	4,65

ARTICLE	CUSTOM.	A	B	SV	C	KG
Q50014	Q50014P	1300	450	1900	265	4,88
Q50015	Q50015P	1300	450	2100	265	5,18
Q50013	Q50013P	1280	660	1900	265	7,00
Q50017	Q50017P	1340	660	2100	265	7,18



ARTICLE	CUSTOM.	A	B	SV	C	KG
Q70008	Q70008P	1000	500	1650	265	4,58
Q70011	Q70011P	1150	550	1720	265	4,50
Q70012	Q70012P	1150	600	1780	265	4,65
Q70014	Q70014P	1300	450	1900	265	4,88

ARTICLE	CUSTOM.	A	B	SV	C	KG
Q70015	Q70015P	1300	450	2100	265	5,18
Q70013	Q70013P	1280	660	1900	265	7,00
Q70017	Q70017P	1340	660	2100	265	7,18



ARTICLE	CUSTOM.	A	B	SV	C	KG
Q60008	Q60008P	1000	500	1650	265	4,58
Q60011	Q60011P	1150	550	1720	265	4,50
Q60012	Q60012P	1150	600	1780	265	4,65
Q60014	Q60014P	1300	450	1900	265	4,88

ARTICLE	CUSTOM.	A	B	SV	C	KG
Q60015	Q60015P	1300	450	2100	265	5,18
Q60013	Q60013P	1280	660	1900	265	7,00
Q60017	Q60017P	1340	660	2100	265	7,18

# Mudguards

## Thermoplastic Mudguard with Nylon Fixing and Antispray Mudflap

Parafango Termoplastico Premontato con Alette Nylon e Paraspruzzo Antispray



**i** Polypropylene mudguard with nylon fixing and homologated antispray mudflap 91/226/EED, for newly registered vehicles and for vehicle revisions > year 2007, attached with black rivets 7.8x18 wide at the top and internal reinforcement washer 8x24. Possibility to customise the mudguard and the mudflap, also in small quantities.

Parafango polipropilene con alette e paraspruzzo antispray premontato, omologato Dir. 91/226/EEC, per mezzi di nuova immatricolazione e per revisione mezzi > anno 2007, inserito con rivetti neri 7,8x18 testa larga e rondella di rinforzo interna 8x24. Su richiesta possibilità di personalizzazione su parafango e paraspruzzo anche in piccole quantità.

A  
e13  
0005



ARTICLE	CUSTOM.	A	B	SV	C	KG
Q51008	Q51008P	1000	500	1650	265	4,58
Q51011	Q51011P	1150	550	1720	265	4,50
Q51012	Q51012P	1150	600	1780	265	4,65
Q51014	Q51014P	1300	450	1900	265	4,88

ARTICLE	CUSTOM.	A	B	SV	C	KG
Q51015	Q51015P	1300	450	2100	265	5,18
Q51013	Q51013P	1280	660	1900	265	7,00
Q51017	Q51017P	1340	660	2100	265	7,18



ARTICLE	CUSTOM.	A	B	SV	C	KG
Q71008	Q71008P	1000	500	1650	265	4,58
Q71011	Q71011P	1150	550	1720	265	4,50
Q71012	Q71012P	1150	600	1780	265	4,65
Q71014	Q71014P	1300	450	1900	265	4,88

ARTICLE	CUSTOM.	A	B	SV	C	KG
Q71015	Q71015P	1300	450	2100	265	5,18
Q71013	Q71013P	1280	660	1900	265	7,00
Q71017	Q71017P	1340	660	2100	265	7,18



ARTICLE	CUSTOM.	A	B	SV	C	KG
Q61008	Q61008P	1000	500	1650	265	4,58
Q61011	Q61011P	1150	550	1720	265	4,50
Q61012	Q61012P	1150	600	1780	265	4,65
Q61014	Q61014P	1300	450	1900	265	4,88

ARTICLE	CUSTOM.	A	B	SV	C	KG
Q61015	Q61015P	1300	450	2100	265	5,18
Q61013	Q61013P	1280	660	1900	265	7,00
Q61017	Q61017P	1340	660	2100	265	7,18

## Thermoplastic Mudguard with Black Painted Fixing Ø42 or with Antispray Mudflap

Parafango Termoplastico Premontato con Alette diametro 42 verniciate o con Paraspruzzo Antispray

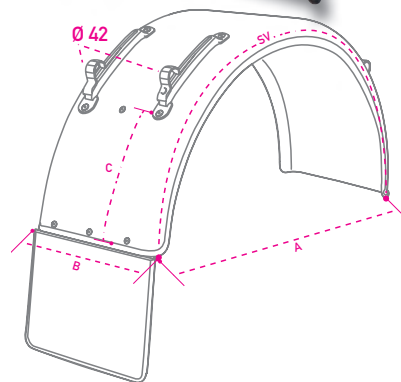

A  
e13  
0005

**i** Polypropylene mudguard with black painted fixing and homologated antispray mudflap 91/225/EEC, for newly registered vehicles and for vehicle revisions > year 2007, attached with black rivets 7.8x18 wide at the top and internal reinforcement washer 8x24. Possibility to customise the mudguard and mudflap, also in small quantities. *Parafango polipropilene con alette verniciate e paraspruzzo antispray premontato, omologato Dir. 91/226/EEC, per mezzi di nuova immatricolazione e per revisione mezzi > anno 2007, inserito con rivetti neri 7,8x18 testa larga e rondella di rinforzo interna 8x24. Su richiesta possibilità di personalizzazione su parafango e paraspruzzo anche in piccole quantità.*

**mudguard with fixing**  
parafango premontato

ARTICLE	CUSTOM.	A	B	SV	C	KG
M40003	M40003P	880	400	1380	265	3,08
M40004	M40004P	880	450	1380	265	3,28
M40008	M40008P	1000	500	1650	265	4,58
M40011	M40011P	1150	550	1720	265	4,50
M40012	M40012P	1150	600	1780	265	4,65

ARTICLE	CUSTOM.	A	B	SV	C	KG
M40014	M40014P	1300	450	1900	265	4,88
M40015	M40015P	1300	450	2100	265	5,18
M40013	M40013P	1280	660	1900	265	7,00
M40017	M40017P	1340	660	2100	265	7,18

**mudguard with fixing and mudflap**  
paraf.premontato completo di paraspruzzo

ARTICLE	CUSTOM.	A	B	SV	C	KG
M50008	M50008P	1000	500	1650	265	4,58
M50011	M50011P	1150	550	1720	265	4,50
M50012	M50012P	1150	600	1780	265	4,65
M50014	M50014P	1300	450	1900	265	4,88

ARTICLE	CUSTOM.	A	B	SV	C	KG
M50015	M50015P	1300	450	2100	265	5,18
M50013	M50013P	1280	660	1900	265	7,00
M50017	M50017P	1340	660	2100	265	7,18



# Mudguards



## Thermoplastic Mudguard with Galvanized Fixing Ø42 or with Antispray Mudflap

Parafango Termoplastico Premontato con Alette diametro 42 zincate o con Paraspruzzo Antispray

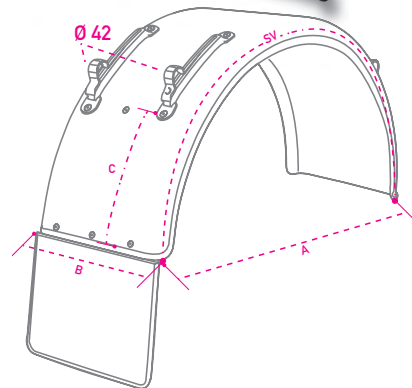

A  
e13  
0005

**i** Polypropylene mudguard with galvanized fixing and homologated antispray mudflap 91/225/EEC, for newly registered vehicles and for vehicle revisions > year 2007, attached with black rivets 7.8x18 wide at the top and internal reinforcement washer 8x24. Possibility to customise the mudguard and mudflap, also in small quantities. Parafango polipropilene con alette zincate e paraspruzzo antispray premontato, omologato Dir. 91/226/EEC, per mezzi di nuova immatricolazione e per revisione mezzi > anno 2007, inserito con rivetti neri 7,8x18 testa larga e rondella di rinforzo interna 8x24. Su richiesta possibilità di personalizzazione su parafango e paraspruzzo anche in piccole quantità.

**mudguard with fixing**  
parafango premontato

ARTICLE	CUSTOM.	A	B	SV	C	KG
M60003	M60003P	880	400	1380	265	3,08
M60004	M60004P	880	450	1380	265	3,28
M60008	M60008P	1000	500	1650	265	4,58
M60011	M60011P	1150	550	1720	265	4,50
M60012	M60012P	1150	600	1780	265	4,65

ARTICLE	CUSTOM.	A	B	SV	C	KG
M60014	M60014P	1300	450	1900	265	4,88
M60015	M60015P	1300	450	2100	265	5,18
M60013	M60013P	1280	660	1900	265	7,00
M60017	M60017P	1340	660	2100	265	7,18

**mudguard with fixing and mudflap**  
paraf.premontato completo di paraspruzzo

ARTICLE	CUSTOM.	A	B	SV	C	KG
M70008	M70008P	1000	500	1650	265	4,58
M70011	M70011P	1150	550	1720	265	4,50
M70012	M70012P	1150	600	1780	265	4,65
M70014	M70014P	1300	450	1900	265	4,88

ARTICLE	CUSTOM.	A	B	SV	C	KG
M70015	M70015P	1300	450	2100	265	5,18
M70013	M70013P	1280	660	1900	265	7,00
M70017	M70017P	1340	660	2100	265	7,18



## Flat Top Thermoplastic Mudguard

*Parafango Termoplastico Base Piana*

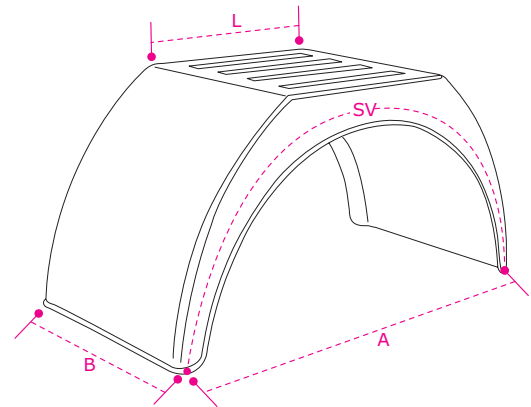

ARTICLE	CUSTOMIZED	A	B	SV	L	KG
T50020	T50020P	880	270	1450	420	1,60
T50019	T50019P	900	450	1450	420	2,70

ARTICLE	CUSTOMIZED	A	B	SV	L	KG
T50018	T50018P	1000	510	1725	510	3,70
T50021	T50021P	1100	550	1700	640	4,80



## Flat Top Thermoplastic Mudguard with Antispray Mudflap

*Parafango Termoplastico Base Piana con Paraspruzzo Premontato*

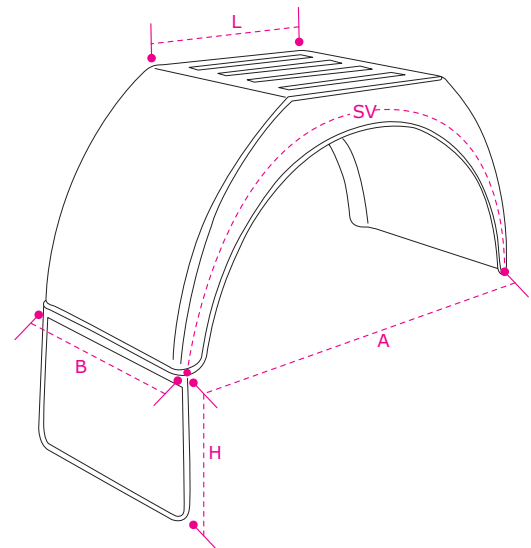

ARTICLE	CUSTOMIZED	A	B	SV	L	H	KG
Q40019	Q40019P	900	450	1450	420	300	3,80
Q40018	Q40018P	1000	510	1725	510	300	5,05
Q40021	Q40021P	1100	550	1700	640	300	5,25

**i** Polypropylene flat top mudguard in particular indicated for vehicles with support and without top mounting brackets with a sealant and self-drilling screws.  
*Parafango polipropilene base piana particolarmente adatto per mezzi con supporto senza staffe sulla base superiore con sigillanti e viti autoforanti.*

# Mudguards

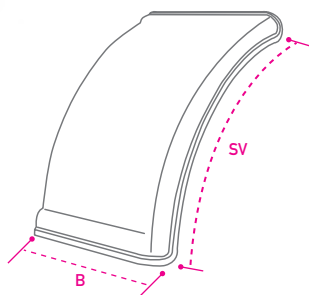

## Thermoplastic Half Mudguard

Mezzo Parafango Termoplastico

ARTICLE	CUSTOM.	B	SV	KG
P50059	P50059P	450	700	1,20
P50063	P50063P	450	800	1,20
P50060	P50060P	500	700	1,30
P50066	P50066P	550	500	1,10
P50061	P50061P	600	700	1,70
P50062	P50062P	600	550	1,30
P60063	P60063P	650	600	2,00
P60064	P60064P	650	700	2,10
P60066	P60066P	650	800	2,30

! Request your customized cut.  
Richiedi il tuo taglio personalizzato.

## Thermoplastic Half Mudguard with Antispray Mudflap

Mezzo Parafango Termoplastico con Paraspruzzo Antispray Premontato

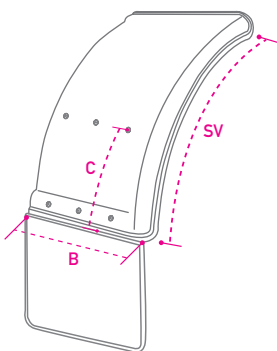

ARTICLE	CUSTOM.	B	SV	KG
Q450059	Q450059P	450	700	2,20
Q450063	Q450063P	450	800	2,30
Q450060	Q450060P	500	700	2,65
Q450066	Q450066P	550	500	2,55
Q450061	Q450061P	600	700	3,30
Q450062	Q450062P	600	550	2,90
Q460063	Q460063P	650	600	3,70
Q460064	Q460064P	650	700	3,80
Q460066	Q460066P	650	800	4,00

! Request your customized cut.  
Richiedi il tuo taglio personalizzato.

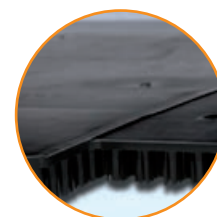

**i** Polypropylene half mudguard with homologated antispray mudflap 91/22/EEC for newly registered vehicles and for vehicle reviews > year 2007, attached with black rivets 7.8x18 wide at the top and internal reinforcement washer 8x24. Possibility to customise the mudguard and the mudflap, also in small quantities.

Mezzo parafango polipropilene con paraspruzzo antispray premontato, omologato Dir. 91/226/EEC, per mezzi di nuova immatricolazione e per revisione mezzi > anno 2007, inserito con rivetti neri 7,8x18 testa larga e rondella di rinforzo interna 8x24. Su richiesta possibilità di personalizzazione su parafango e paraspruzzo anche in piccole quantità.

A  
e13  
0005

## Thermoplastic Half Mudguard with Nylon Fixing

Mezzo Parafango Termoplastico Premontato con Alette in Nylon

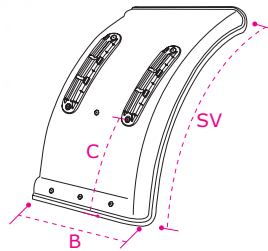

ARTICLE	CUSTOM.	B	SV	C	KG
Q50059	Q50059P	450	700	265	2,10
Q50063	Q50063P	450	800	265	2,20
Q50060	Q50060P	500	700	265	2,25
Q50066	Q50066P	550	500	200	2,10
Q50061	Q50061P	600	700	265	2,70
Q50062	Q50062P	600	550	200	2,50
Q60063	Q60063P	650	600	265	2,60
Q60064	Q60064P	650	700	265	2,70
Q60066	Q60066P	650	800	265	2,90

Request your customized cut.  
Richiedi il tuo taglio personalizzato.

## Thermoplastic Half Mudguard with Nylon Fixing and Antispray Mudflap

Mezzo Parafango Termoplastico Premontato con Alette Nylon e Antispray

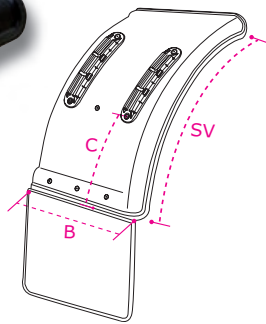

Polypropylene half mudguard with nylon fixing and homologated antispray mudflap 91/226/EEC, attached with black rivets 7.8x18 wide at the top and internal reinforcement washer 8x24. Possibility to customise the mudguard and the mudflap also in small quantities.  
Mezzo parafango polipropilene con alette in nylon e paraspruzzo antispray premontato, omologato Dir. 91/226/EEC, inserito con rivetti neri 7,8x18 testa larga e rondella di rinforzo interna 8x24. Su richiesta possibilità di personalizzazione su parafango e paraspruzzo anche in piccole quantità.

A  
e 13  
0005

ARTICLE	CUSTOM.	B	SV	C	KG
Q51059	Q51059P	450	700	265	2,10
Q51063	Q51063P	450	800	265	2,20
Q51060	Q51060P	500	700	265	2,25
Q51066	Q51066P	550	500	200	2,10
Q51061	Q51061P	600	700	265	2,70
Q51062	Q51062P	600	550	200	2,50
Q61063	Q61063P	650	600	265	2,60
Q61064	Q61064P	650	700	265	2,70
Q61066	Q61066P	650	800	265	2,90

Request your customized cut.  
Richiedi il tuo taglio personalizzato.

## Thermoplastic Half Mudguard with Painted Fixing

Mezzo Parafango Termoplastico Premontato con Alette Verniciate

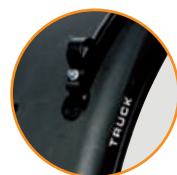
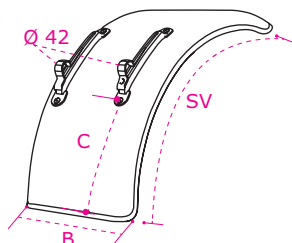

ARTICLE	CUSTOM.	B	SV	C	KG
M40059	M40059P	450	700	265	2,10
M40063	M40063P	450	800	265	2,20
M40060	M40060P	500	700	265	2,25
M40066	M40066P	550	500	200	2,10
M40061	M40061P	600	700	265	2,70
M40062	M40062P	600	550	200	2,50
M30063	M30063P	650	600	265	2,60
M30064	M30064P	650	700	265	2,70
M30066	M30066P	650	800	265	2,90

Request your customized cut.  
Richiedi il tuo taglio personalizzato.

# Mudguards

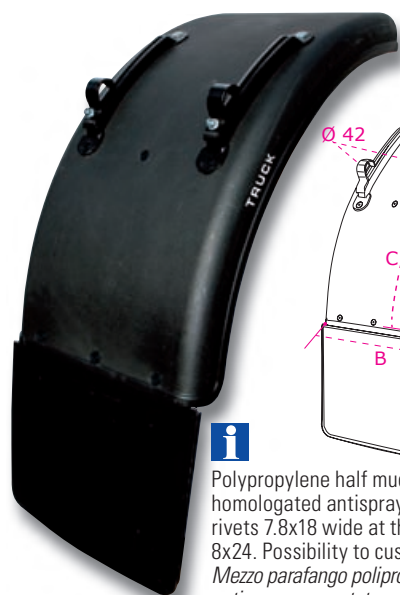

## Thermoplastic Half Mudguard with Painted Fixing and Antispray Mudflap

Mezzo Parafango Termopl. Premontato con Alette Verniciate e Antispray

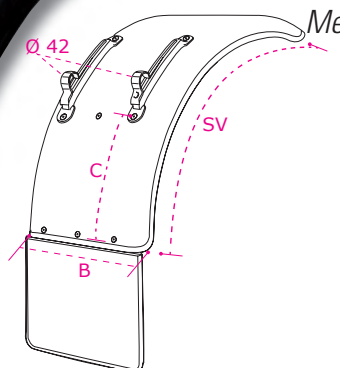

Polypropylene half mudguard with black painted fixing and homologated antispray mudflap 91/226/EEC, attached with black rivets 7.8x18 wide at the top and internal reinforcement washer 8x24. Possibility to customise the mudguard and the mudflap. Mezzo parafango polipropilene con alette verniciate e paraspruzzo antispray premontato, omologato Dir. 91/226/EEC, inserito con rivetti neri 7,8x18 testa larga e rondella di rinforzo interna 8x24. Su richiesta possibilità di personalizzazione su parafango e paraspruzzo, anche in piccole quantità.

A  
e13  
0005

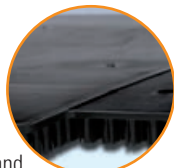

ARTICLE	CUSTOM.	B	SV	C	KG
M50059	M50059P	450	700	265	3,20
M50063	M50063P	450	800	265	3,30
M50060	M50060P	500	700	265	3,30
M50066	M50066P	550	500	200	3,20
M50061	M50061P	600	700	265	2,70
M50062	M50062P	600	550	200	3,30
M60063	M60063P	650	600	265	3,60
M60064	M60064P	650	700	265	3,80
M60066	M60066P	650	800	265	4,10

Request your customized cut.  
Richiedi il tuo taglio personalizzato.

## Thermoplastic Half Mudguard with Galvanized Fixing

Mezzo Parafango Termoplastico Premontato con Alette Zincate

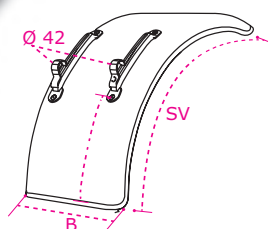
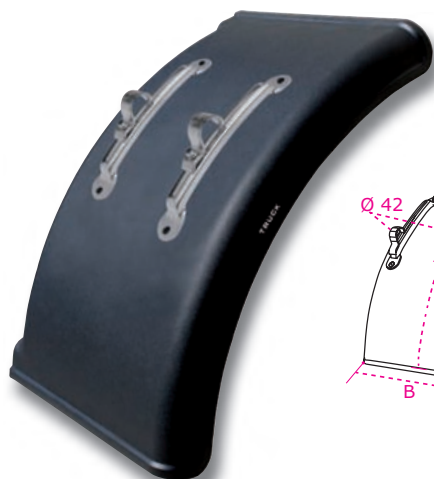

Request your customized cut.  
Richiedi il tuo taglio personalizzato.



ARTICLE	CUSTOM.	B	SV	C	KG
ZM50059	ZM50059P	450	700	265	3,20
ZM50063	ZM50063P	450	800	265	3,30
ZM50060	ZM50060P	500	700	265	3,30
ZM50066	ZM50066P	550	500	200	3,20
ZM50061	ZM50061P	600	700	265	2,70
ZM50062	ZM50062P	600	550	200	3,30
ZM60063	ZM60063P	650	600	265	3,60
ZM60064	ZM60064P	650	700	265	3,80
ZM60066	ZM60066P	650	800	265	4,10

## Thermoplastic Half Mudguard with Galvanized Fixing and Antispray Mudflap

Mezzo Parafango Termoplastico Premontato con Alette Zincate e Paraspruzzo Antispray

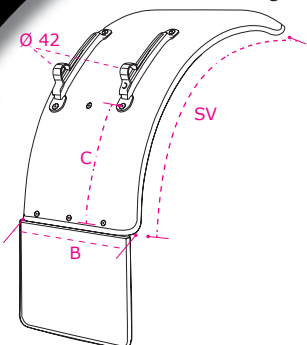
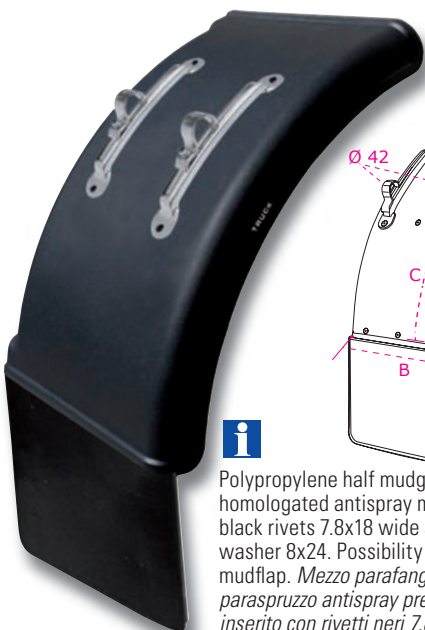

Polypropylene half mudguard with galvanized fixing and homologated antispray mudflap 91/226/EEC, attached with black rivets 7.8x18 wide at the top and internal reinforcement washer 8x24. Possibility to customise the mudguard and the mudflap. Mezzo parafango polipropilene con alette verniciate e paraspruzzo antispray premontato, omologato Dir. 91/226/EEC, inserito con rivetti neri 7,8x18 testa larga e rondella di rinforzo interna 8x24. Su richiesta possibilità di personalizzazione su parafango e paraspruzzo, anche in piccole quantità.

A  
e13  
0005

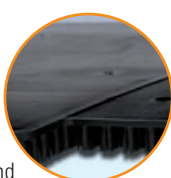

ARTICLE	CUSTOM.	B	SV	C	KG
ZPM50059	ZPM50059P	450	700	265	3,20
ZPM50063	ZPM50063P	450	800	265	3,30
ZPM50060	ZPM50060P	500	700	265	3,30
ZPM50066	ZPM50066P	550	500	200	3,20
ZPM50061	ZPM50061P	600	700	265	2,70
ZPM50062	ZPM50062P	600	550	200	3,30
ZPM60063	ZPM60063P	650	600	265	3,60
ZPM60064	ZPM60064P	650	700	265	3,80
ZPM60066	ZPM60066P	650	800	265	4,10

Request your customized cut.  
Richiedi il tuo taglio personalizzato.



## Flowered Stainless Steel Mudguard

*Parafango Inox Fiore*

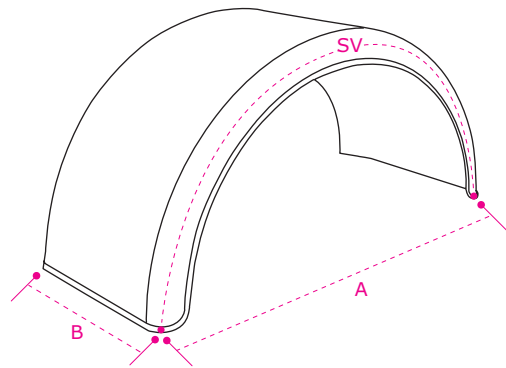
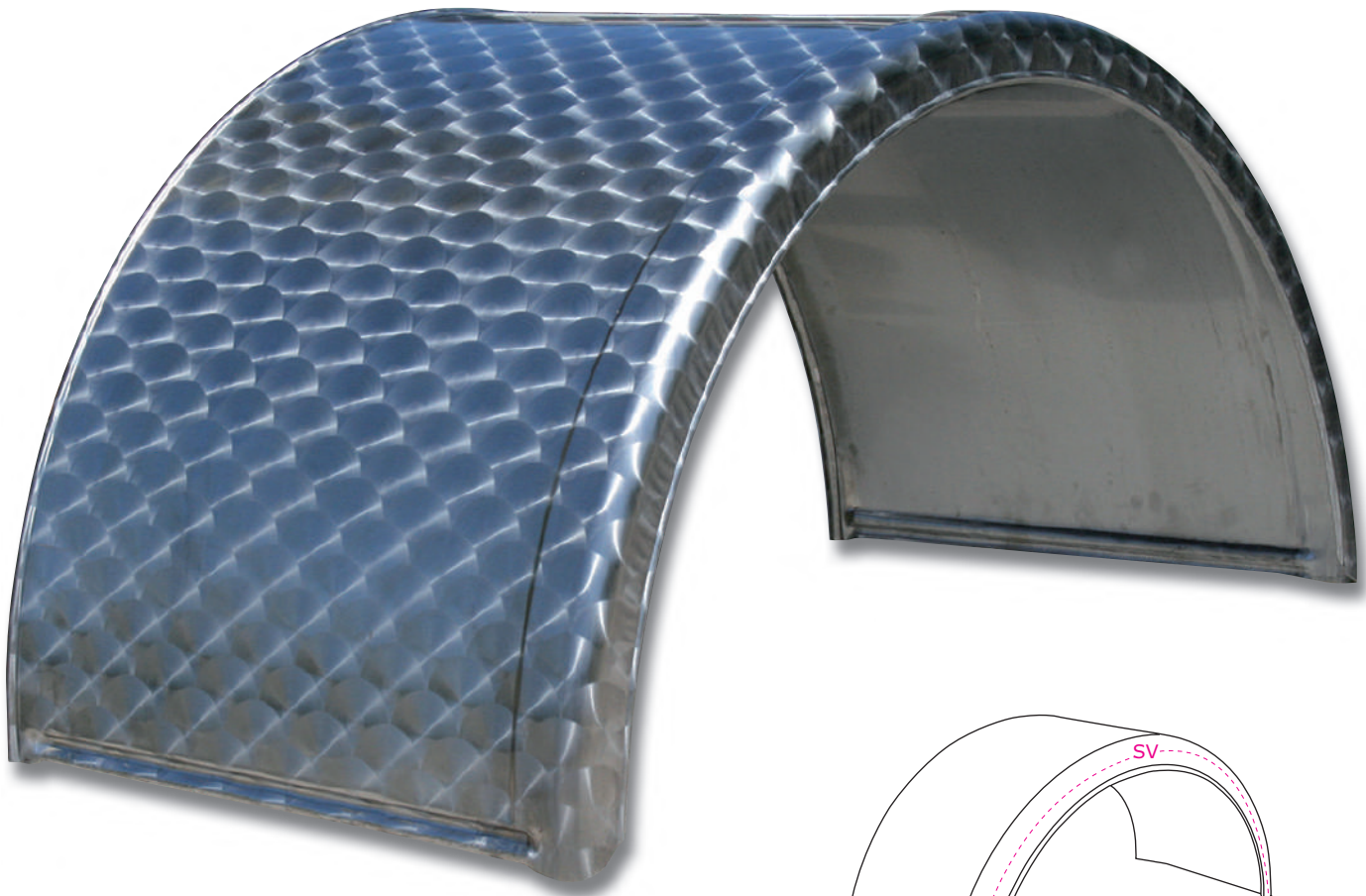

**i** Flowered stainless steel mudguard particularly aesthetic with its round shape, delivered with scratch-resistant adhesive film, special sizes on request.  
*Parafango acciaio inox fiorettato particolare estetica nella forma stondata, consegnato con pellicola adesiva resistente ai graffi, su richiesta misure particolari.*

ARTICLE	A	B	SV	KG
IF10002	880	280	1300	3,60
IF10003	880	400	1360	4,90
IF10004	880	450	1360	5,60
IF10007	1000	450	1500	6,10
IF10008	1000	500	1650	7,20

ARTICLE	A	B	SV	KG
IF10005	1000	550	1650	8,10
IF10010	1110	500	1750	8,20
IF10014	1200	650	1900	11,00
IF10012	1115	600	1800	9,20
IF10013	1115	650	1800	10,20

ARTICLE	A	B	SV	KG
IF10006	1200	550	1850	9,60
IF10009	1200	600	1900	10,50
IF10016	1340	450	1900	8,00
IF10015	1340	450	2100	8,50
IF10017	1340	650	2100	11,00

# Mudguards



## Flowered Stainless Steel Half Mudguard

*Mezzo Parafango Inox Fiore*

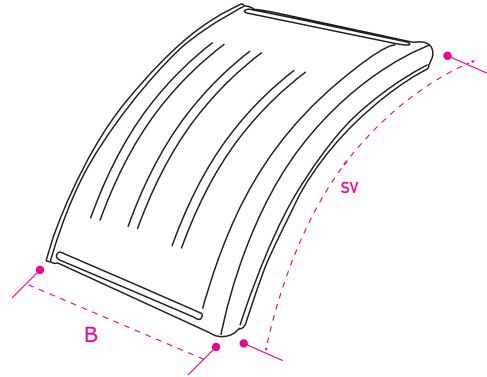
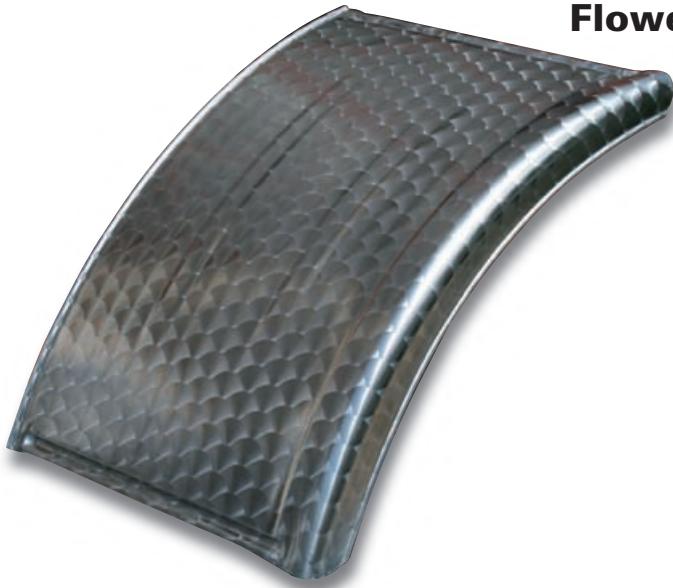

ARTICLE	B	SV	KG
IF20057	500	600	3,20
IF20058	600	600	3,85
IF20059	650	600	3,90

ARTICLE	B	SV	KG
IF20060	500	700	3,20
IF20061	600	700	3,85
IF20062	650	700	3,90

ARTICLE	B	SV	KG
IF20063	500	800	4,50
IF20064	600	800	4,30
IF20065	650	800	4,50

## Flowered Stainless Steel Multi Axle Mudguard

*Parafango Doppio Asse Inox Fiore*

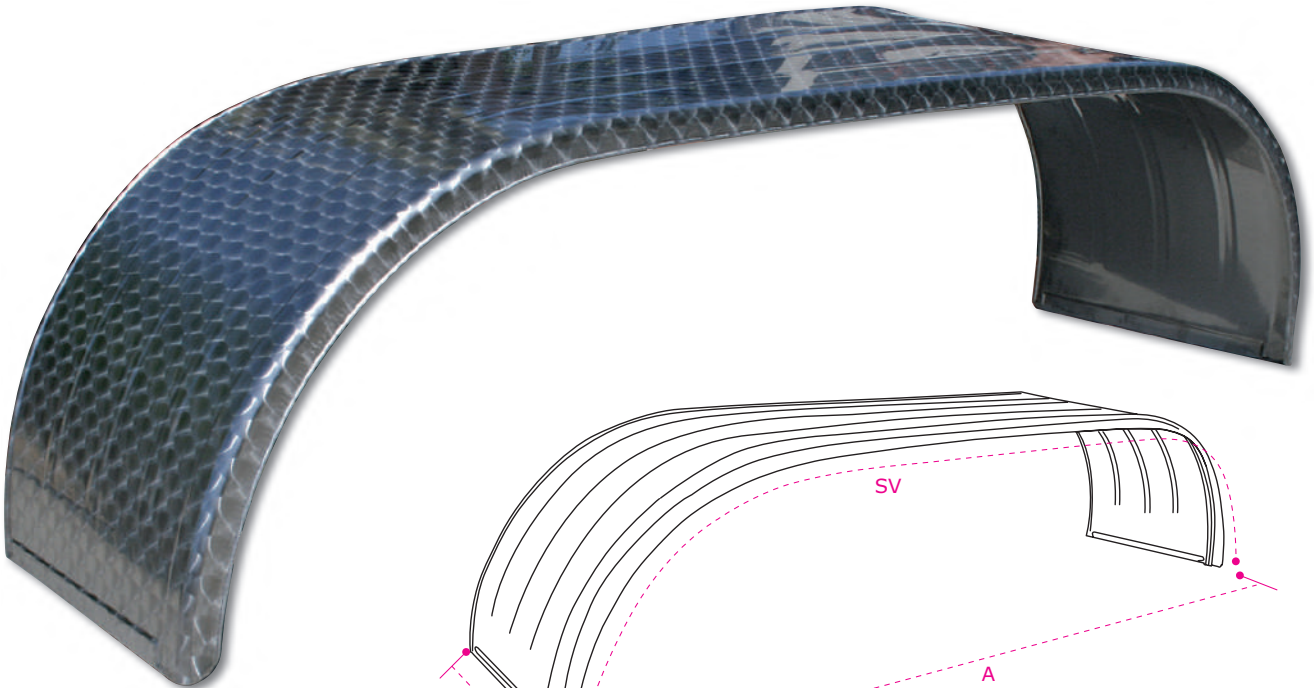

**i** Flowered stainless steel double axle mudguard particularly aesthetic with its round shape, delivered with scratch-resistant adhesive film, special sizes on request.  
*Parafango acciaio inox fiorettato doppio asse particolare estetica nella forma stondata, consegnato con pellicola adesiva resistente ai graffi, su richiesta misure particolari.*

ARTICLE	A	B	SV	KG
IF10025	2740	650	3500	19,5
IF10026	3950	650	4780	29,5



## Flowered Stainless Steel Mudguard with Rubber Edge

*Parafango Inox Fiore Bordo Gomma*



**i** Flowered stainless steel mudguard with a rubber edge, particularly aesthetic with its round shape, delivered with scratch-resistant adhesive film, special sizes on request. *Parafango acciaio inox fiorettato con bordo in gomma particolare estetica nella forma stondata, consegnato con pellicola adesiva resistente ai graffi, su richiesta misure particolari.*

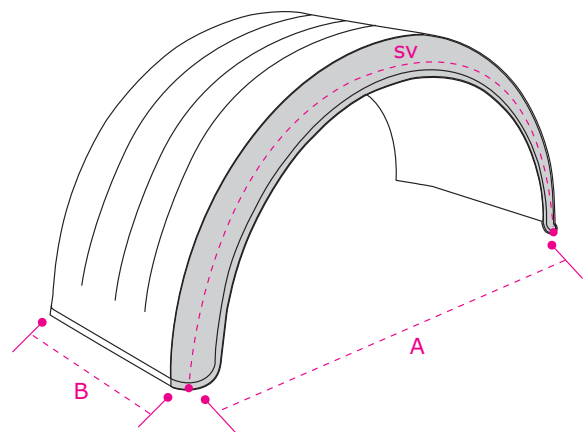

ARTICLE	A	B	SV	KG
IG10002	880	280	1300	3,20
IG10003	880	400	1360	4,50
IG10004	880	450	1360	4,60
IG10007	1000	450	1500	5,30
IG10008	1000	500	1650	6,40

ARTICLE	A	B	SV	KG
IG10005	1000	550	1650	7,30
IG10010	1120	500	1750	7,40
IG10012	1115	600	1800	8,40
IG10013	1115	650	1800	9,50
IG10014	1200	650	1900	9,50

ARTICLE	A	B	SV	KG
IG10006	1200	550	1850	7,90
IG10009	1200	600	1900	8,00
IG10016	1340	450	1900	7,30
IG10015	1340	450	2100	7,70
IG10017	1340	650	2100	10,00



# Mudguards



## Flowered Stainless Steel Half Mudguard with Rubber Edge

*Mezzo Parafango Inox Fiore Bordo Gomma*

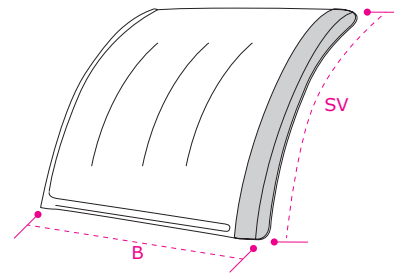

ARTICLE	B	SV	KG
IG20057	500	600	2,30
IG20058	600	600	2,50
IG20059	650	600	2,90

ARTICLE	B	SV	KG
IG20060	500	700	2,50
IG20061	600	700	2,80
IG20062	650	700	3,40

ARTICLE	B	SV	KG
IG20063	500	800	3,30
IG20064	600	800	3,50
IG20065	650	800	3,90

## Flowered Stainless Steel Multi Axle Mudguard with Rubber Edge

*Parafango Doppio Asse Inox Fiore Bordo Gomma*

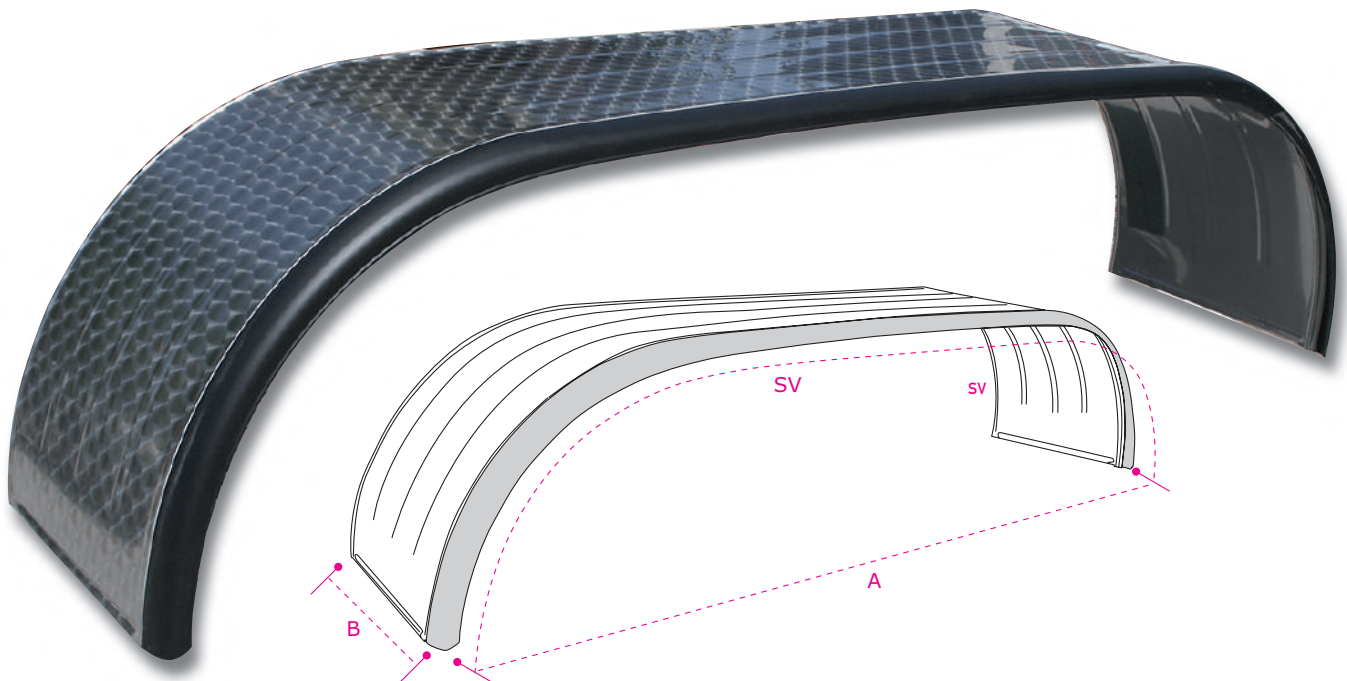

**i** Flowered stainless steel double axle mudguard with a rubber edge, particularly aesthetic with its round shape, delivered with scratch-resistant adhesive film, special sizes on request.  
*Parafango acciaio inox fiorettato bordo gomma doppio asse particolare estetica nella forma stondata, consegnato con pellicola adesiva resistente ai graffi, su richiesta misure particolari.*

ARTICLE	A	B	SV	KG
IG10025	2740	650	3500	18,6
IG10026	3950	650	4780	28,7



## Galvanized Mudguard with Rubber Edge

*Parafango Zinco Gomma*

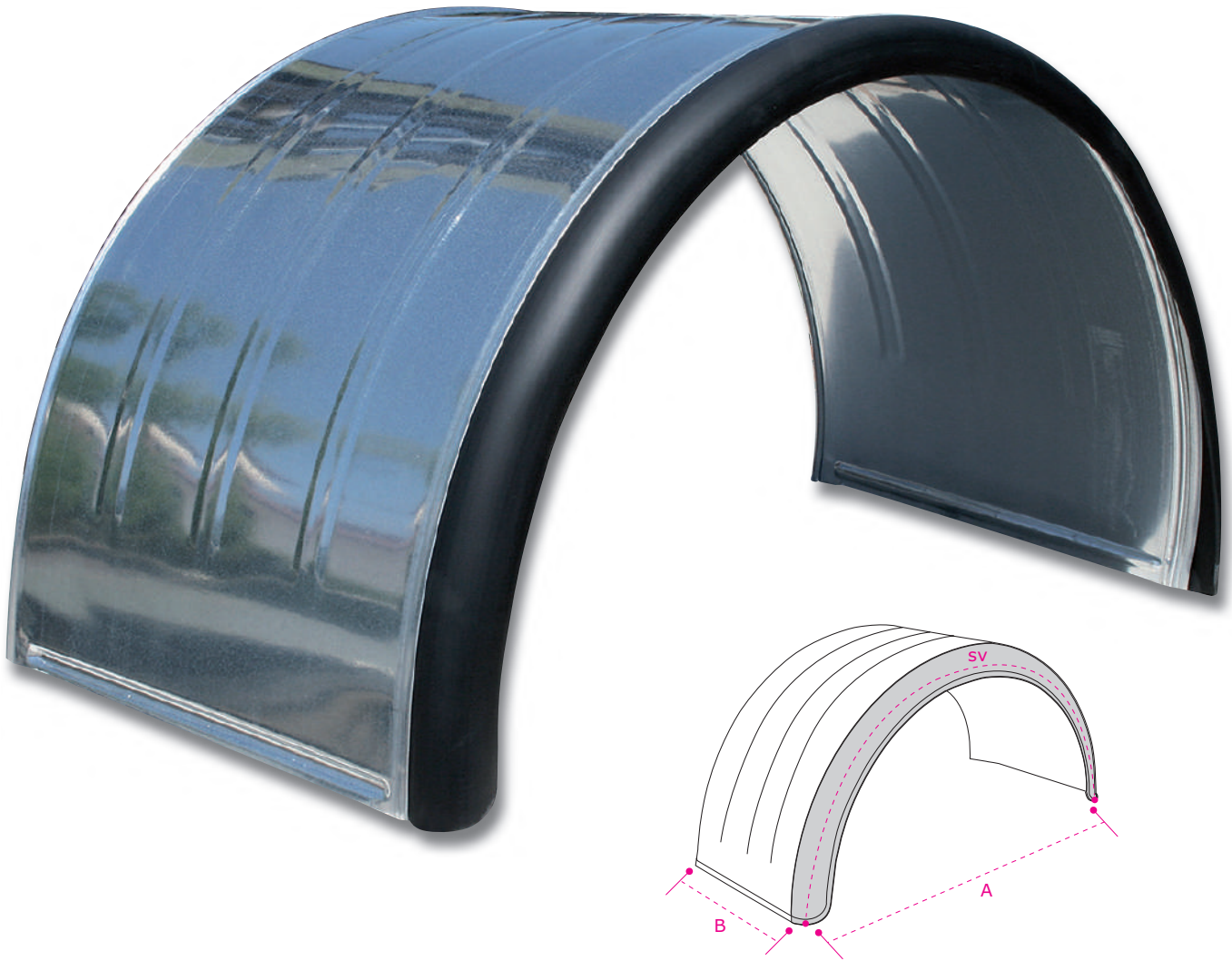

**i** Galvanized mudguard with rubber edge, very flexible, special sizes on request.  
*Parafango zincato bordo in gomma, particolarmente flessibile, misure particolari su richiesta.*

ARTICLE	A	B	SV	KG
P10028	710	150	1000	2,30
P10042	710	350	1000	2,30
P10001	800	220	1300	2,80
P10000	820	240	1250	2,80
P10002	880	280	1300	2,80
P10003	880	400	1350	4,20
P10004	880	450	1350	4,60

ARTICLE	A	B	SV	KG
P10007	1000	450	1500	5,50
P10008	1000	500	1650	6,10
P10009	1000	550	1650	6,60
P10039	1100	550	1650	6,60
P10029	1110	550	1750	6,70
P10010	1150	500	1750	6,90
P10011	1200	550	1850	7,30

ARTICLE	A	B	SV	KG
P10012	1200	600	1900	8,20
P10013	1200	650	1900	8,40
P10014	1260	550	2000	9,50
P10015	1340	450	2100	7,40
P10016	1340	600	2100	10,2
P10017	1340	650	2100	9,10
P10038	1340	700	1900	9,10

# Mudguards



## Galvanized Half Mudguard with Rubber Edge

*Mezzo Parafango Zinco Gomma*

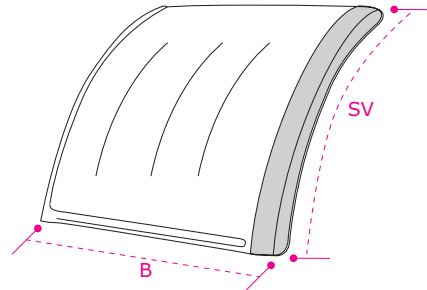
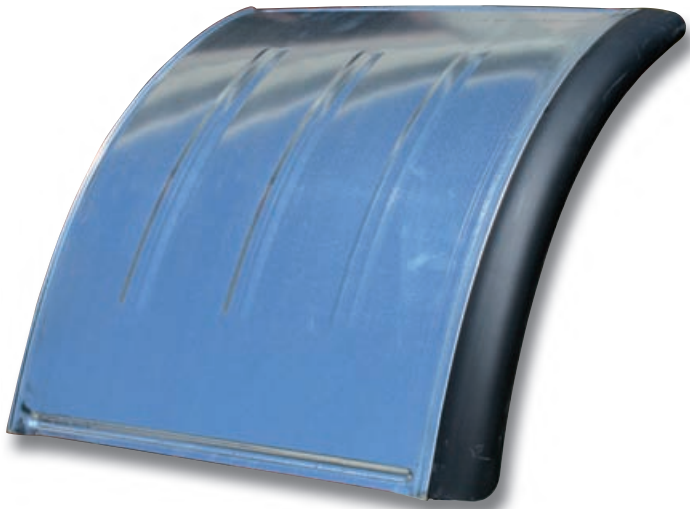

ARTICLE	B	SV	KG
P10060	500	700	2,50
P10061	600	700	2,80
P10063	650	700	3,40

ARTICLE	B	SV	KG
P10064	500	800	3,30
P10065	600	800	3,50
P10066	650	800	3,90

## Galvanized Multi Axle Mudguard with Rubber Edge

*Parafango Doppio Asse Zinco Gomma*

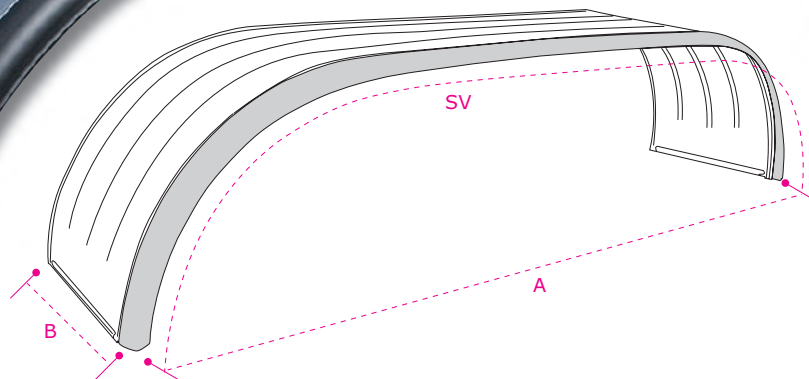
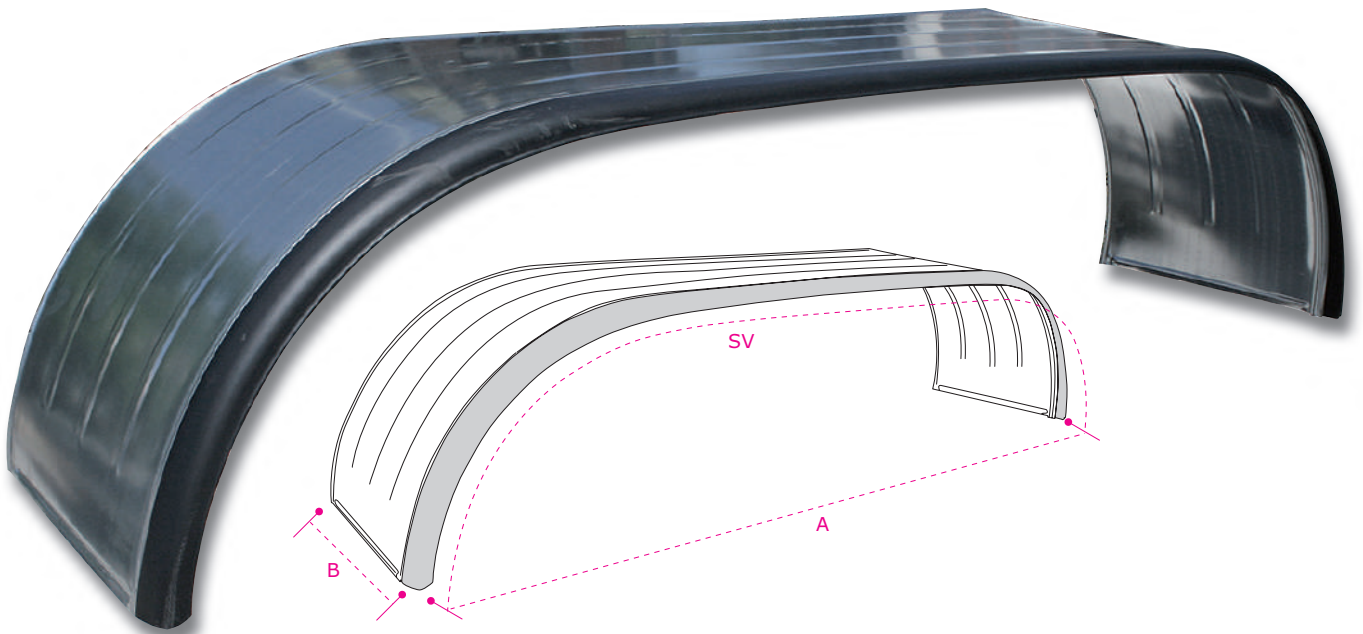

ARTICLE	A	B	SV	KG
P10022	2640	600	3400	17,20
P10023	2640	650	3400	17,60
P10024	2740	600	3500	17,80

ARTICLE	A	B	SV	KG
P10025	2740	650	3500	18,60
P10032	3950	500	4780	25,00
P10026	3950	650	4780	28,70



## Corner Edged Single Axle Mudguard

*Parafango Spigolato Asse Singolo*

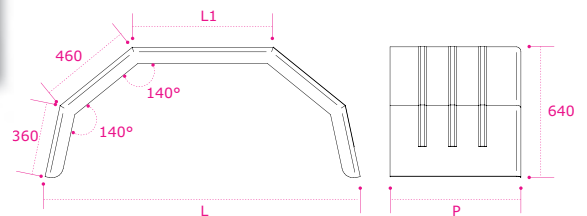
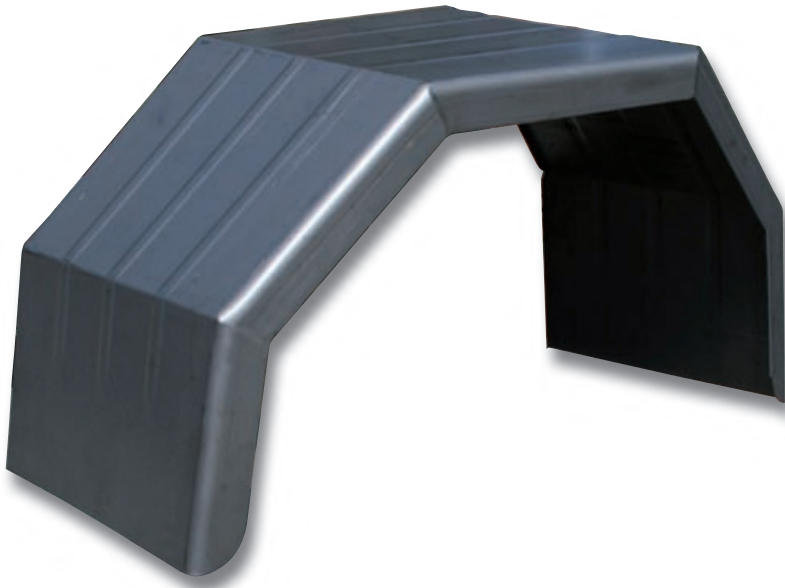

**i** Special sizes on request.  
Su richiesta si realizzano misure personalizzate.

ARTICLE	L	L1	P	SP	KG	
<b>FP22000</b>	1400	520	650	18/10	22,50	30

## Corner Edged Multi Axle Mudguard

*Parafango Spigolato Doppio Asse*

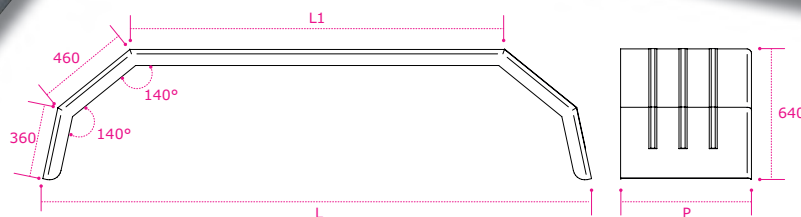
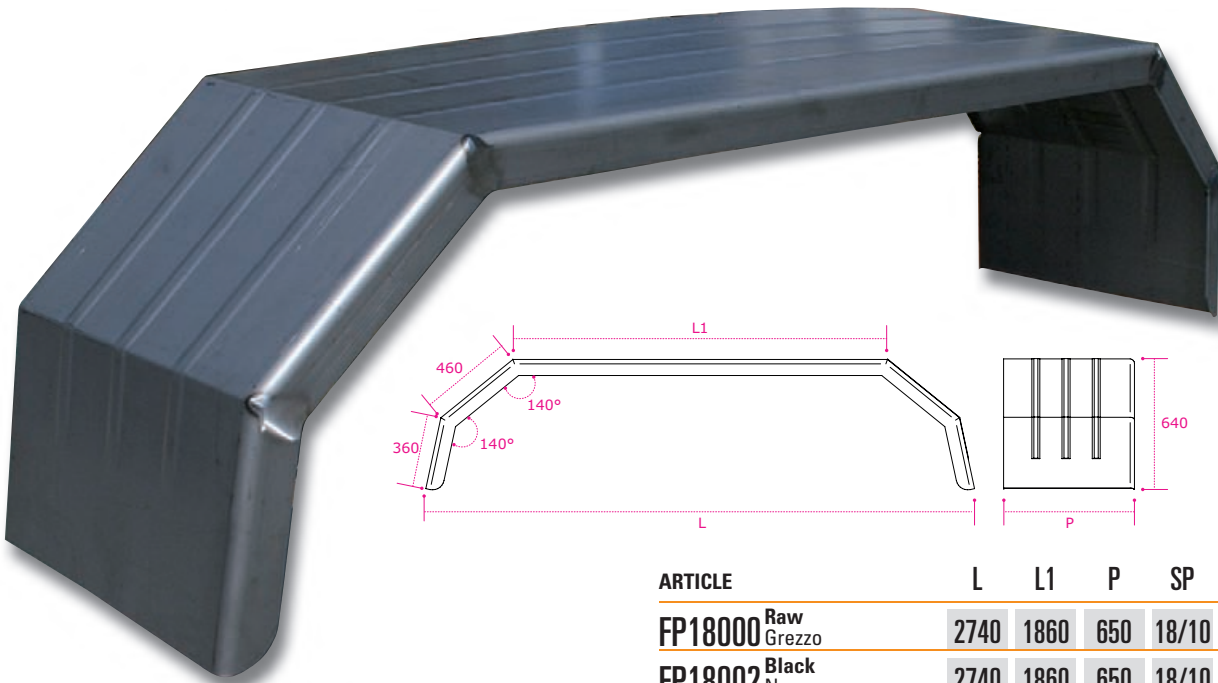

ARTICLE	L	L1	P	SP	KG	
<b>FP18000</b> Raw Grezzo	2740	1860	650	18/10	39,60	15
<b>FP18002</b> Black Nero	2740	1860	650	18/10	39,60	15

**i** Raw steel and black painted mudguard, RAL 7021, edged, double axle for work vehicles, special sizes on request.  
Parafango acciaio grezzo e verniciato nero, RAL 7021, spigolato, doppio asse per mezzi d'opera, su richiesta misure particolari.

# Mudguards



## Alluminum Almond Corner Edged Multi Axle Mudguard

Parafango Spigolato Doppio Asse in Alluminio Mandorlato

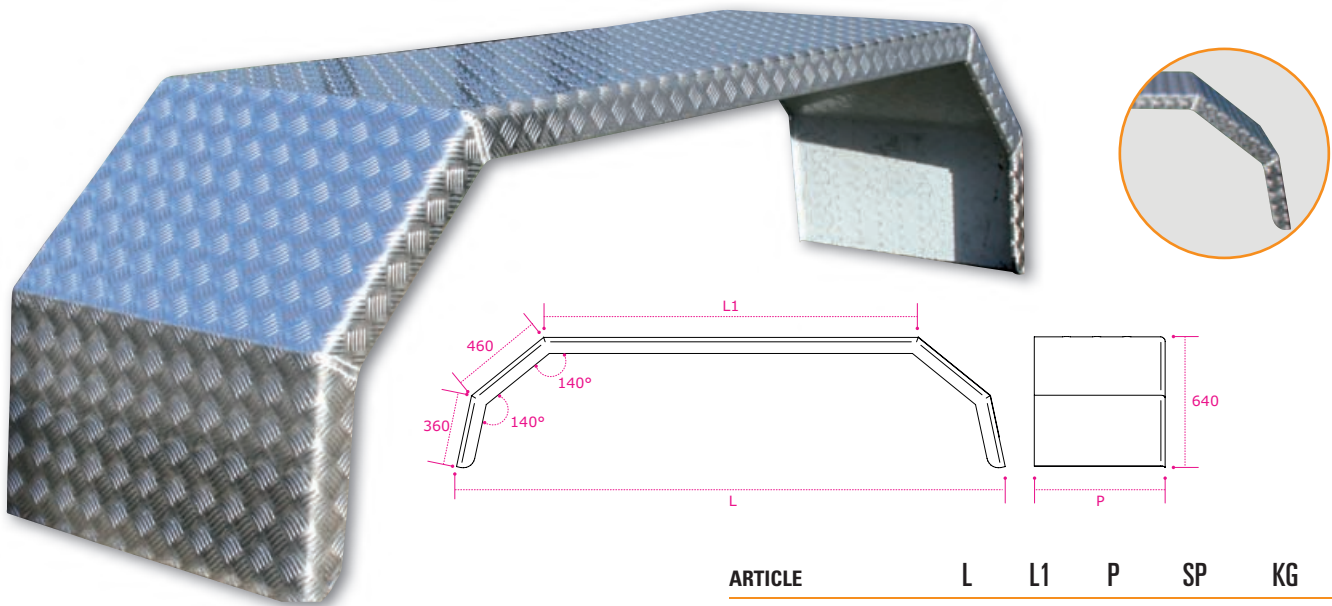

**i** Special sizes on request.  
Su richiesta si realizzano misure personalizzate.

ARTICLE	L	L1	P	SP	KG	
AL18000	2740	1860	650	30/10	22,00	15

## Flowered Stainless Steel Corner Edged Multi Axle Mudguard

Parafango Spigolato Doppio Asse Inox Fiorettato

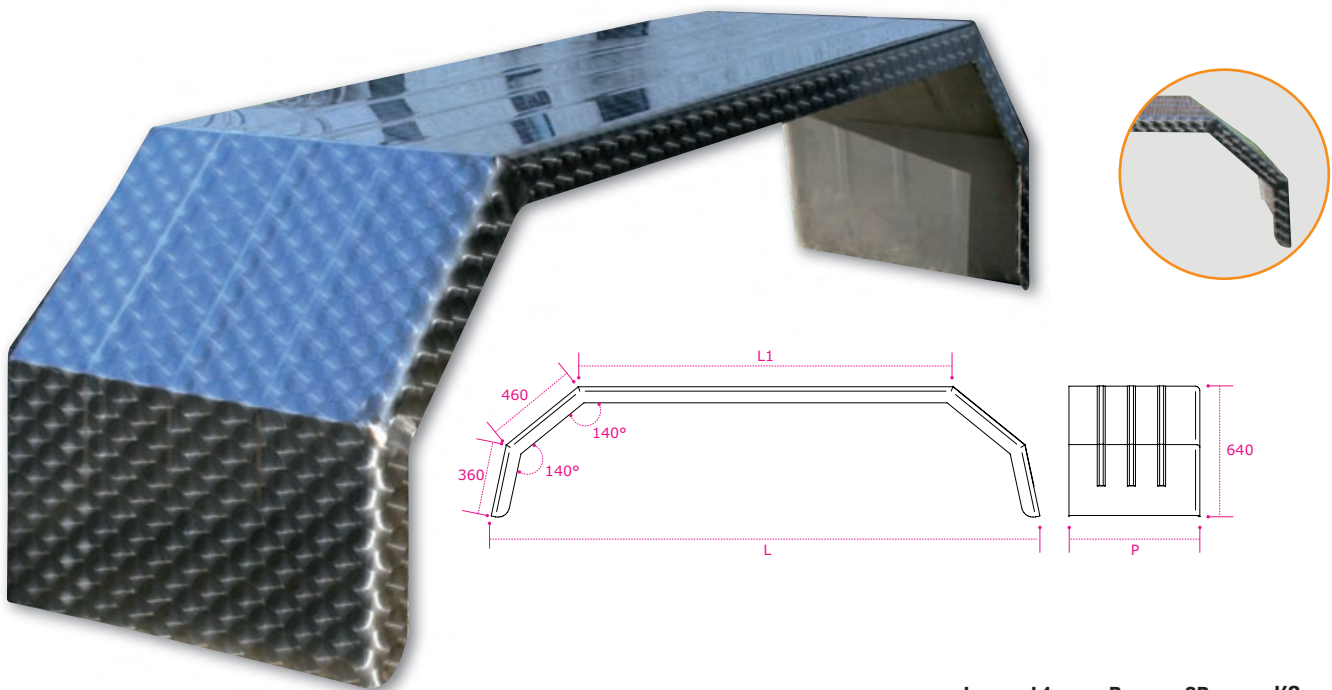

**i** Special sizes on request.  
Su richiesta si realizzano misure personalizzate.

ARTICLE	L	L1	P	SP	KG	
IF18000	2740	1860	650	15/10	30,00	15



## Flowered Steel Mudguard Fixing Ø42

Aletta Supp. Inox Fiore Ø42

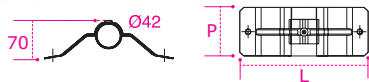

ARTICLE	D	L	P	KG	
Q100108	42	230	80	0,29	1

## Flowered Steel Mudguard Fixing Ø54

Aletta Supp. Inox Fiore Ø54

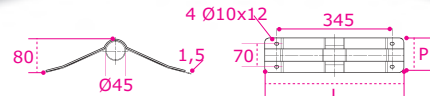

ARTICLE	D	L	P	KG	
Q100107	54	400	105	0,54	1

## Galvanized Mudguard Fixing Ø42

Aletta Supp. Zincata Ø42

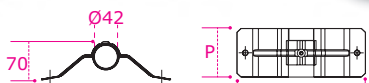

ARTICLE	D	L	P	KG	
Q100106	42	230	80	0,29	1

## Galvanized Mudguard Fixing Ø54

Aletta Supp. Zincata Ø54

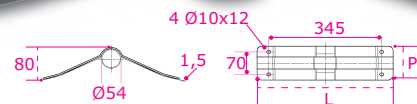

ARTICLE	D	L	P	KG	
P60046	54	400	105	0,54	1

## Raw Steel Mudguard Fixing Ø42

Aletta Supp. Acciaio Grezzo Ø42

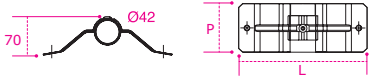

ARTICLE	D	L	P	KG	
Q100105	42	230	80	0,29	1

## Raw Steel Mudguard Fixing Ø54

Aletta Supp. Acciaio Grezzo Ø54

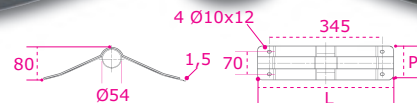

ARTICLE	D	L	P	KG	
P60045	54	400	105	0,54	1

## Screws Kit for Steel Mudguard Fixing

Kit Viti - Alette Acciaio



ARTICLE	D	L	KG	
R70120	8	25	0,16	1

## Screws Kit for PVC Mudguard Fixing

Kit Viti - Alette Pvc



ARTICLE	D	L	KG	
R70121	8	25	0,12	1

## Rivets Kit for PVC Mudguard Fixing

Kit Rivetti - Alette Pvc



ARTICLE	D	L	KG	
R70125	7,8	18	0,12	1

# Mudguards Fixing

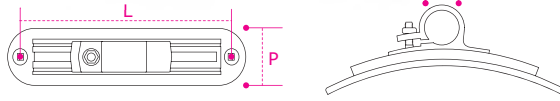

## PVC Adjustable Mudguard Fixing

*Aletta Regolabile Pvc*

ARTICLE	D	L	P	KG	
Q100109	42	260	70	0,28	50
Q100119	48	260	70	0,29	50
Q100110	54	260	70	0,29	50

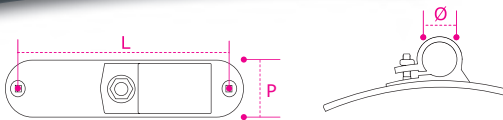

## PVC Not Adjustable Mudguard Fixing

*Aletta Supporto Fisso Pvc*

ARTICLE	D	L	P	KG	
P50042	42	140	50	0,13	100
P50054	54	220	50	0,25	100

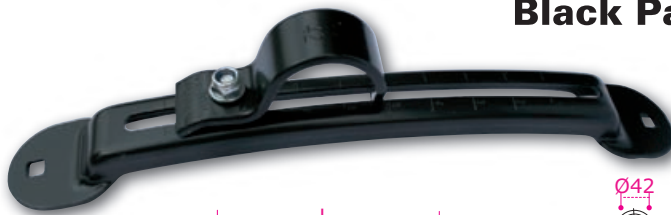

## Black Painted Adjustable Mudguard Fixing

*Aletta Regolabile Verniciata Nero*

ARTICLE	D	L	P	KG	
P600411	42	310	50	0,47	50

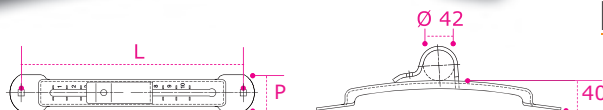

## Galvanized Adjustable Mudguard Fixing

*Aletta Regolabile Zincata*

ARTICLE	D	L	P	KG	
P60041	42	310	50	0,47	50

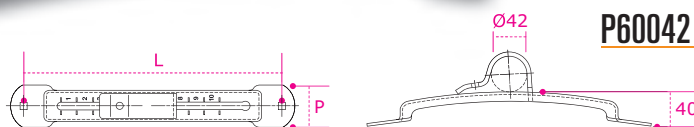

## Stainless Steel Adjustable Mudguard Fixing

*Aletta Regolabile Inox*

ARTICLE	D	L	P	KG	
P60042	42	310	50	0,47	50

# Supports for Mudguards



## Cut 45° Curved Tube Ø42

*Tube Curvo Taglio 45° Ø42*

ARTICLE	D	L	SP	KG	
<b>P60033</b> Raw Grezzo	42	790	2	1,67	100
<b>P60034</b> Galvanized Zincato	42	790	2	1,67	100
<b>P60035</b> Stainless Steel Inox	42	790	2	1,67	100

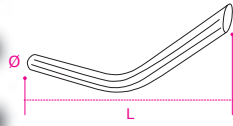

## Cut 45° Curved Tube Ø54

*Tube Curvo Taglio 45° Ø54*

ARTICLE	D	L	SP	KG	
<b>P60030</b> Raw Grezzo	54	790	2	2,15	100
<b>P60031</b> Galvanized Zincato	54	790	2	2,15	100
<b>P60032</b> Stainless Steel Inox	54	790	2	2,15	100

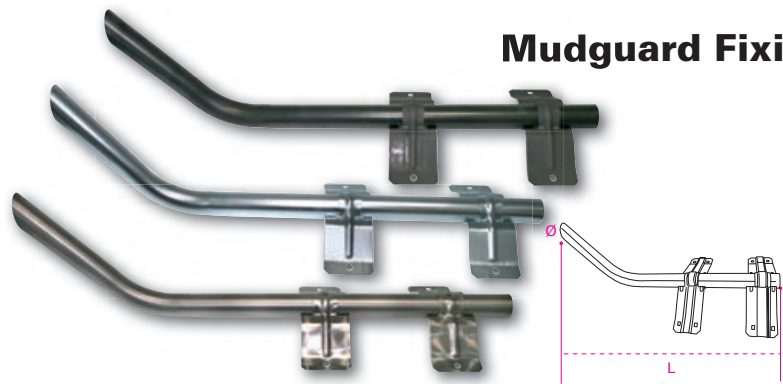
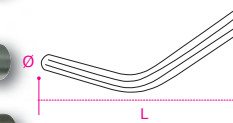

## Mudguard Fixing Kit Cut 45° Curved Tube Ø42

*Staffa Completa Tube Curvo Taglio 45° Ø42*

ARTICLE	D	L	SP	KG	
<b>P600330</b> Raw Grezzo	42	790	2	2,90	100
<b>P600340</b> Galvanized Zincato	42	790	2	2,90	100
<b>P600350</b> Stainless Steel Inox	42	790	2	2,90	100

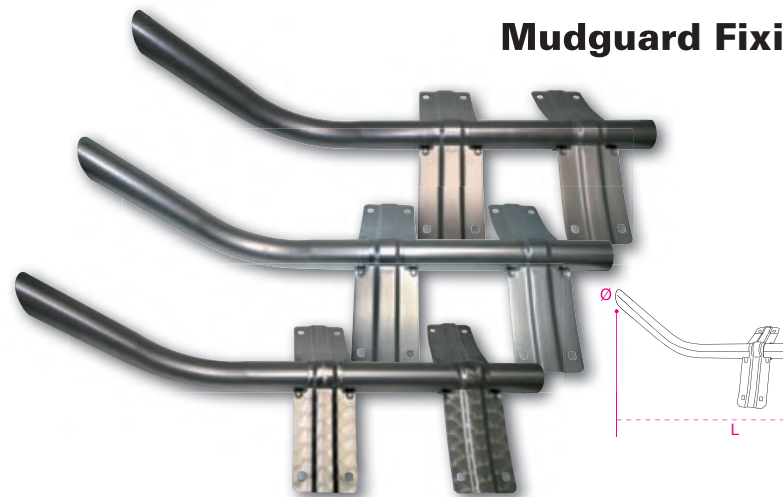
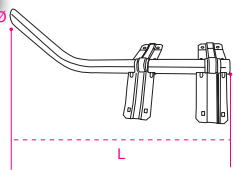

## Mudguard Fixing Kit Cut 45° Curved Tube Ø54

*Staffa Completa Tube Curvo Taglio 45° Ø54*

ARTICLE	D	L	SP	KG	
<b>P600300</b> Raw Grezzo	54	790	2	3,20	100
<b>P600310</b> Galvanized Zincato	54	790	2	3,20	100
<b>P600320</b> Stainless Steel Inox	54	790	2	3,20	100

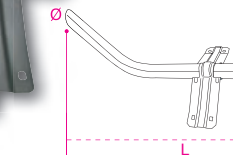

## Reinforced Galvanized Mudguard Support Ø42 - 4 Holes

*Staffa Supporto 4 Fori Zincata Rinforzata Ø42*



ARTICLE	D	L	L1	H1	SP	KG	
<b>Q100132</b>	42	760	85	105	2	1,75	20

**TKcert** RINA UNI EN ISO 15614-1:2012



# Supports for Mudguards

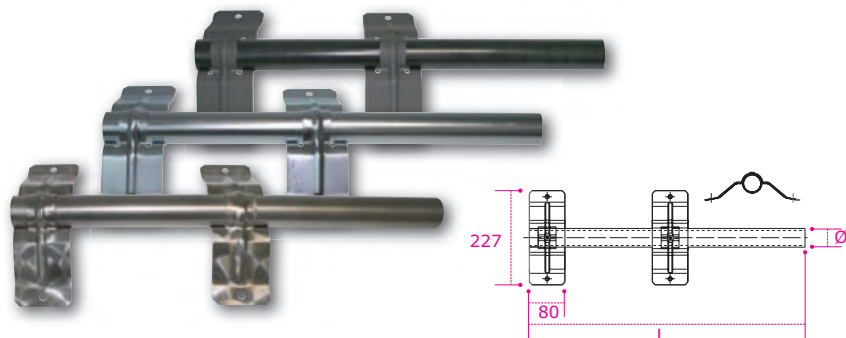

## Mudguard Fixing Kit Ø42

Staffa Completa Ø42

ARTICLE		D	L	SP	KG	
P60010	Raw Grezzo	42	600	2	1,5	100
P60011	Galvanized Zincato	42	600	2	1,5	100
P60012	Flowered SS Inox Fiore	42	600	2	1,5	100

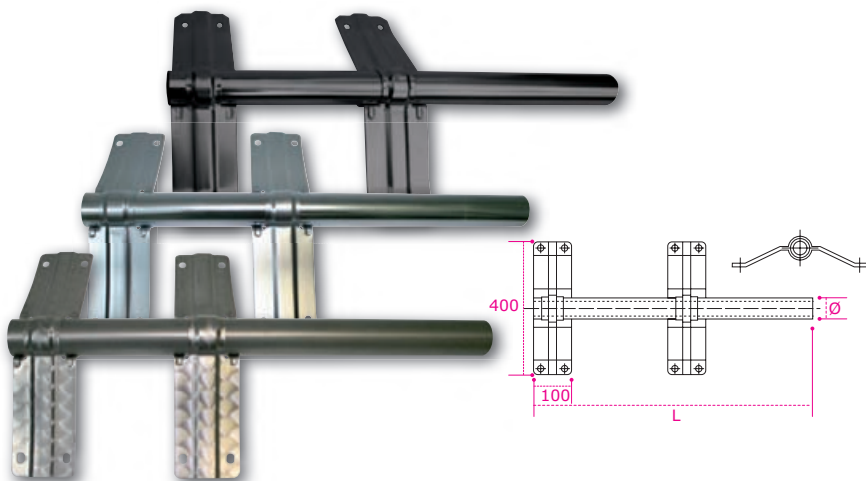

## Mudguard Fixing Kit Ø54

Staffa Completa Ø54

ARTICLE		D	L	SP	KG	
P60020	Raw Grezzo	54	760	2	3,20	100
P60021	Galvanized Zincato	54	760	2	3,20	100
P60023	Flowered SS Inox Fiore	54	760	2	3,20	100

## Galvanized Tube with Adjustable Pvc Support

Staffa Zincata Con Alette Pvc Regolabili

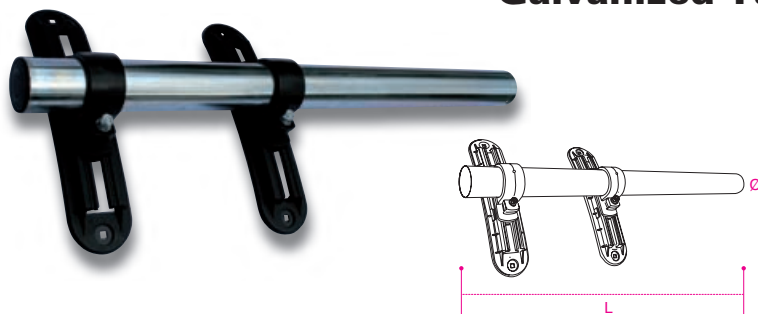

ARTICLE		D	L	SP	KG	
P90026		42	600	2	1,40	1
P90025		54	760	2	1,40	1

## Galvanized Tube with Pvc Support

Staffa Zincata Con Alette Pvc Fisse

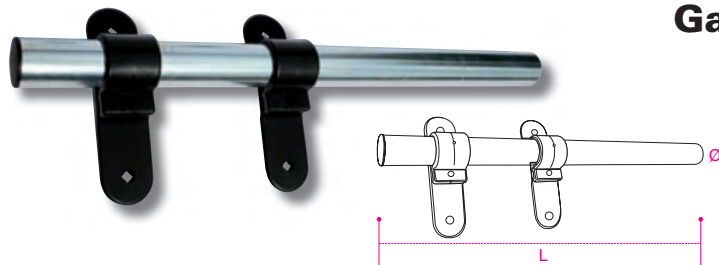

ARTICLE		D	L	SP	KG	
P90028		42	600	2	1,10	1
P90029		48	760	2,7	1,40	1
P90030		54	760	2	1,50	1

## Central Support for Mudguard Double Axle

Supporto Centrale per Parafanghi Doppio Asse

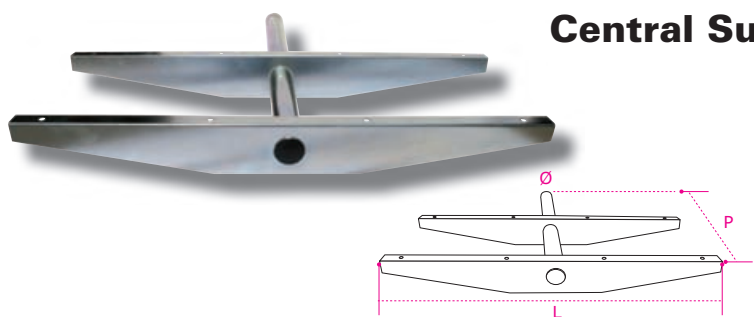

ARTICLE		D	L	P	SP	KG	
P600321	Galvanized Zincato	54	750	970	2	4,60	2
P600322	Stainless Steel Inox	54	750	970	2	4,60	2

# Supports for Mudguards

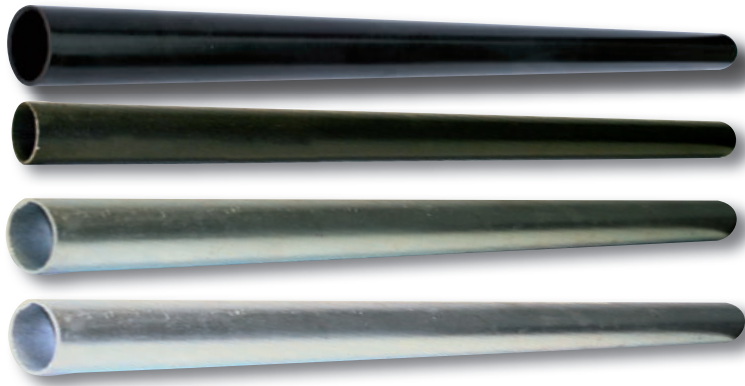

**i** Ø42x2 indicated for industrial or commercial vehicles with a maximum capacity of 80 quintals. Ø42x2.5 indicated for industrial vehicles, tractors and trailers Ø48x2,7 and Ø54x2. TOP RANGE indicated for earthmoving machinery, roll-off tractors and gully clearers.  
 Ø42x2 indicato per Veicoli Commerciali o Industriali con portata max 80q.li. Ø42x2,5 indicato per tutti i Veicoli Industriali, Motrici e Rimorchi. Ø48x2,7 and Ø54x2. TOP GAMMA indicato per Cavacantiere, Scarrabili, Motrici e Autospurghi.



## Straight Tube *Tube Dritto*

ARTICLE		D	L	SP	KG	
Q100096Z	Galvanized Zincato	42	600	2	1,00	100
Q100098G	Raw Grezzo	42	760	2	1,20	100
Q100098	Galvanized Zincato	42	760	2	1,20	100
Q100099	Black Nero	42	760	2	1,20	100
Q100144	Stain. Steel Inox	42	600	2	1,00	100
Q100141	Raw Grezzo	42	800	2,5	1,94	100
Q100142	Black Nero	42	800	2,5	1,94	100
Q100143	Galvanized Zincato	42	800	2,5	1,94	100
Q200099	Black Nero	48	800	2,7	1,60	100
Q200100	Galvanized Zincato	48	800	2,7	1,60	100
Q100100G	Raw Grezzo	54	760	2	1,98	100
Q100100	Galvanized Zincato	54	760	2	1,98	100
Q100097	Stain. Steel Inox	54	760	2	1,98	100
Q100121	Black Nero	54	760	2	1,98	100

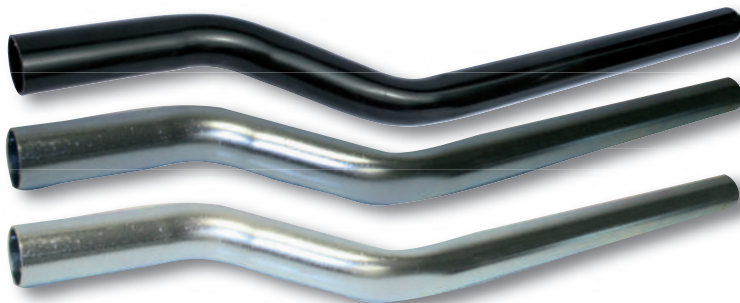

**i** Ø42x2 indicated for industrial or commercial vehicles with a maximum capacity of 80 quintals. Ø42x2.5 indicated for industrial vehicles, tractors and trailers Ø48x2,7 and Ø54x2. TOP RANGE indicated for earthmoving machinery, roll-off tractors and gully clearers.  
 Ø42x2 indicato per Veicoli Commerciali o Industriali con portata max 80q.li. Ø42x2,5 indicato per tutti i Veicoli Industriali, Motrici e Rimorchi. Ø48x2,7 and Ø54x2. TOP GAMMA indicato per Cavacantiere, Scarrabili, Motrici e Autospurghi.



## Curved Tube *Tube Curvo*

ARTICLE		D	L	SP	KG	
M10002	Black Nero	42	760	2	1,42	100
M10013	Stain. Steel Inox	42	760	2	1,42	100
M10006	Galvanized Zincato	42	760	2	1,42	100
M10015	Black Nero	42	800	2,5	1,80	100
M10016	Galvanized Zincato	42	800	2,5	1,80	100
M20003	Black Nero	48	800	2,7	1,95	100
M20006	Galvanized Zincato	48	800	2,7	1,80	100

## Straight Tube For Chassis *Tube Dritto Attacco Chassis*



ARTICLE		D	L	SP	KG	
Q100113	Black Nero	42	760	2	1,60	100
Q100123	Black Nero	42	450	2	1,90	100
Q100127	Stain. Steel Inox	42	760	2	1,90	100
Q100104	Galvanized Zincato	42	760	2	1,60	100

TKcert RINA UNI EN ISO 15614-1:2012

Q100114	Black Nero	42	800	2,5	1,90	100
Q100126	Galvanized Zincato	42	800	2,5	1,90	100

TKcert RINA UNI EN ISO 15614-1:2012

Q200114	Black Nero	48	800	2,7	2,00	100
Q200104	Galvanized Zincato	48	800	2,7	1,90	100

TKcert RINA UNI EN ISO 15614-1:2012

**i** Ø42x2 indicated for industrial or commercial vehicles with a maximum capacity of 80 quintals. Ø42x2.5 indicated for industrial vehicles, tractors and trailers Ø48x2,7 TOP RANGE indicated for earthmoving machinery, roll-off tractors and gully clearers.  
 Ø42x2 indicato per Veicoli Commerciali o Industriali con portata max 80q.li. Ø42x2,5 indicato per tutti i Veicoli Industriali, Motrici e Rimorchi. Ø48x2,7 TOP GAMMA indicato per Cavacantiere, Scarrabili, Motrici e Autospurghi.

# Supports for Mudguards



## Curved Tube for Chassis Standard *Tube Curvo Attacco Chassis Standard*



**42**  
x2.5  
LIGHT

ARTICLE		D	L	SP	KG	
M10004	Black Nero	42	760	2	1,70	100
M10008	Galvanized Zincato	42	760	2	1,70	100
Q100128	Stain. Steel Inox	42	760	2	3,15	100

TKcert RINA UNI EN ISO 15614-1:2012

**42**  
x2.5  
STD

M10014	Galvanized Zincato	42	800	2,5	2,05	100
M10009	Black Nero	42	800	2,5	2,05	100

TKcert RINA UNI EN ISO 15614-1:2012

**48**  
x2.7  
TOP

Q20004	Black Nero	48	800	2,7	3,15	100
Q20008	Galvanized Zincato	48	800	2,7	3,15	100

TKcert RINA UNI EN ISO 15614-1:2012

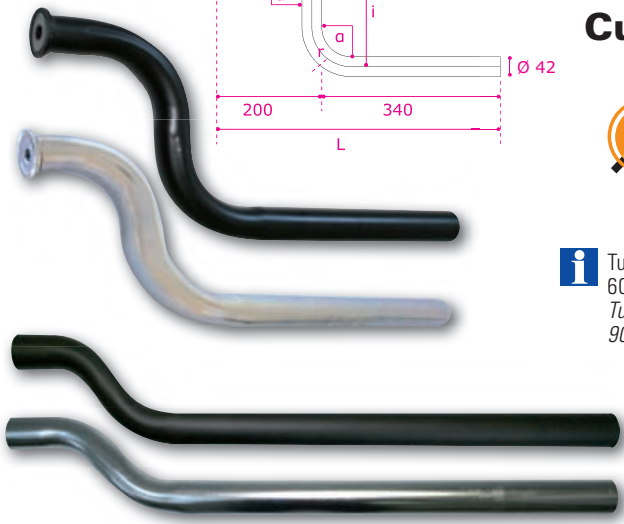
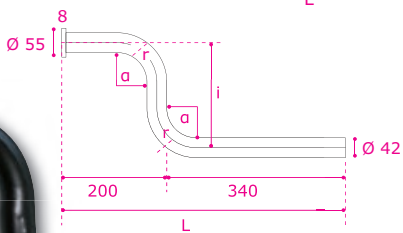

## Curved Tube For Chassis *Tube Curvo Attacco Chassis*

**42**  
x2.5  
STD

ARTICLE		D	L	i	αr	SP	KG	
M10020	Black Nero	42	540	200	90°r 60	2,5	1,40	1
M10021	Galvanized Zincato	42	540	200	90°r 60	2,5	1,40	1

TKcert RINA UNI EN ISO 15614-1:2012

**i** Tube for trailers and semi-trailers, ex Viberti model, double tight "S" curves, 90° fold angle and 60 radius diameter fold, inter-axis distance 200mm, indicated for P50014 and P50015.  
*Tube per rimorchi e semirimorchi, mod. ex Viberti, doppia curva stretta ad "S" angolo curvatura 90° e diametro raggio curvatura 60, distanza interasse 200 mm indicato per P50014 e P50015.*

## Curved Tube Straight Radius *Tube Curvo a Raggiatura Stretta*

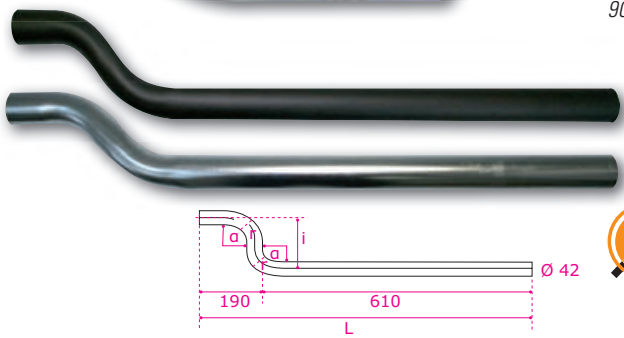

**42**  
x2.5  
STD

ARTICLE		D	L	i	αr	SP	KG	
Q100135	Black Nero	42	800	80	90°r 60	2,5	1,95	1
Q100153	Galvanized Zincato	42	800	80	90°r 60	2,5	1,95	1

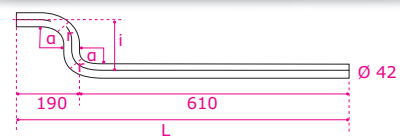

## Curved Tube Straight Radius for Chassis *Tube Curvo Raggio Stretto Attacco Chassis*

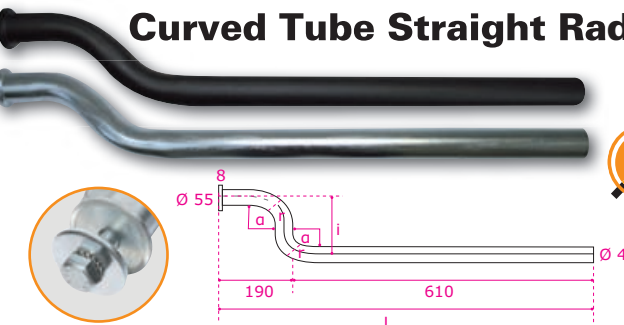

**42**  
x2.5  
STD

ARTICLE		D	L	i	SP	αr	KG	
Q100152	Black Nero	42	800	80	2,5	90°r 60	2,10	1
Q100154	Galvanized Zincato	42	800	80	2,5	90°r 60	2,10	1

TKcert RINA UNI EN ISO 15614-1:2012

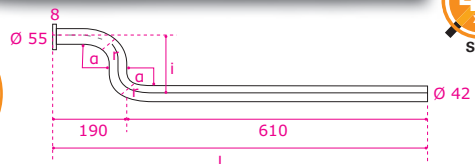

## Straight Tube Triangular Connection Ø42 *Tube Dritto Attacco Triangolo Ø42*

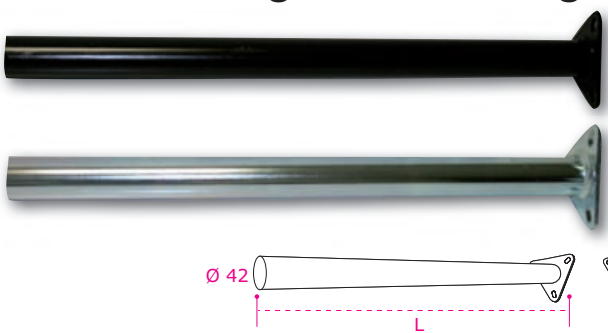

**42**  
x2  
LIGHT

ARTICLE		D	L	SP	KG	
Q100134	Black Nero	42	480	2	1,66	100
Q100115	Black Nero	42	750	2	2,16	100
Q100118	Galvanized Zincato	42	480	2	1,38	100
Q100120	Galvanized Zincato	42	600	2	1,66	100
Q100117	Galvanized Zincato	42	750	2	2,16	100

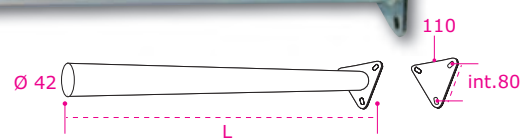

TKcert RINA UNI EN ISO 15614-1:2012

# Supports for Mudguards



## Black Painted Central Support Double Mudguard - Small

Supporto Centrale Doppio Parafango STRETTO Verniciato Nero

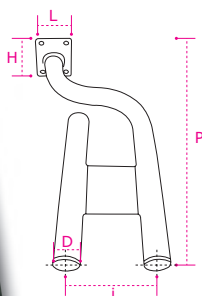

ARTICLE	L	H	P	D	SP	i	αr	KG	
Q100148	85	105	520	42	2	120	90°r 60	2,35	1

TKcert RINA UNI EN ISO 15614-1:2012



**i** Central support double mudguard for trailers and semi-trailers, double tight "S" curves, 90° fold angle and 60 radius diameter fold, inter-axis distance 120mm, exclusively indicated for attaching to 60041 and P60041.

Supporto centrale doppio parafango per rimorchi e semirimorchi, doppia curva stretta ad "S" angolo curvatura 90° e diametro raggio curvatura 60, distanza interasse 120 mm indicato esclusivamente per alette P60041 e P60041.

## Black Painted Central Support Double Mudguard - Medium

Supporto Centrale Doppio Parafango MEDIO Verniciato Nero

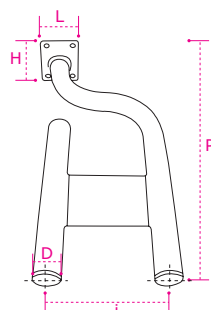

ARTICLE	L	H	P	D	SP	i	αr	KG	
Q100149	85	105	520	42	2	180	90°r 60	2,60	1

TKcert RINA UNI EN ISO 15614-1:2012



**i** Central support double mudguard for trailers and semi-trailer, double tights "S" curves, 90° fold angle and 60 radius diameter fold, inter-axis distance 120mm, exclusively indicated for attaching P60041 and P60041.

Supporto centrale doppio parafango per rimorchi e semirimorchi, doppia curva stretta ad "S" angolo curvatura 90° e diametro raggio curvatura 60, distanza interasse 120 mm indicato esclusivamente per alette P60041 e P60041.

## Black Painted Central Support Double Mudguard - Large

Supporto Centrale Doppio Parafango LARGO Verniciato Nero

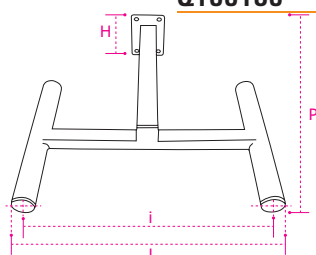

ARTICLE	L	H	P	D	SP	i	KG	
Q100150	122	85	520	42	2	440	3,05	1

TKcert RINA UNI EN ISO 15614-1:2012



**i** Large central support double mudguard for tractors, trailers and semi-trailers, inter-axis distance 440mm indicated for attaching with a diameter of 42.

Supporto centrale doppio parafango largo per motrici, rimorchi e semirimorchi, distanza interasse 440 mm indicato per tutti i modelli di alette diam. 42.

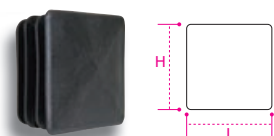

### PVC Caps Tappo Quadro PVC

ARTICLE	L	H	KG	
110318202N	40	40	0,08	1



### PVC Cap for Tubes Tappo per Tubi

ARTICLE	D	P	KG	
P60004	25	15	0,004	50
P60014	42	25	0,015	50

ARTICLE	D	P	KG	
P60024/1	48	29	0,022	50
P60024	54	26	0,025	50

# Fixing Brackets and Supports

## Galvanized Standard Fixing Bracket 4 Holes Ø42

*Calice Standard 4 Fori Ø42 Zincato*

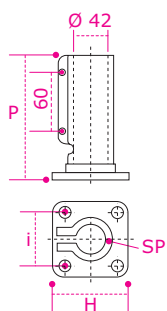

ARTICLE	D	H	P	SP	i	KG	
P60051	42	85	130	1,5	60	0,62	50



## Galvanized Ø42 Fixing Bracket With Triangular Plate

*Calice Ø42 Zincato Piastra Triangolo*

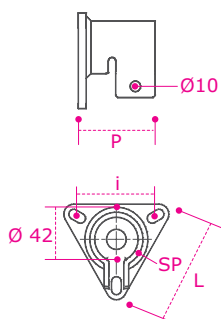
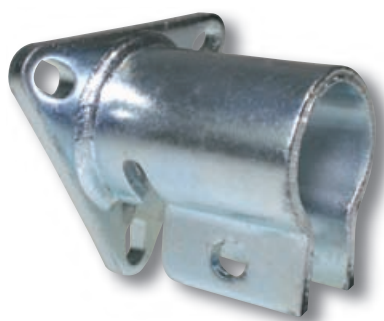

ARTICLE	D	L	P	SP	i	KG	
P600511	42	105	80	7	80	0,85	50

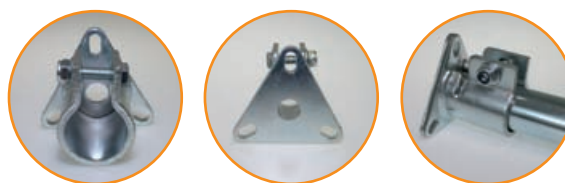

## Galvanized Fixing Bracket Ø42 Plate with Bolt

*Calice Ø42 Zincato Piastra con Bullone*

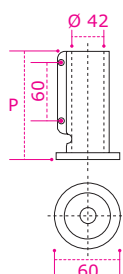

ARTICLE	D	P	PA	i	KG	
P600512	42	135	16x2	60	0,62	50

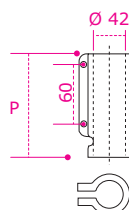

## Raw Ø42 Fixing Bracket to Welded

*Calice Ø42 Grezzo a Saldare*

ARTICLE	D	P	KG	
P60055/2	42	130	0,39	50

# Fixing Brackets and Supports

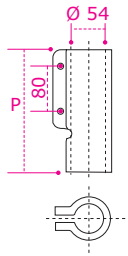
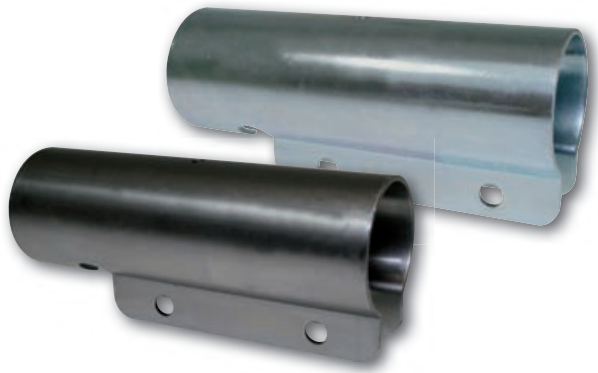

## Standard Fixing Bracket Ø54

*Calice Standard Ø 54*

ARTICLE	D	P	SP	KG	
<b>P60059</b> Galvanized Zincato	54	190	2,5	0,70	50
<b>P60058</b> Raw Grezzo	54	190	2,5	0,70	50

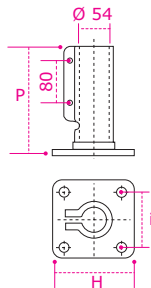
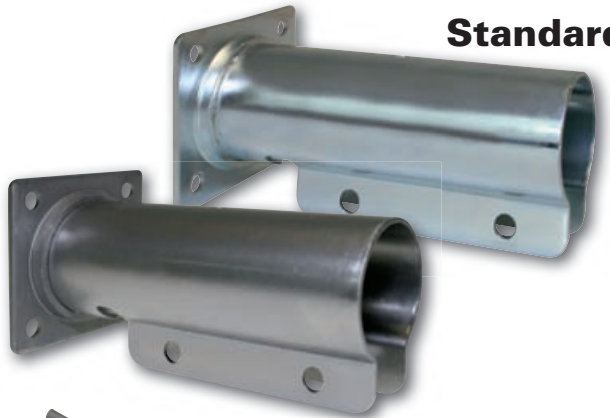

## Standard Fixing Bracket with Plate 4 Holes Ø54

*Calice Standard con Piastra 4 Fori Ø 54*

ARTICLE	D	H	P	SP	i	KG	
<b>P60056</b> Galvanized Zincato	54	90	190	2,5	65	0,86	50
<b>P60054</b> Raw Grezzo	54	90	190	2,5	65	0,86	50

**TKcert** RINA UNI EN ISO 15614-1:2012

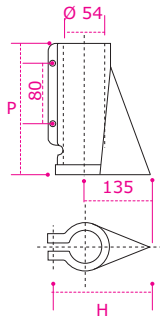

## Raw Reinforced Fixing Bracket Ø54 to Welded

*Calice Grezzo Rinforzato Ø54 a Saldare*

ARTICLE	D	H	P	SP	KG	
<b>P60055/1</b>	54	130	190	2,5	0,92	50

**TKcert** RINA UNI EN ISO 15614-1:2012

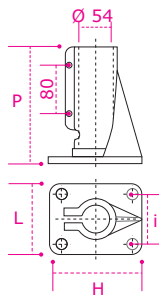
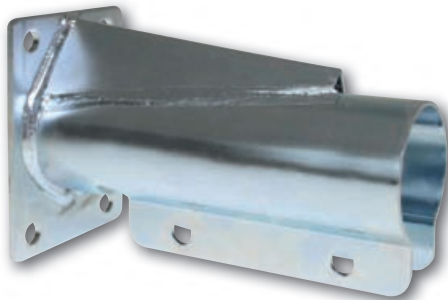

## Galvanized Reinforced Fixing Bracket Ø54 with Plate

*Calice Rinforzato Ø 54 con Piastra e Fazzoletto Zincato*

ARTICLE	D	L	H	P	SP	i	KG	
<b>P600531</b>	54	85	120	190	2,5	95/55	1,15	50

**TKcert** RINA UNI EN ISO 15614-1:2012

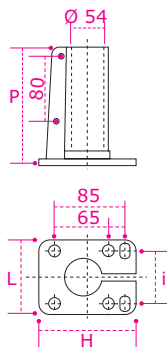

## Galvanized Reinforced Fixing Bracket Ø54

*Calice Ø54 Rinforzato Zincato*

ARTICLE	D	L	H	P	i	SP	KG	
<b>P60052</b>	54	90	120	140	65	2	0,96	50

# Fixing Brackets and Supports



## Stainless Steel Fixing Bracket 4 Holes AISI 304

Calice Standard 4 Fori Ø54 Inox AISI 304

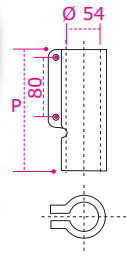

ARTICLE	D	P	SP	KG	
<b>IN60058</b> Standard Liscio	54	190	2	0,70	50
<b>IF60058</b> Flowered Fiorettato	54	190	2	0,70	50

TKcertRINA UNI EN ISO 15614-1:2012

## Stainless Steel Fixing Bracket with Plate 4 Holes AISI 304

Calice con Piastra 4 Fori Ø54 Inox AISI 304

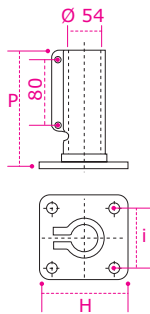

ARTICLE	D	H	P	SP	i	KG	
<b>IN60054</b> Standard Liscio	54	90	190	2	65	0,86	50
<b>IF60054</b> Flowered Fiorettato	54	90	190	2	65	0,86	50

TKcertRINA UNI EN ISO 15614-1:2012

## Stainless Steel Reinforced Fixing Bracket 4 Holes AISI 304 to Welded

Calice Rinforzato 4 Fori Ø54 Inox AISI 304 a Saldare

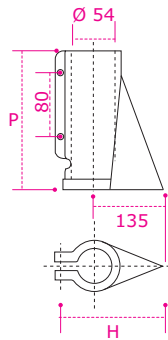
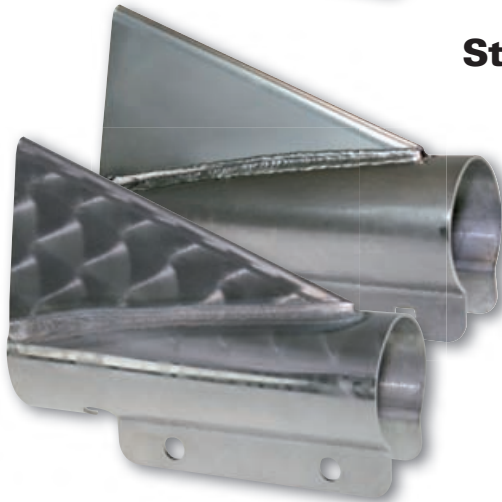

ARTICLE	D	H	P	SP	KG	
<b>IN600551</b> Standard Liscio	54	130	190	2	0,92	50
<b>IF600551</b> Flowered Fiorettato	54	130	190	2	0,92	50

TKcertRINA UNI EN ISO 15614-1:2012

## Stainless Steel Reinforced Fixing Bracket with Plate 4 Holes AISI 304

Calice rinforzato 4 Fori con Piastra Ø54 Inox AISI 304

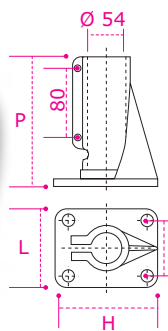

ARTICLE	D	L	H	P	SP	i	KG	
<b>IN600531</b> Standard Liscio	54	85	120	190	2	95/55	1,15	50
<b>IF600531</b> Flowered Fiorettato	54	85	120	190	2	95/55	1,15	50

TKcertRINA UNI EN ISO 15614-1:2012



# Wheel Chocks

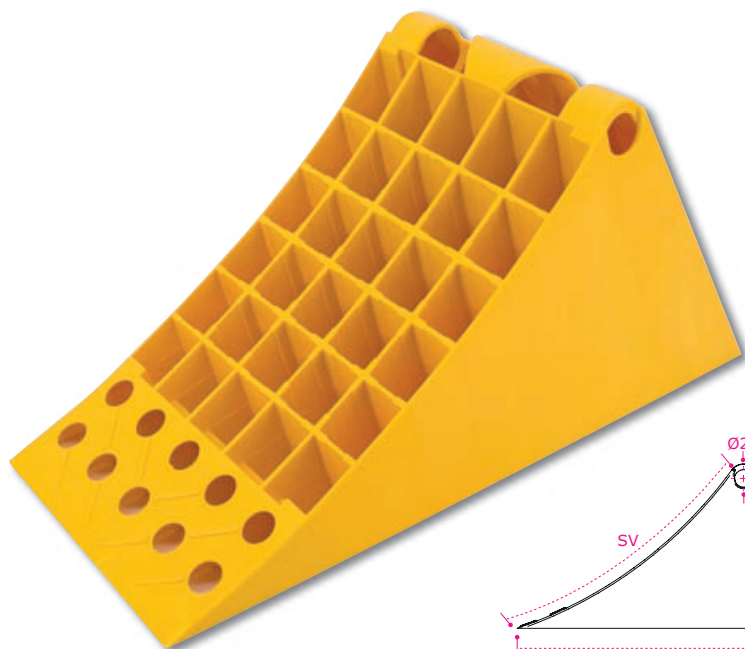

## Homologated Wheel Chock - Big

*Calzatoia Omologata Grande*

ARTICLE	L	H	P	SV	KG	
R23111	470	235	200	400	1,34	50

In compliance with the legislation DIN 76051-53 vehicle parking devices.  
 Conforme alla Normativa DIN 76051-53 dispositivi di stazionamento veicoli.

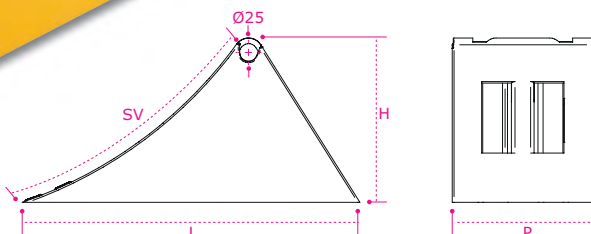

## Homologated Wheel Chock - Medium

*Calzatoia Omologata Media*

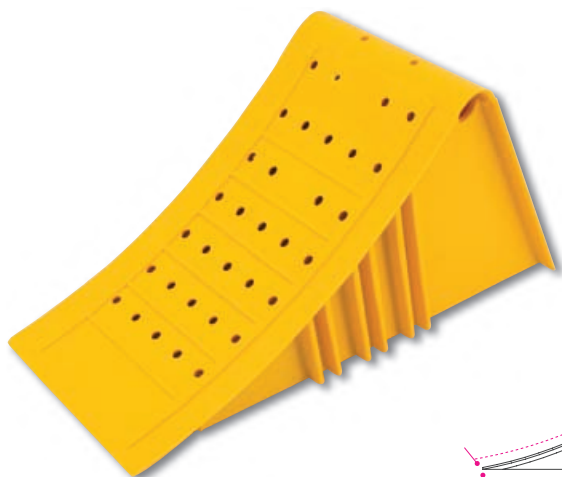

ARTICLE	L	H	P	SV	KG	
R23112	380	190	160	320	0,80	50

In compliance with the legislation DIN 76051-53 vehicle parking devices.  
 Conforme alla Normativa DIN 76051-53 dispositivi di stazionamento veicoli.

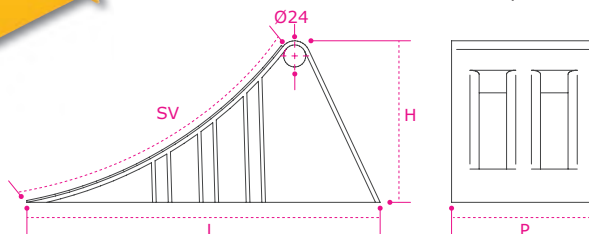

## Medium and Big Wheel Chock Support

*Supporto Calzatoia Media e Grande*

ARTICLE	D	L	PA	KG	
R24111	20	210	16x2	0,36	50

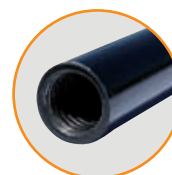



# Fireboxes



## PVC Firebox 6 Kg Slim *Porta Estintore 6 Kg Pvc Slim*

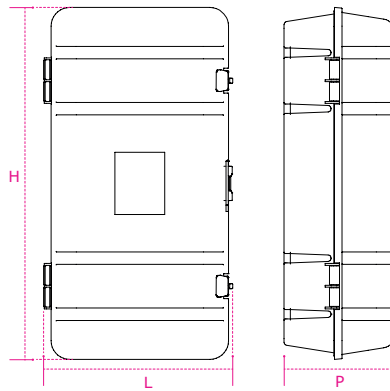

ARTICLE	L	H	P	KG	
<b>P</b> C10RO	290	560	180	2,90	1
<b>P</b> C10RON	290	560	180	2,90	1



**i** Thermoplastic firebox made by injection, 6kg Slim, practical for mounting on the base, galvanized steel plate with holes and ratchet straps, able to contain extinguishers of various dimensions of diameter. Possibility to customise in the central part.  
*Portaestintore Termoplastico ad Iniezione, 6 Kg. Slim, pratico per il montaggio sul fondo, piastra in acciaio zincato preforata con cinghia a cricchetto, per contenere estintori di varie misure di diametro. Possibilità di personalizzazione sulla parte centrale.*



## PVC Firebox 6 Kg *Porta Estintore 6 Kg Pvc*

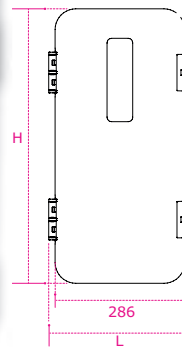

ARTICLE	L	H	P	KG	
<b>P</b> C11RO	305	630	260	5,70	1



**i** Thermoplastic firebox made by injection, 6kg Slim, practical for mounting on the base, galvanized steel plate with holes and ratchet straps, able to contain extinguishers of various dimension of diameter. External inspection window with the possibility to customise the central part.  
*Portaestintore Termoplastico ad Iniezione, 6 Kg. Slim, pratico per il montaggio sul fondo, piastra in acciaio zincato preforata con cinghia a cricchetto, per contenere estintori di varie misure di diametro. Finestra esterna di ispezione e possibilità di personalizzazione sulla parte centrale.*



## PVC Firebox Made by Rotomolding System 9-12 Kg

*Porta Estintore ad Iniezione 9-12 Kg Pvc*

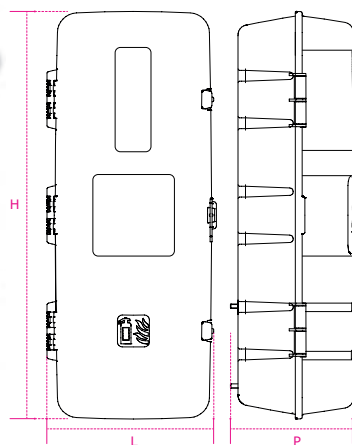

ARTICLE	L	H	P	KG	
<b>P</b> C15RO	290	760	210	4,35	1



**i** Thermoplastic firebox made by injection, 9-12kg. Slim, practical for mounting on the base, galvanized steel plate with holes and ratchet straps, to contain extinguishers of various dimensions of diameter. External inspection window with the possibility to customise the central part.  
*Portaestintore Termoplastico ad Iniezione, 9-12 Kg. Slim, pratico per il montaggio sul fondo, piastra in acciaio zincato preforata con cinghia a cricchetto, per contenere estintori di varie misure di diametro. Finestra esterna di ispezione e possibilità di personalizzazione sulla parte centrale.*



## PVC Firebox 6 Kg with Top Loading

Porta Estintore 6 Kg Pvc con Carico dall'Alto

ARTICLE	L	H	P	KG	
<b>C19R0</b>	265	655	290	3,10	1

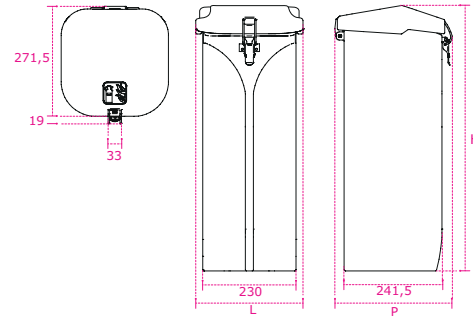

## Galvanized Adjustable Support Kit for Firebox C19R0

Kit Supporto Zincato Orientabile per Portaestintore C19R0

ARTICLE	L	H	P	P1	SP	KG	
<b>C19R01</b>	47	250	448	360	30/10	5,40	1

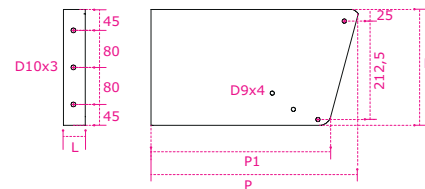
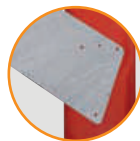

## Galvanized Horizontal Support Kit for Firebox C19R0

Kit Supporto Zincato Fissaggio Orizzontale per Portaestintore C19R0

ARTICLE	L	H	P	SP	KG	
<b>C19R02</b>	53	40	318	40/10	1,60	1

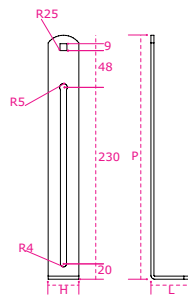

## Extractable Firebox with Horizontal Support 6-9-12 Kg

Portaestintore Estraibile 6-9-12 Kg con Supporto Orizzontale

ARTICLE	L	H	P	KG	
<b>C16R0</b>	317	305	705	11,80	1

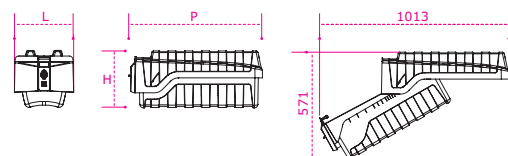
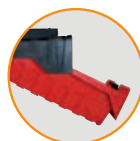

# Fireboxes



## Stainless Steel Closed Firebox 6-9 Kg

Porta Estintore Chiuso 6-9 Kg in Acciaio Inox

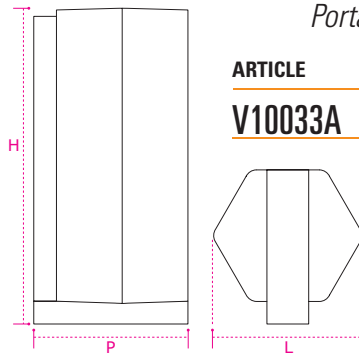

ARTICLE	L	H	P	SP	KG	
V10033A	200	410	200	10/10	2,80	1

**i** Fire extinguisher not included.  
Estintore non incluso.

## Metal Support for Fire Extinguisher 6 Kg

Porta Estintore 6 Kg in Metallo



ARTICLE	L	H	P	KG	
C14RO	210	550	215	7,20	1

**i** Fire extinguisher not included.  
Estintore non incluso.

## Black Painted Metal Support for Fire Extinguisher 3-4 Kg

Porta Estintore 3-4 Kg in Metallo Verniciato Nero



ARTICLE	L	H	P	KG	
C18RO	163	400	170	1,15	1

**i** Fire extinguisher not included.  
Estintore non incluso.

## Fire Extinguisher 12 Kg

Estintore 12 Kg



ARTICLE	D	H	KG	
ESTINT12	190	610	17,65	1

## Fire Extinguisher 9 Kg

Estintore 9 Kg



ARTICLE	D	H	KG	
ESTINT9	165	600	13,00	1

## Fire Extinguisher 6 Kg

Estintore 6 Kg



ARTICLE	D	H	KG	
ESTINT6	155	500	9,50	1

## Fire Extinguisher 4 Kg

Estintore 4 Kg



ARTICLE	D	H	KG	
ESTINT4	155	470	9,00	1

## Fire Extinguisher 2 Kg

Estintore 2 Kg



ARTICLE	D	H	KG	
ESTINT2	105	380	4,10	1

**i** ALL FIRE EXTINGUISHER: Duration 18 years. Production date and batch stamped in the metal. Taking charge and commissioning of the fire extinguisher must be carried out by an authorized and specialized person. Six-monthly review. Regulation 9994-1.

TUTTI GLI ESTINTORI: Durata 18 anni. Data e lotto di produzione stampigliata nel metallo. Presa in carico e messa in servizio dell'estintore deve essere effettuata da soggetto autorizzato e specializzato. Revisione semestrale. Normativa 9994-1.

# Water Tank

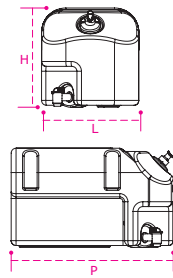

## Polyethylene Water Tank

Tanica Polietilene

ARTICLE	L	H	P	KG	
<b>V40010</b> 25 Liters 25 Litri	300	306	500	2,50	50
<b>V40011</b> 40 Liters 40 Litri	360	360	495	3,00	30
<b>P V40010P</b>	300	306	500	2,50	50
<b>P V40011P</b>	360	360	495	3,00	30
<b>H6000</b>	Cliché for print Clichè per stampa				

**i** Recyclable polyethylene water tank 25 and 40 liters, available in black, with anti-crushing attaching point, soap dispenser supplied separately. Possibility to customise. *Tanica in polietilene riciclabile, capacità 25 e 40 litri, disponibile nei colori nero e neutro, con punti di fissaggio antischiacciamento, con portasapone fornito separatamente. Possibilità di personalizzazione.*

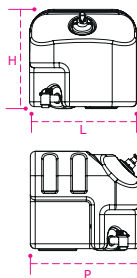

## Polyethylene Water Tank 18 Lt.

Tanica Polietilene 18 Lt.

ARTICLE	L	H	P	KG	
<b>V40009</b>	340	300	300	1,09	50
<b>P V40009P</b>	340	300	300	1,09	50
<b>H6000</b>	Cliché for print Clichè per stampa				

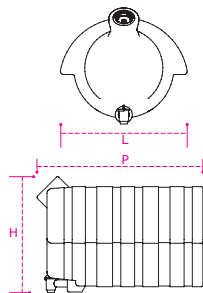

## Black PVC Water Tank Tanica In Pvc Nera

ARTICLE	L	H	P	KG	
<b>V20010</b> 30 Liters 30 Litri	390	350	500	2,80	8
<b>V2001050</b> 50 Liters 50 Litri	473	422	533	3,80	1
<b>P V20010P</b>	390	350	500	2,80	1
<b>P V2001050P</b>	473	422	533	3,80	1

**i** Recyclable polyethylene water tank 30 and 50 liters, available in black and white, with anti-crushing attaching point, soap dispenser supplied separately. Possibility to customise. *Tanica in polietilene riciclabile, capacità 30 e 50 litri, disponibile nei colori nero e bianco, con punti di fissaggio antischiacciamento, con portasapone fornito separatamente. Possibilità di personalizzazione.*

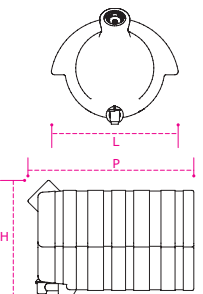

## White PVC Water Tank Tanica In Pvc Bianca

ARTICLE	L	H	P	KG	
<b>V20011</b> 30 Liters 30 Litri	390	350	500	2,80	8
<b>V2001150</b> 50 Liters 50 Litri	473	422	533	3,80	1
<b>P V20011P</b>	390	350	500	2,80	8
<b>P V2001150P</b>	473	422	533	3,80	1

**i** Recyclable polyethylene water tank 30 and 50 liters, available in black and white, with anti-crushing attaching point, soap dispenser supplied separately. Possibility to customise. *Tanica in polietilene riciclabile, capacità 30 e 50 litri, disponibile nei colori nero e bianco, con punti di fissaggio antischiacciamento, con portasapone fornito separatamente. Possibilità di personalizzazione.*

# Water Tank Original with Supports



## Plastic Water Tank 25 Lt. with Galvanized Support

*Tanica Acqua 25 Lt. con Supporto Zincato*



**ORIGINAL**



ARTICLE	L	H	P	KG		
T962/Z	225	450	600	5,60	1	40

TKcertRINA UNI EN ISO 15614-1:2012

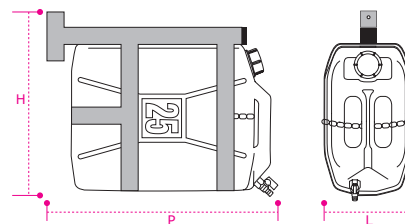

## Plastic Water Tank 10 Lt. with Galvanized Support

*Tanica Acqua 10 Lt. con Supporto Zincato*

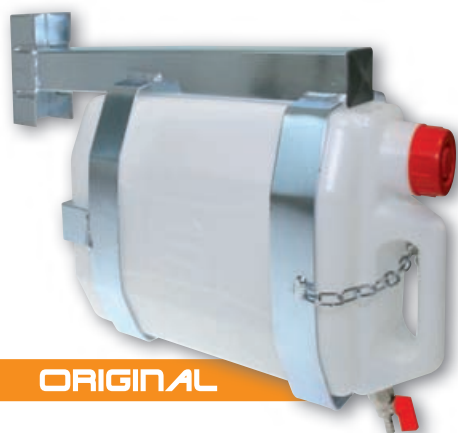

**ORIGINAL**



ARTICLE	L	H	P	KG		
T966/Z	175	380	480	4,20	1	50

TKcertRINA UNI EN ISO 15614-1:2012

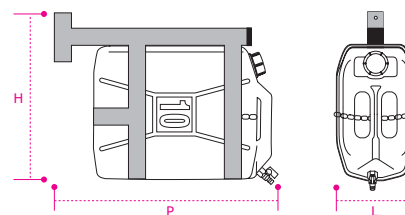

### COMPONENTS "ORIGINAL":

#### T962/Z

Plastic Water Tank 25 Lt. with Galvanized Support  
*Tanica Acqua 25 Lt. con Supporto Zincato*

#### T966/Z

Plastic Water Tank 10 Lt. with Galvanized Support  
*Tanica Acqua 10 Lt. con Supporto Zincato*

#### 111P

Anti-theft Cap for Water Tank with Double Keys  
*Tappo Antifurto per Tanica Acqua con Doppia Chiave*

#### T998S

Kit Soap Dipenser with Antibacterial  
Soap 250 ml. Vertical Bracket  
*Kit Portasapone con Sapone Antibatterico 250 ml. Staffa Verticale*

#### R70127

Rubber Pipe with Wrappers  
*Tubo Cristallo con Fascetta Bifilare per Rubinetto 1/4 Ø11*

## FULLOPTIONAL NEW MODEL



# Water Tank Tractor with Supports



## Plastic Water Tank 25 Lt. with Galvanized Support and Fixing Feet

*Tanica Acqua 25 Lt. con Supporto Zincato e 4 Piedini*



**TRACTOR**

ARTICLE	L	H	P	iL	iP	KG		
<b>T973Z</b>	225	410	490	215	275	4,85	1	32

TKcertRINA UNI EN ISO 15614-1:2012

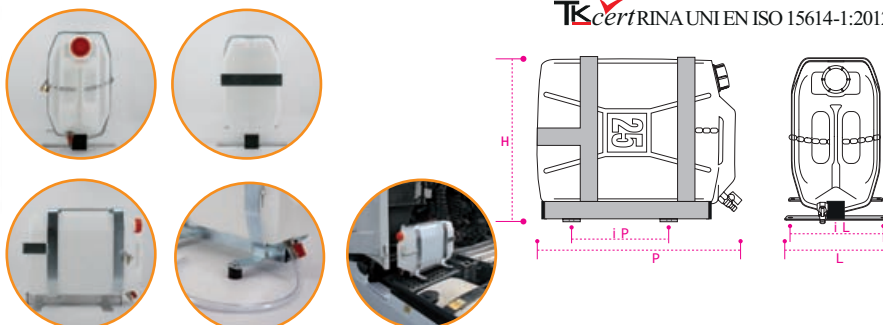

## Plastic Water Tank 10 Lt. with Galvanized Support and Fixing Feet

*Tanica Acqua 10 Lt. con Supporto Zincato e 4 Piedini*



**TRACTOR**

ARTICLE	L	H	P	iL	iP	KG		
<b>T974Z</b>	200	300	350	175	200	3,10	1	50

TKcertRINA UNI EN ISO 15614-1:2012

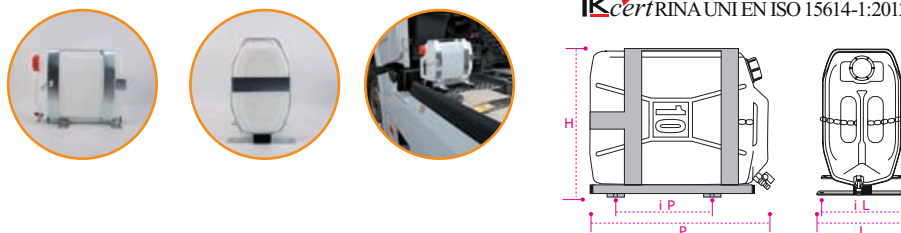

### COMPONENTS "TRACTOR":

#### **T973Z**

Plastic Water Tank 25 Lt. with Galvanized Support and Fixing Feet  
*Tanica Acqua 25 Lt. con Supporto Zincato e 4 Piedini*

#### **T974Z**

Plastic Water Tank 10 Lt. with Galvanized Support and Fixing Feet  
*Tanica Acqua 10 Lt. con Supporto Zincato e 4 Piedini*

#### **111P**

Anti-theft Cap for Water Tank with Double Keys  
*Tappo Antifurto per Tanica Acqua con Doppia Chiave*

#### **T998S**

Kit Soap Dipenser with Antibacterial  
Soap 250 ml. Vertical Bracket  
*Kit Portasapone con Sapone Antibatterico 250 ml. Staffa Verticale*

#### **R70126**

Shock Absorbers Kit  
*Kit Ammortizzatori con Viti TGE 8x16*

#### **R70127**

Rubber Pipe with Wrappers  
*Tubeo Cristallo con Fascetta Bifilare per Rubinetto 1/4 Ø11*

## FULLOPTIONAL NEW MODEL



# Water Tank Lateral with Supports



## Plastic Water Tank 10 Lt. with Galvanized Support and Lateral Fixing

*Tanica Acqua 10 Lt. con Supporto Zincato e Attacco Laterale*



**LATERAL**

ARTICLE	L	H	P	i H	i P	KG		
<b>T979Z</b>	190	285	350	235	200	3,90	1	50

TKcert RINA UNI EN ISO 15614-1:2012

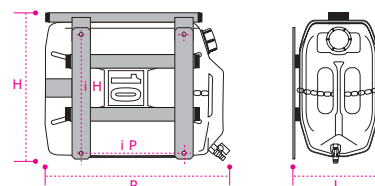

## Plastic Water Tank 10 Lt. with Galvanized Support for Iveco S-Way

*Tanica Acqua 10 Lt. con Supporto Zincato per Iveco S-Way*



**ORIGINAL**



ARTICLE	L	H	P	KG		
<b>T986Z</b>	165	315	350	3,10	1	40

TKcert RINA UNI EN ISO 15614-1:2012

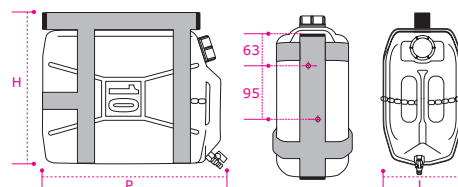

### COMPONENTS "LATERAL" - "ORIGINAL":

#### T979Z

Plastic Water Tank 10 Lt. with Galvanized Support and Lateral Fixing  
*Tanica Acqua 10 Lt. con Supporto Zincato ed Attacco Laterale*

#### T986Z

Plastic Water Tank 10 Lt. with Galvanized Support for Iveco S-Way  
*Tanica Acqua 10 Lt. con Supporto Zincato per Iveco S-Way*

#### 111P

Anti-theft Cap for Water Tank with Double Keys  
*Tappo Antifurto per Tanica Acqua con Doppia Chiave*

#### T998S

Kit Soap Dipenser with Antibacterial  
Soap 250 ml. Vertical Bracket  
*Kit Portasapone con Sapone Antibatterico 250 ml. Staffa Verticale*

#### R70126

Shock Absorbers Kit  
*Kit Ammortizzatori con Viti TGE 8x16*

#### R70127

Rubber Pipe with Wrappers  
*Tubo Cristallo con Fascetta Bifilare per Rubinetto 1/4 Ø11*

## FULLOPTIONAL NEW MODEL



# Water Tank Vertical with Supports



**VERTICAL**

## Plastic Water Tank 10 Lt. with Vertical Galvanized Support

*Tanica Acqua 10 Lt. con Supporto Zincato Verticale*

ARTICLE	L	H	P	KG		
T967Z	175	355	290	2,60	1	50

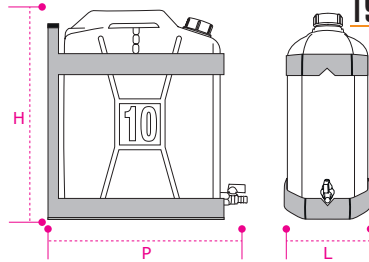

TKcert RINA UNI EN ISO 15614-1:2012



## Plastic Water Tank 25 Lt. with Vertical Galvanized Support

*Tanica Acqua 25 Lt. con Supporto Zincato Verticale*

ARTICLE	L	H	P	KG		
T964Z	225	490	420	4,30	1	32



**VERTICAL**

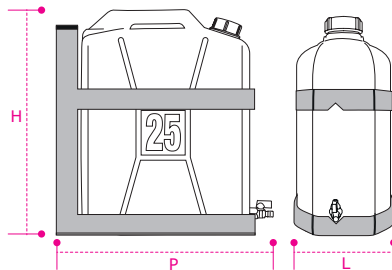

TKcert RINA UNI EN ISO 15614-1:2012

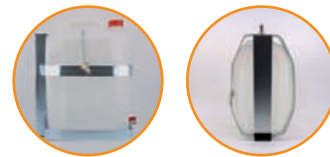

## Plastic Water Tank 25 Lt. with Vertical Galvanized Support

*Tanica Acqua 25 Lt. con Supporto Zincato Verticale*

ARTICLE	L	H	P	KG		
T965Z	225	490	580	5,60	1	24



**VERTICAL**

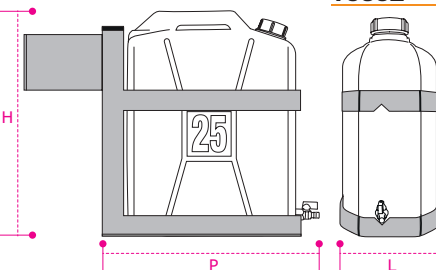

TKcert RINA UNI EN ISO 15614-1:2012

**FULL  
OPTIONAL**

**NEW MODEL**

### COMPONENTS "VERTICAL":

#### T967Z

Plastic Water Tank 10 Lt. with Vertical Galvanized Support  
*Tanica Acqua 10 Lt. con Supporto Zincato Verticale*

#### T964Z - T965Z

Plastic Water Tank 25 Lt. with Vertical Galvanized Support  
*Tanica Acqua 25 Lt. con Supporto Zincato Verticale*

#### 111P

Anti-theft Cap for Water Tank with Double Keys  
*Tappo Antifurto per Tanica Acqua con Doppia Chiave*

#### T998S

Kit Soap Dipenser with Antibacterial Soap 250 ml. Horizontal Bracket  
*Kit Portasapone con Sapone*

Antibatterico 250 ml. Staffa Orizzontale

#### R70126

Shock Absorbers Kit  
*Kit Ammortizzatori con Viti TGE 8x16*

#### R70127

Rubber Pipe with Wrappers  
*Tubo Cristallo con Fascetta Bifilare per Rubinetto 1/4 Ø11*



TRUCK



# Water Tank Curved with Supports



## Plastic Water Tank 10 Lt. with Orizontal Galvanized Curved Left Support

*Tanica Acqua 10 Lt. con Supporto Orizzontale Curvato Sinistro Lato Guida*

**CURVED**

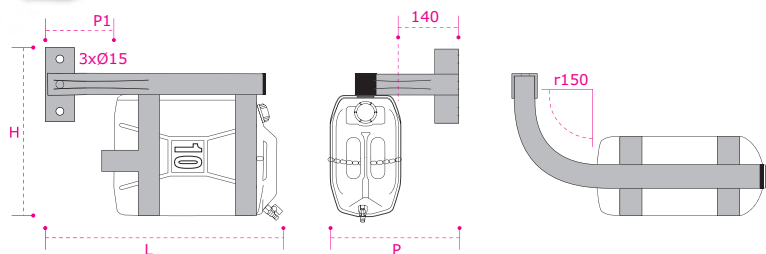
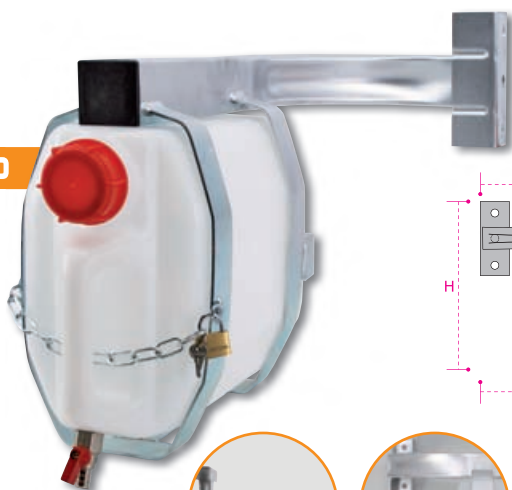

ARTICLE	L	H	P	P1	KG		
<b>T985Z</b>	560	360	310	180	4,20	1	24

TKcert RINA UNI EN ISO 15614-1:2012

## Plastic Water Tank 25 Lt. with Vertical Galvanized Curved Support

*Tanica Acqua 25 Lt. con Supporto Curvato Zincato Verticale*

**CURVED**

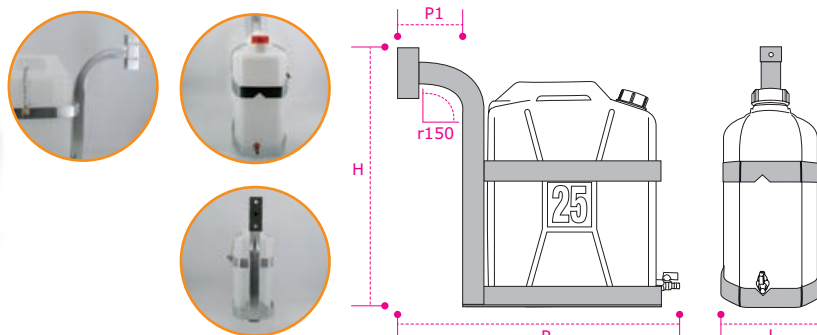

ARTICLE	L	H	P	P1	KG		
<b>T982Z</b>	225	580	600	210	5,70	1	24

TKcert RINA UNI EN ISO 15614-1:2012

### COMPONENTS "CURVED":

#### **T985Z**

Plastic Water Tank 10 Lt. with Orizontal Galvanized Curved Left Support  
*Tanica Acqua 10 Lt. con Supporto Orizzontale Curvato Sinistro Lato Guida*

#### **T982Z**

Plastic Water Tank 25 Lt. with Vertical Galvanized Curved Support  
*Tanica Acqua 25 Lt. con Supporto Curvato Zincato Verticale*

#### **111P**

Anti-theft Cap for Water Tank with Double Keys  
*Tappo Antifurto per Tanica Acqua con Doppia Chiave*

#### **T998S**

Kit Soap Dipenser with Antibacterial Soap 250 ml. Orizontal Bracket  
*Kit Portasapone con Sapone Antibatterico 250 ml. Staffa Orizzontale*

#### **R70126**

Shock Absorbers Kit  
*Kit Ammortizzatori con Viti TGE 8x16*

#### **R70127**

Rubber Pipe with Wrappers  
*Tubo Cristallo con Fascetta Bifilare per Rubinetto 1/4 Ø11*

## FULLOPTIONAL NEW MODEL



# Water Tanks with Faucet



## Plastic Water Tank 10 Lt. with Faucet

*Tanica Nuda 10 Lt. con Rubinetto*



ARTICLE	L	H	P	KG		
T969	156	245	370	0,57	1	60

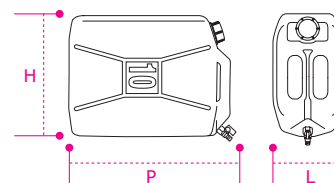

## Plastic Water Tank 15 Lt. with Faucet

*Tanica Nuda 15 Lt. con Rubinetto*



ARTICLE	L	H	P	KG		
T984	176	286	421	1,43	1	60

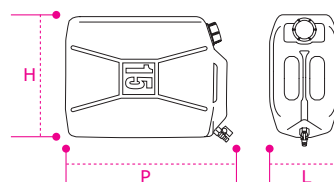

## Plastic Water Tank 20 Lt. with Faucet

*Tanica 20 Lt. Nuda con Rubinetto*



ARTICLE	L	H	P	KG		
T972	190	315	440	0,89	1	60

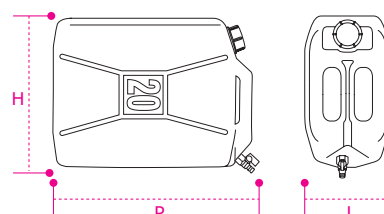

## Plastic Water Tank 25 Lt. with Faucet

*Tanica Nuda 25 Lt. con Rubinetto*



ARTICLE	L	H	P	KG		
T961	215	340	480	1,20	1	60

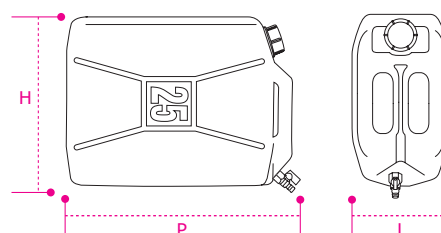

# Vertical Water Tanks with Faucet



## Vertical Plastic Water Tank 10 Lt. with Faucet

*Tanica Verticale 10 Lt. Nuda con Rubinetto*

ARTICLE	L	H	P	KG		
T970	156	360	285	0,57	1	60

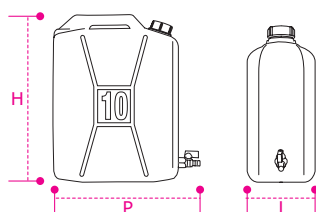

## Vertical Plastic Water Tank 15 Lt. with Faucet

*Tanica Verticale 15 Lt. Nuda con Rubinetto*

ARTICLE	L	H	P	KG		
T983	176	416	331	1,43	1	60

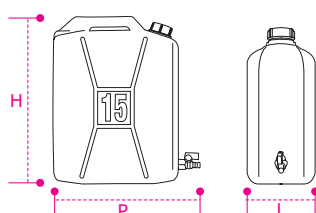

## Vertical Plastic Water Tank 20 Lt. with Faucet

*Tanica Verticale 20 Lt. Nuda con Rubinetto*

ARTICLE	L	H	P	KG		
T971	190	440	360	0,89	1	60

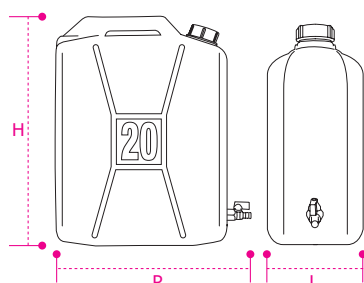

## Vertical Plastic Water Tank 25 Lt. with Faucet

*Tanica Verticale 25 Lt. Nuda con Rubinetto*

ARTICLE	L	H	P	KG		
T963	215	480	380	1,10	1	60

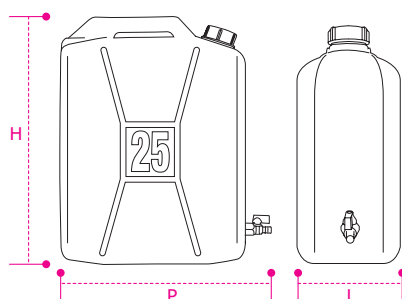



## Vertical Plastic Water Tank 10 Lt. without Faucet Food Safety Certification

*Tanica Verticale 10 Lt. Nuda senza Rubinetto ed Etichetta Certificata per Alimenti*

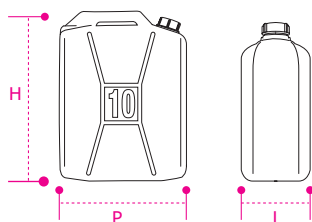

ARTICLE	L	H	P	KG		
<b>CL10</b>	156	360	240	0,45	1	60



## Vertical Plastic Water Tank 15 Lt. without Faucet Food Safety Certification

*Tanica Verticale 15 Lt. Nuda senza Rubinetto ed Etichetta Certificata per Alimenti*

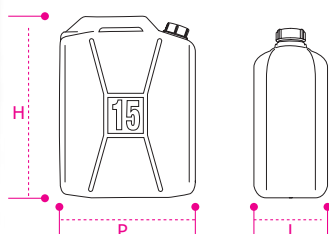

ARTICLE	L	H	P	KG		
<b>CL15</b>	176	416	286	0,60	1	60



## Vertical Plastic Water Tank 20 Lt. without Faucet Food Safety Certification

*Tanica Verticale 20 Lt. Nuda senza Rubinetto ed Etichetta Certificata per Alimenti*

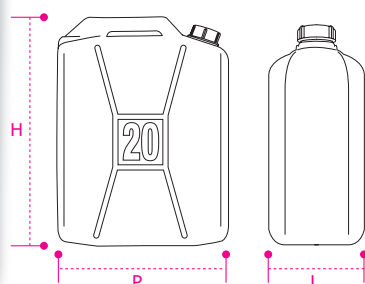

ARTICLE	L	H	P	KG		
<b>CL20</b>	190	440	315	0,75	1	60



## Vertical Plastic Water Tank 25 Lt. without Faucet Food Safety Certification

*Tanica Verticale 25 Lt. Nuda senza Rubinetto ed Etichetta Certificata per Alimenti*

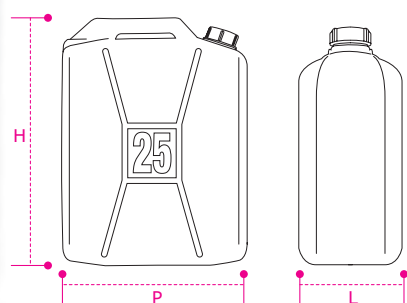

ARTICLE	L	H	P	KG		
<b>CL25</b>	215	480	335	0,80	1	60

# Support for Water Tank 25 Lt.



## Galvanized Support for Water Tank 25 Lt.

Supporto Zincato per Tanica Acqua 25 Lt.

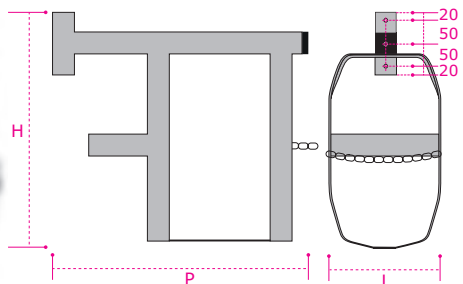

ARTICLE	L	H	P	KG	
T960	225	410	500	4,10	1

**TKcert** RINA UNI EN ISO 15614-1:2012

**i** Complete of pvc cap, chain and padlock.  
Completo di tappo in pvc, catena e lucchetto.

## Galvanized Support for Water Tank 25 Lt. with Fixing Feet

Supporto Zincato per Tanica Acqua 25 Lt. con 4 Piedini



ARTICLE	L	H	P	i L	i P	KG	
T975	225	410	395	215	275	3,85	1

**TKcert** RINA UNI EN ISO 15614-1:2012

**i** Complete of pvc cap, chain and padlock.  
Completo di tappo in pvc, catena e lucchetto.

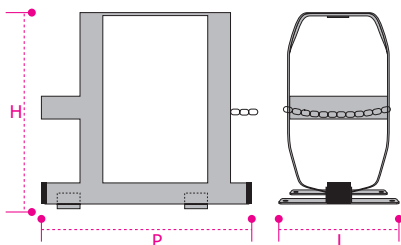

## Vertical Galvanized Support for Water Tank 25 Lt.

Supporto Zincato Verticale per Tanica Acqua 25 Lt.

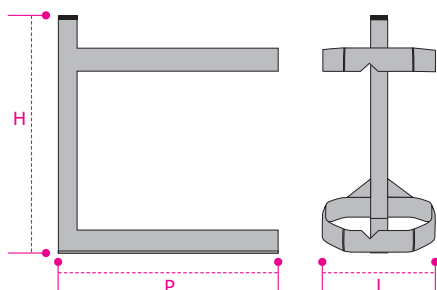

ARTICLE	L	H	P	KG	
T978	225	440	400	3,55	1

**TKcert** RINA UNI EN ISO 15614-1:2012

**i** Complete of pvc cap, chain and padlock.  
Completo di tappo in pvc, catena e lucchetto.

## Vertical Galvanized Support for Water Tank with Bracket 25 Lt.

Supporto Zincato Verticale per Tanica Acqua 25 Lt. con Staffa di Fissaggio

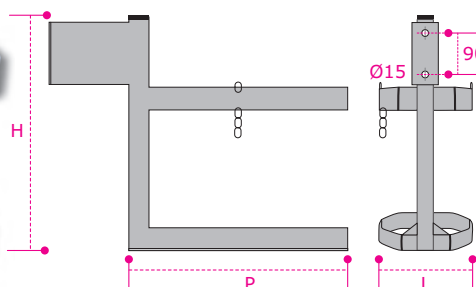

ARTICLE	L	H	P	KG	
T981	225	470	555	4,65	1

**TKcert** RINA UNI EN ISO 15614-1:2012

**i** Complete of pvc cap, chain and padlock.  
Completo di tappo in pvc, catena e lucchetto.

# Support for Water Tank 10 Lt.



## Galvanized Support for Water Tank 10 Lt.

Supporto Zincato per Tanica Acqua 10 Lt.

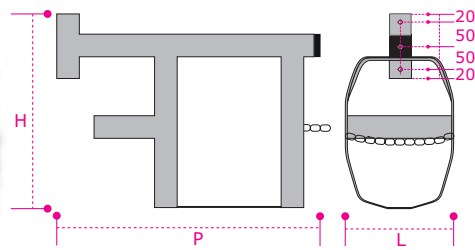

ARTICLE	L	H	P	KG	
T964	175	315	440	3,25	1

TKcert RINA UNI EN ISO 15614-1:2012

Complete of pvc cap, chain and padlock.  
Completo di tappo in pvc, catena e lucchetto.

## Galvanized Support for Water Tank 10 Lt. with Fixing Feet

Supporto Zincato per Tanica Acqua 10 Lt. con 4 Piedini

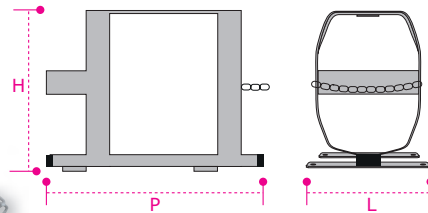

ARTICLE	L	H	P	iL	iP	KG	
T974	200	295	295	175	200	2,60	1

TKcert RINA UNI EN ISO 15614-1:2012

Complete of pvc cap, chain and padlock.  
Completo di tappo in pvc, catena e lucchetto.



## Vertical Galvanized Support for Water Tank 10 Lt.

Supporto Zincato Verticale per Tanica Acqua 10 Lt.

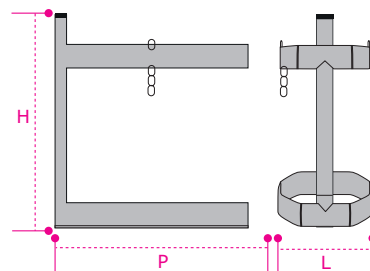

ARTICLE	L	H	P	KG	
T976	175	300	290	2,10	1

TKcert RINA UNI EN ISO 15614-1:2012

Complete of pvc cap, chain and padlock.  
Completo di tappo in pvc, catena e lucchetto.

## Galvanized Support for Water Tank 10 Lt. with Lateral Fixing

Supporto Zincato per Tanica Acqua 10 Lt. con Attacco Laterale

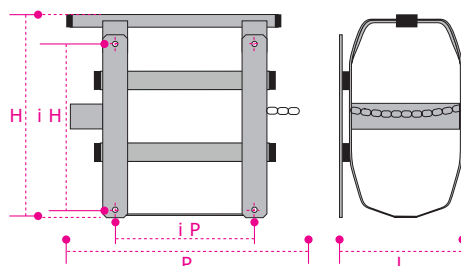

ARTICLE	L	H	P	iH	iP	KG	
T977	190	285	290	235	200	3,40	1

TKcert RINA UNI EN ISO 15614-1:2012

Complete of pvc cap, chain and padlock.  
Completo di tappo in pvc, catena e lucchetto.

# Accessories for Water Tank



## Threaded Support for Soap Dispenser Horizontal Bracket

Supporto Filettato per Portasapone Staffa Orizzontale

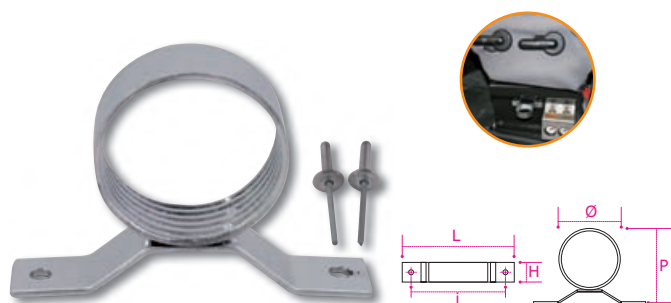

ARTICLE	L	H	P	D	i	KG	
T999	114	20	80	60	96	0,12	1

## Threaded Support for Soap Dispenser Vertical Bracket

Supporto filettato per Portasapone Staffa Verticale

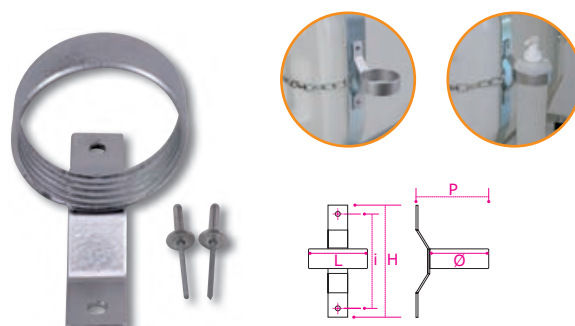

ARTICLE	L	H	P	D	i	KG	
T998	60	114	80	60	96	0,12	1

## Soap Dispenser Kit Horizontal Bracket

Kit Portasapone Staffa Orizzontale

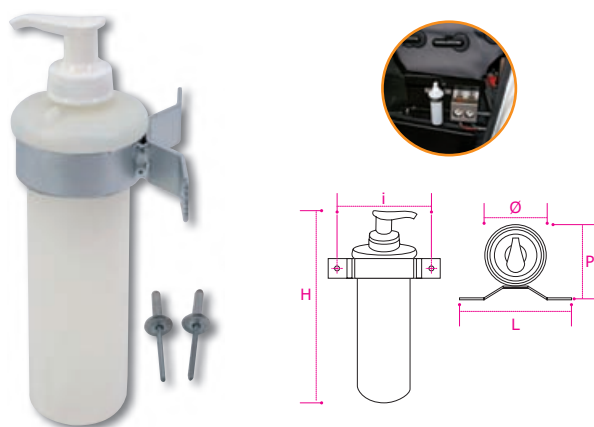

ARTICLE	L	H	P	D	i	KG	
T999K	114	200	80	60	96	0,16	1

## Soap Dispenser Kit Vertical Bracket

Kit Portasapone Staffa Verticale



ARTICLE	L	H	P	D	i	KG	
T998K	65	200	80	60	96	0,16	1

## Universal PVC Soap Dispenser

Portasapone Universale in Tpl



ARTICLE	H	D	KG	
V10026	200	60	0,07	1

## Rubber Pipe with Wrappers

Tube Cristallo e Fascetta Bifilare per Rubinetto 1/4 Ø11



ARTICLE	L	D	KG	
R70127	600	14	0,06	1

## Shock Absorbers Kit

Kit Ammortizzatori con Viti TGE 8x16



ARTICLE	H	D	KG	
R70126	25	30	0,25	1

## Kit Soap Dipenser with Antibacterial Soap 250 ml. Vertical Bracket

Kit Portasapone con Sapone Antibatterico 250 ml. Staffa Verticale



ARTICOLO	L	H	P	D	i	KG	
T998S	65	200	80	60	96	0,40	1

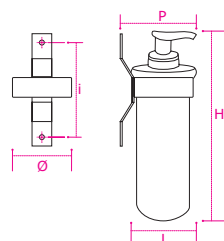

**i** Safety data sheets are inside the box. The boxes are packed with film.  
*Schede tecniche di sicurezza fornite all'interno della scatola. Le scatole sono confezionate con pellicola termorestringente.*

## Kit Soap Dipenser with Antibacterial Soap 250 ml. Horizontal Bracket

Kit Portasapone con Sapone Antibatterico 250 ml. Staffa Orizzontale



ARTICOLO	L	H	P	D	i	KG	
T999S	114	200	80	60	96	0,40	1

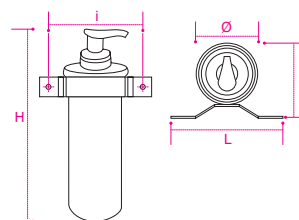

**i** Safety data sheets are inside the box. The boxes are packed with film.  
*Schede tecniche di sicurezza fornite all'interno della scatola. Le scatole sono confezionate con pellicola termorestringente.*

## Universal Pvc Dispenser with Antibacterial Soap

Portasapone Universale in Tpl con Sapone Antibatterico



ARTICOLO	H	D	KG	
V10026S	200	60	0,30	1

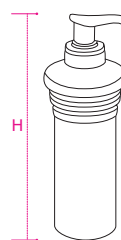

**i** Safety data sheets are inside the box. The boxes are packed with film.  
*Schede tecniche di sicurezza fornite all'interno della scatola. Le scatole sono confezionate con pellicola termorestringente.*



# Stainless Steel Water Tank



## Stainless Steel Ba Mirror Water Tank 12 Lt.

Tanica Acciaio Inox 304 BA Specchiato 12 Lt.

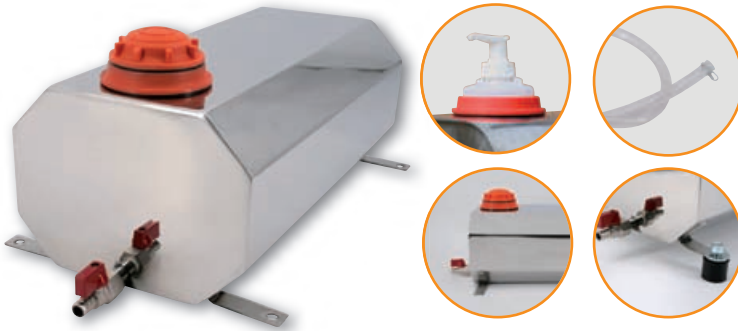

ARTICLE	L	H	P	KG	
V10078	130	145	400	4,15	1

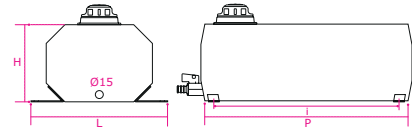

## Flowered Stainless Steel Water Tank 12 Lt.

Tanica Acciaio Inox Fiore 12 Lt.



ARTICLE	L	H	P	KG	
V10020	175	180	450	3,30	1

**i** Soap dispenser and support bracket are supplied separately.  
Portasapone e staffa supporto posteriore vengono vendute separatamente.

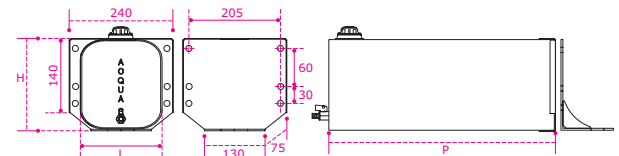

## Stainless Steel Support Bracket for Tank V10020

Staffa Inox 2B per Tanica V10020

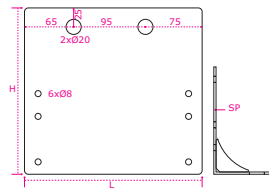
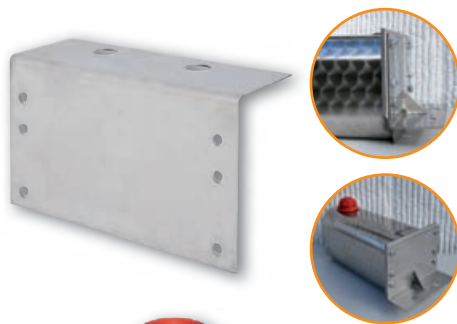

ARTICLE	L	H	SP	i	KG	
S68000	235	139	30/10	310	0,80	1

## Flowered Stainless Steel Water Tank 12 Lt.

Tanica Acciaio Inox Fiore 12 Lt. Fissaggio con Piedini



ARTICLE	L	H	P	i	KG	
V10037	175	180	410	310	3,30	1

**i** Soap dispenser supplied separately.  
Portasapone fornito separatamente.

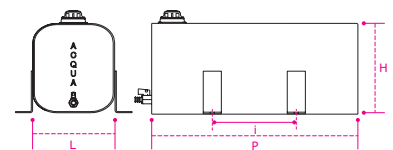

## Flowered Stainless Steel Water Tank 12 Lt.

Tanica Inox Fiore 12 Lt. con Attacchi Laterali ad Ala di Gabbiano

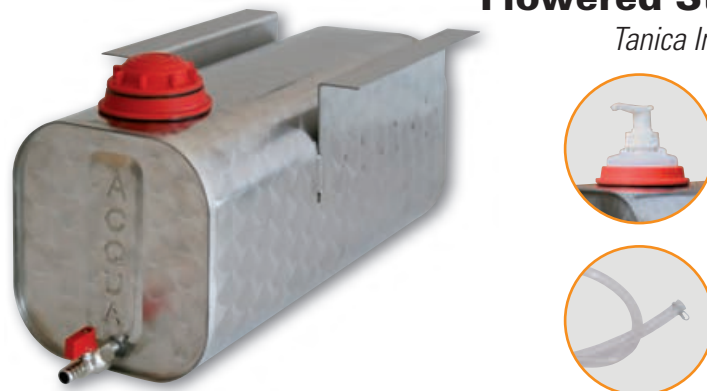

ARTICLE	L	H	P	KG	
V10028	170	180	410	3,40	1

**i** Soap dispenser supplied separately.  
Portasapone fornito separatamente.

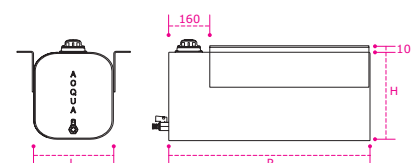

# Stainless Steel Water Tank



## Flowered Stainless Steel Water Tank 8 Lt.

*Tanica Acciaio Inox Fiore Piccola 8 Lt.*



ARTICLE	L	H	P	KG	
V10035	170	180	250	2,20	1

**i** Soap dispenser supplied separately.  
*Portasapone fornito separatamente.*

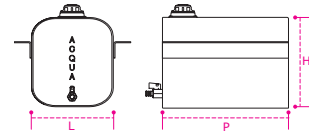

## Flowered Stainless Steel Water Tank 25 Lt.

*Tanica Acciaio Inox Fiore 25 Lt.*

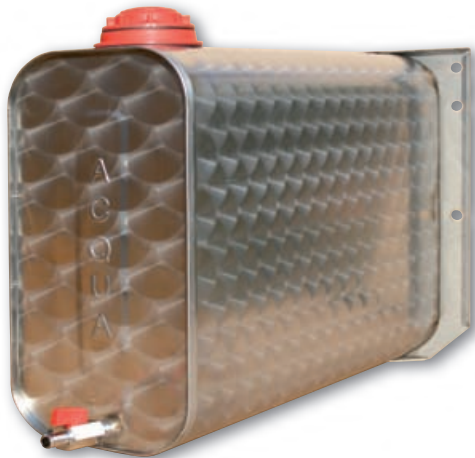

ARTICLE	L	H	P	KG	
V10021	175	400	450	5,70	1

**i** Soap dispenser supplied separately.  
*Portasapone fornito separatamente.*

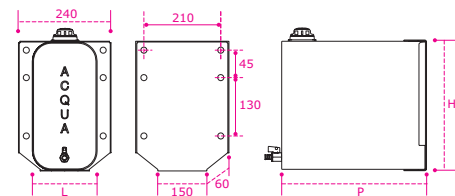

## Flowered Stainless Steel Water Tank 25 Lt.

*Tanica Acciaio Inox Fiore 25 Lt. con Attacchi Laterali ad Ala di Gabbiano*

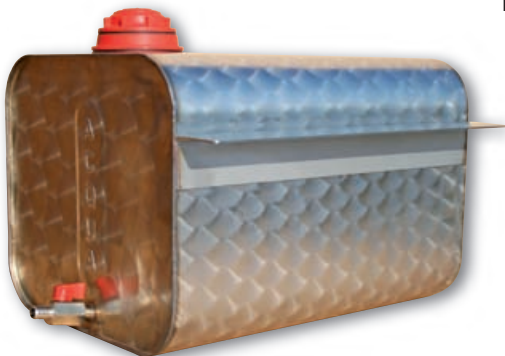

ARTICLE	L	H	P	KG	
V10022	285	295	420	4,00	1

**i** Soap dispenser supplied separately.  
*Portasapone fornito separatamente.*

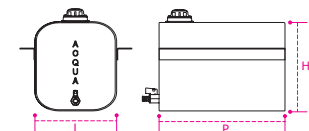

## Flowered Stainless Steel Water Tank 25 Lt.

*Tanica Acciaio Inox Fiore 25 Lt. Fissaggio con Piedini*

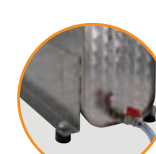

ARTICLE	L	H	P	i	KG	
V10039	175	400	410	310	5,70	1

**i** Soap dispenser supplied separately.  
*Portasapone fornito separatamente.*

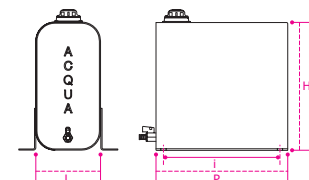

# Tubular Water Tanks

## Stainless Steel BA Tubular Water Tank for SCANIA NEW GENERATION

*Tanica Acqua a Tubo Inox BA per SCANIA NEW GENERATION*



ARTICLE	H	D	i	KG	
V10070	1280	110	430	5,50	1

## Stainless Steel BA Tubular Water Tank for SCANIA R2/R3

*Tanica Acqua a Tubo Inox BA per SCANIA R2/R3*

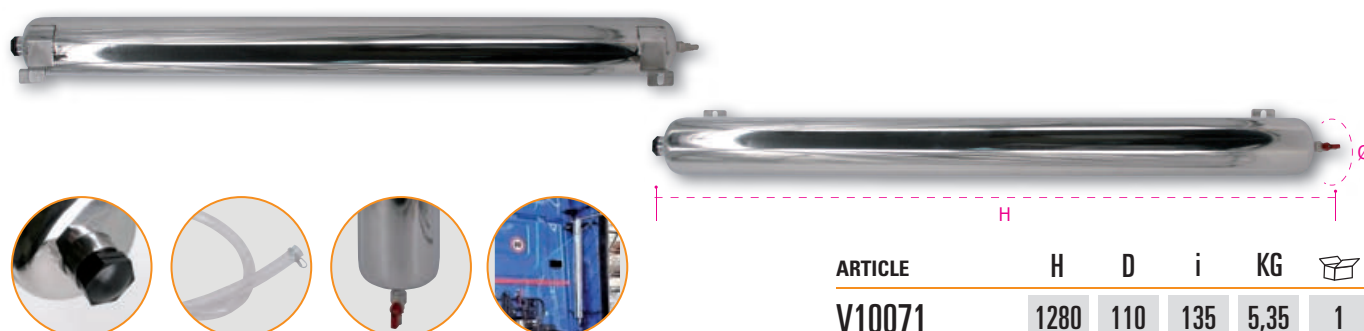

ARTICLE	H	D	i	KG	
V10071	1280	110	135	5,35	1

## Stainless Steel BA Tubular Water Tank for VOLVO FH4

*Tanica Acqua a Tubo Inox BA per VOLVO FH4*



ARTICLE	H	D	i	KG	
V10072	1280	110	645	5,55	1

## Stainless Steel BA Tubular Water Tank for DAF XF 106

*Tanica Acqua a Tubo Inox BA per DAF XF 106*



ARTICLE	H	D	i	KG	
V10073	1280	110	785	5,50	1

# Tubular Water Tanks



## Stainless Steel BA Tubular Water Tank for MERCEDES MP4

*Tanica Acqua a Tubo Inox BA per MERCEDES MP4*

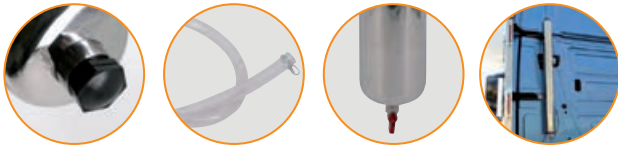
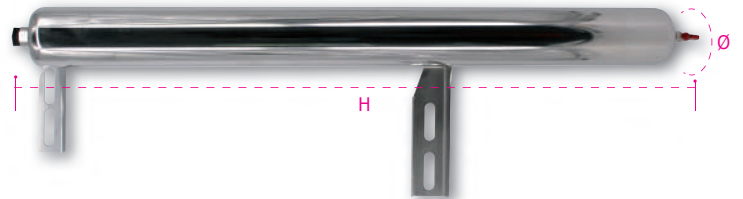

ARTICLE	H	D	i	KG	
V10074	1280	110	785	6,75	1

## Stainless Steel BA Tubular Water Tank for MAN E6 - TGX

*Tanica Acqua a Tubo Inox BA per MAN E6 - TGX*

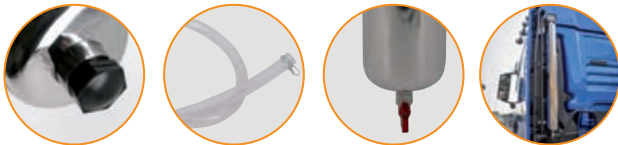
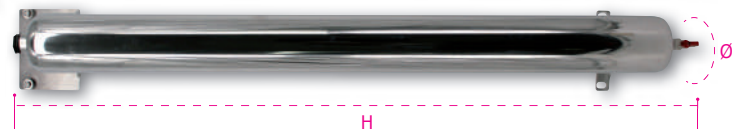

ARTICLE	H	D	i	KG	
V10075	1280	110	1250	6,50	1

## Stainless Steel BA Tubular Water Tank for RENAULT T

*Tanica Acqua a Tubo Inox BA per RENAULT T*

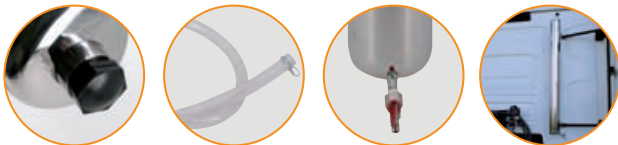
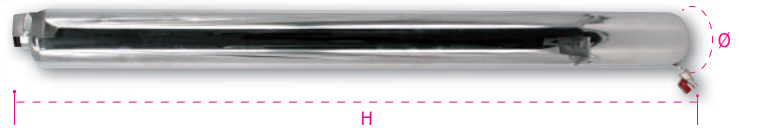

ARTICLE	H	D	i	KG	
V10076	1280	110	965	5,55	1

## Stainless Steel BA Tubular Water Tank for IVECO HI-WAY

*Tanica Acqua a Tubo Inox BA per IVECO HI-WAY*

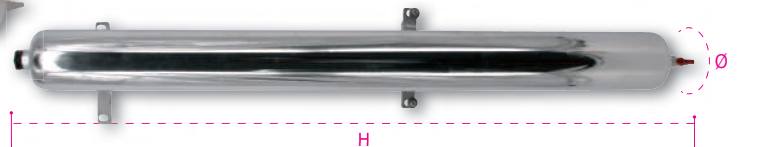

ARTICLE	H	D	i	KG	
V10077	1280	110	640	6,70	1

## Stainless Steel BA Tubular Water Tank for IVECO S-WAY

*Tanica Acqua a Tubo Inox BA per IVECO S-WAY*



ARTICLE	H	D	i	KG	
V10079	1280	110	730	6,70	1

# Reservoir and Recovery Tank



## Flowered Stainless Steel Recovery Tank for Sewage 8 Lt. with Inox Inspection

Tanica Acciaio Inox Fiorettato Recupero Liquami 8 Lt. con Ispezione Inox



ARTICLE	L	H	P	SP	KG	
070002/I	200	200	250	15/10	5,10	1

**TKcert**RINA UNI EN ISO 15614-1:2012

**i** Continuous support brackets.  
Staffe supporto continue.

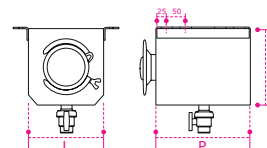

## Flowered Stainless Steel Recovery Tank for Sewage 14 Lt. with Inox Inspection

Tanica Acciaio Inox Fiorettato Recupero Liquami 14 Lt. con Ispezione Inox



ARTICLE	L	H	P	SP	KG	
070001/I	300	250	250	15/10	6,85	1

**TKcert**RINA UNI EN ISO 15614-1:2012

**i** Continuous support brackets.  
Staffe supporto continue.

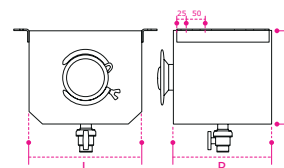

## Flowered Stainless Steel Recovery Tank for Sewage 27 Lt. with Inox Inspection

Tanica Acciaio Inox Fiorettato Recupero Liquami 27 Lt. con Ispezione Inox

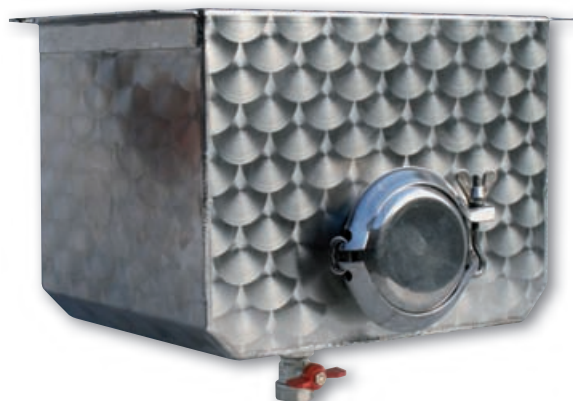

ARTICLE	L	H	P	SP	KG	
070010/I	400	300	300	15/10	9,60	1

**TKcert**RINA UNI EN ISO 15614-1:2012

**i** Continuous support brackets.  
Staffe supporto continue.

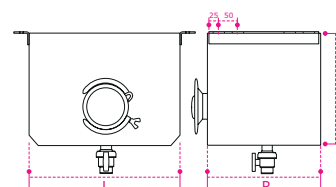
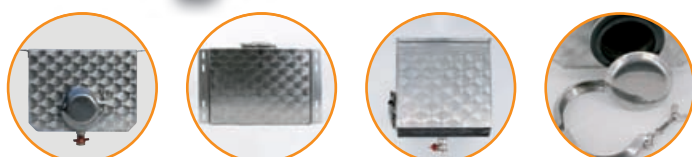

# Reservoir and Recovery Tank

## Flowered Stainless Steel Recovery Tank for Sewage 45 Lt. with Inox Inspection

Tanica Acciaio Inox Fiorettato Recupero Liquami 45 Lt. con Ispezione Inox



ARTICLE	L	H	P	SP	KG	
070011/I	600	250	400	15/10	13,50	1

**TKcert** RINA UNI EN ISO 15614-1:2012

**i** Continuous support brackets. Ideal for Semi-trailers Lamberet Model.  
Staffe supporto continue. Ideale per Semirimorchi Mod. Lamberet.

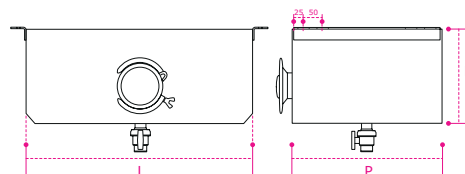

## Flowered Stainless Steel Recovery Tank for Sewage with PVC Inspection

Tanica Recupero Liquami con Ispezione Pvc

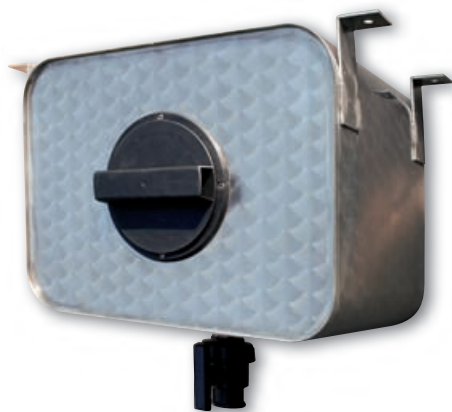

ARTICLE	L	H	P	SP	KG	
070001	300	250	250	8/10	4,00	1
070010	390	290	300	8/10	7,90	1

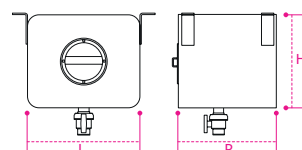

## Fiberglass Recovery Tank for Sewage with Pvc Inspection

Vaschetta Recupero Liquami in Vetroresina con ispezione PVC



ARTICLE	L	H	P	SP	KG	
V10048SL	240	110	400	40/10	1,30	1

**i** Drain valve included in the kit but not installed.  
Valvola di drenaggio inclusa ma non installata.

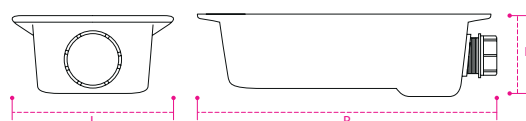

# Accessories for Water Tank

## Anti-theft Cap for Water Tank with Double Keys

Tappo Antifurto per Tanica Acqua con Doppia Chiave

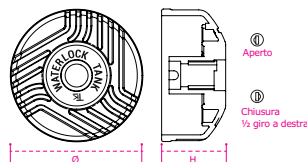

ARTICLE	H	D	KG	
111P	36	74	0,124	1

**i** Assembly sheet supplied inside the box.  
Lo schema di montaggio è fornito all'interno della scatola.

## PVC Cap

Tappo PVC

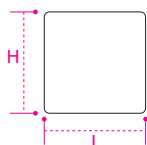

ARTICLE	L	H	KG	
110318202N	40	40	0,01	1
110318302N	50	50	0,08	1
ILR50X25	50	25	0,01	1
ILR30X15	30	15	0,01	1

## Padlock

Lucchetto



ARTICLE	L	H	KG	
R60102	25	15	0,02	1

## PVC Faucet

Rubinetto PVC Recupero Liquami



ARTICLE	L	H	KG	
V20016	70	105	0,07	1

## Faucet 1/4

Rubinetto Dritto Passo 1/4



ARTICLE	PA	L	D	KG	
V20018	1/4	45	11	0,83	1

## PVC Faucet for Water Tank 30 Lt.

Rubinetto Tanica 30 Lt.

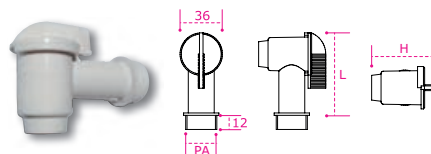

ARTICLE	L	H	PA	KG	
V20013	70	57	3/4	0,02	1

## Pvc Cap

Tappo Tanica 30 Lt.



ARTICLE	D	KG	
V20014	60	0,03	1

## Inspection Cap

Tappo Ispezione



ARTICLE	D	KG	
V20015	140	0,08	1

## PVC Cap

Tappo PVC



ARTICLE	H	D	KG	
111	30	60	0,017	1

# Mudflaps

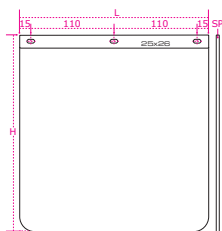

## Neutral Mudflap 250

Paraspruzzo Neutro 250

ARTICLE	L	H	SP	KG	
S25273	250	260	4	0,36	100

**i** Neutral mudflaps are supplied without fixing bar and screws kit.  
I paraspruzzi neutri vengono forniti senza astine e kit di fissaggio.

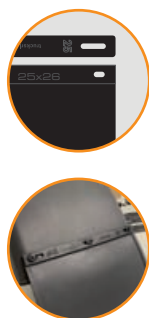
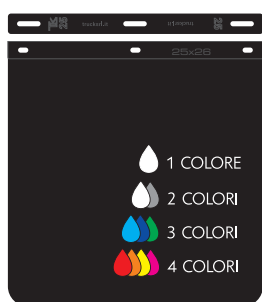

## Customized Mudflap 250

Paraspruzzo Personalizzato 250

ARTICLE	COL	L	H	SP	KG	
S25274	1	250	260	4	0,38	100
S25275	2	250	260	4	0,38	100
S25276	3	250	260	4	0,38	100
S25277	4	250	260	4	0,38	100

**i** Customized mudflaps are supplied with fixing bar and screws kit.  
I paraspruzzi personalizzati vengono forniti completi di astine senza kit di fissaggio.

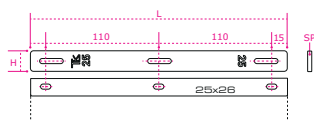

## PPE Black Fixing Bar for Mudflap 250

Astina di Fissaggio PPE Nero per Paraspruzzo 250

ARTICLE	L	H	SP	KG	
AS25TK	250	20	4	0,12	40

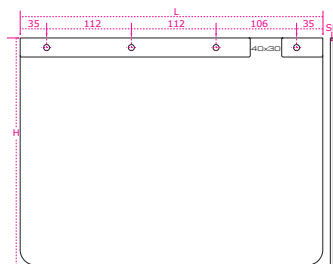

## Neutral Mudflap 400

Paraspruzzo Neutro 400

ARTICLE	L	H	SP	KG	
S40303	400	300	4	0,57	100

**i** Neutral mudflaps are supplied without fixing bar and screws kit.  
I paraspruzzi neutri vengono forniti senza astine e kit di fissaggio.

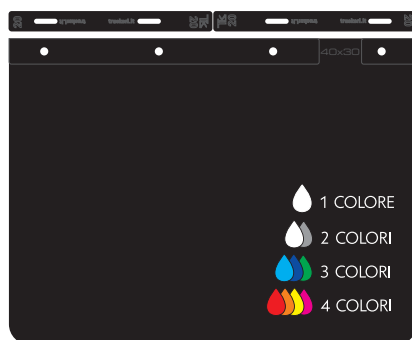

## Customized Mudflap 400

Paraspruzzo Personalizzato 400

ARTICLE	COL	L	H	SP	KG	
S40304	1	400	300	4	0,59	100
S40355	2	400	300	4	0,59	100
S40356	3	400	300	4	0,59	100
S40357	4	400	300	4	0,59	100

**i** Customized mudflaps are supplied with fixing bar and screws kit.  
I paraspruzzi personalizzati vengono forniti completi di astine senza kit di fissaggio.

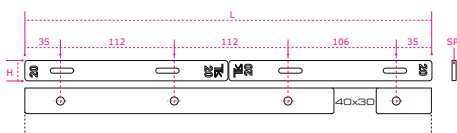

## PPE Black Fixing Bar for Mudflap 400

Astina di Fissaggio PPE Nero per Paraspruzzo 400

ARTICLE	L	H	SP	KG	
AS40TK	400	20	4	0,19	40



# Mudflaps

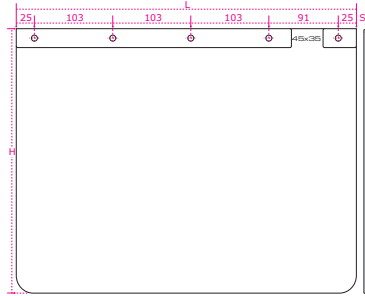
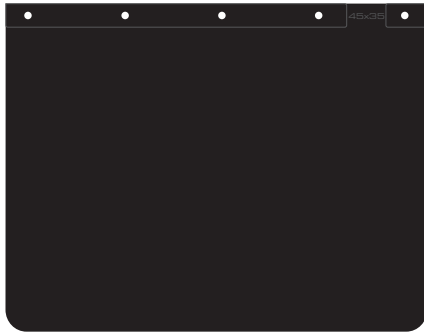

## Neutral Mudflap 450

Paraspruzzo Neutro 450

ARTICLE	L	H	SP	KG	
S45353	450	350	4	0,83	100

**i** Neutral mudflaps are supplied without fixing bar and screws kit.  
I paraspruzzi neutri vengono forniti senza astine e kit di fissaggio.

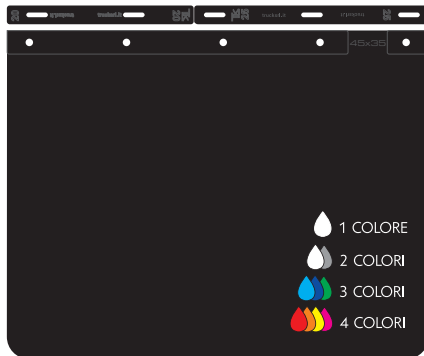

## Customized Mudflap 450

Paraspruzzo Personalizzato 450

ARTICLE	COL	L	H	SP	KG	
S45354	1	450	350	4	0,84	100
S45355	2	450	350	4	0,84	100
S45356	3	450	350	4	0,84	100
S45357	4	450	350	4	0,84	100

**i** Customized mudflaps are supplied with fixing bar and screws kit.  
I paraspruzzi personalizzati vengono forniti completi di astine senza kit di fissaggio.

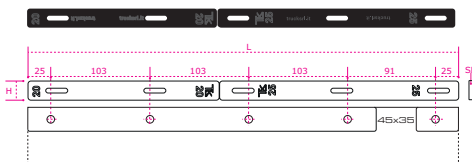

## PPE Black Fixing Bar for Mudflap 450

Astina di Fissaggio PPE Nero per Paraspruzzo 450

ARTICLE	L	H	SP	KG	
AS45TK	450	20	4	0,22	40

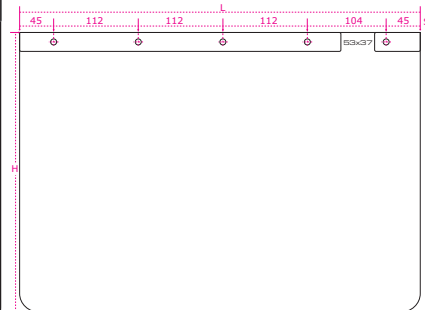
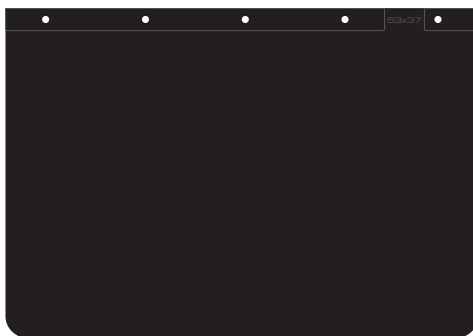

## Neutral Mudflap 530

Paraspruzzo Neutro 530

ARTICLE	L	H	SP	KG	
S53373	530	370	4	1,12	100

**i** Neutral mudflaps are supplied without fixing bar and screws kit.  
I paraspruzzi neutri vengono forniti senza astine e kit di fissaggio.

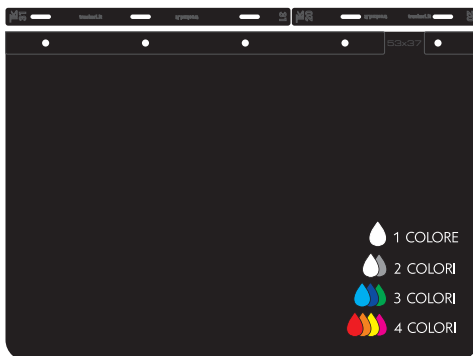

## Customized Mudflap 530

Paraspruzzo Personalizzato 530

ARTICLE	COL	L	H	SP	KG	
S53374	1	530	370	4	1,14	100
S53375	2	530	370	4	1,14	100
S53376	3	530	370	4	1,14	100
S53377	4	530	370	4	1,14	100

**i** Customized mudflaps are supplied with fixing bar and screws kit.  
I paraspruzzi personalizzati vengono forniti completi di astine senza kit di fissaggio.

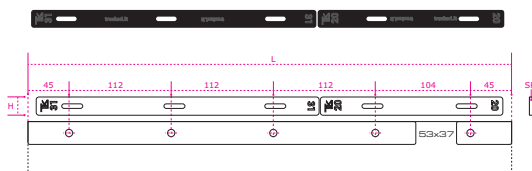

## PPE Black Fixing Bar for Mudflap 530

Astina di Fissaggio PPE Nero per Paraspruzzo 530

ARTICLE	L	H	SP	KG	
AS53TK	530	20	4	0,26	40

# Mudflaps

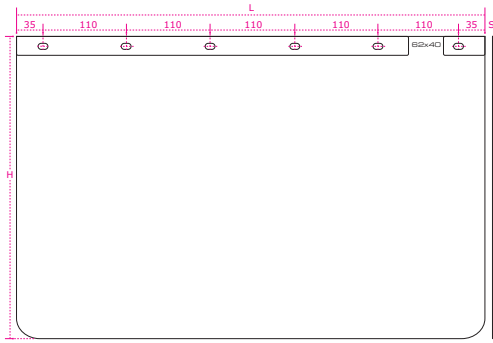

## Neutral Mudflap 620

Paraspruzzo Neutro 620

ARTICLE	L	H	SP	KG	
<b>S62403</b>	620	400	4	1,18	100

**i** Neutral mudflaps are supplied without fixing bar and screws kit.  
I paraspruzzi neutri vengono forniti senza astine e kit di fissaggio.

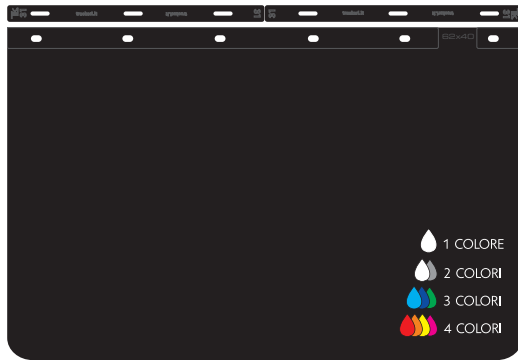

## Customized Mudflap 620

Paraspruzzo Personalizzato 620

ARTICLE	COL	L	H	SP	KG	
<b>S62404</b>	1	620	400	4	1,21	100
<b>S62405</b>	2	620	400	4	1,21	100
<b>S62406</b>	3	620	400	4	1,21	100
<b>S62407</b>	4	620	400	4	1,21	100

**i** Customized mudflaps are supplied with fixing bar and screws kit.  
I paraspruzzi personalizzati vengono forniti completi di astine senza kit di fissaggio.

## PPE Black Fixing Bar for Mudflap 620 Astina di Fissaggio PPE Nero per Paraspruzzo 620

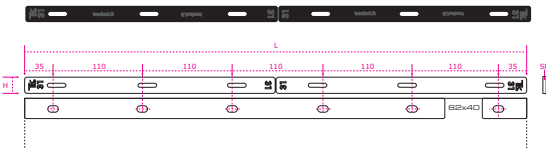

ARTICLE	L	H	SP	KG	
<b>AS62TK</b>	620	20	4	0,32	40

## Calculation of Rivets for Mounting On Mudflaps Calcolo dei Rivetti per il montaggio sui Paraspruzzi

Width Mudflap Larghezza Paraspruzzo	250	400	450	530	620
Number of Holes Numero dei fori	3	4	5	6	7
Quantity Mudflaps Quantità Paraspruzzi <b>20</b>	60	80	100	120	140
Quantity Mudflaps Quantità Paraspruzzi <b>50</b>	150	200	250	300	350
Quantity Mudflaps Quantità Paraspruzzi <b>100</b>	300	400	500	600	700
Quantity Mudflaps Quantità Paraspruzzi <b>200</b>	600	800	1000	1200	1400

1 Pack  
1 Confezione

2 Packs  
2 Confezioni

3 Packs  
3 Confezioni

## Black Rivet Kit Kit Rivetti Neri



ARTICLE	DESCRIPTION	KG
<b>RIV4821S</b>	Black Rivet Kit - 4,8x21 T. 14 - pcs 200 Kit Rivetti Neri - 4,8x21 T. 14 - Pezzi 200	0,79

## Black Washer Kit Kit Rondelle Nere



ARTICLE	DESCRIPTION	KG
<b>R520N</b>	Black Washer Kit - 5x20 - pcs 200 Kit Rondelle Nere - 5x20 - Pezzi 200	0,20

# Mudflaps



## Pair of Mudflaps with Signals *Coppia Paraspruzzi Freccia/Divieto*

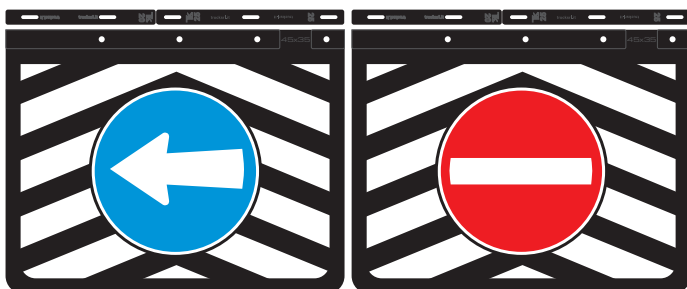

ARTICLE	L	H	SP	KG	KIT
FD4030	400	300	4	1,10	1
FD4535	450	350	4	1,60	1
FD5337	530	370	4	2,40	1
FD6240	620	400	4	2,75	1

**i** Pair of mudflaps with signals delivered in a single kit with fixing bars and bolts. *Coppia di paraspruzzi freccia/divieto consegnati in kit unico completo di astine e bulloneria.*

## Long Mudflap with Signals *Paraspruzzo Lungo per Traverse Freccia/Divieto*



ARTICLE	L	H	SP	KG	
FD2402	2400	350	4	3,80	1



**i** Long mudflap with signals delivered in a single kit with PVC fixing bars. *Paraspruzzo lungo freccia/divieto consegnato in kit comprensivo di aste PVC di fissaggio.*

ARTICLE	L	H	SP	KG	
FD2401	2400	350	4	3,80	1

## 2 Rivet Kit *Kit 2 Rivetti*



ARTICLE	D	L	KG	
R70125	7,8	18	0,12	1

## Fixing Bar for Mudflap *Asta di Fissaggio*

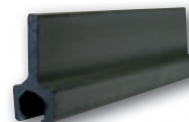

ARTICLE	L	H	SP	KG	
AST1	1200	34	1,8	0,210	2

## Stainless Steel Hinge with Holes *Cerniera Inox con Fori*

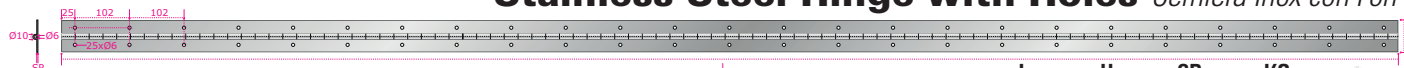

ARTICLE	L	H	SP	KG	
C400	2500	60	20/10	3,30	1

## Galvanized Fixing Bar for Mudflap - Old Model *Astina Di Fissaggio - Vecchio Modello*

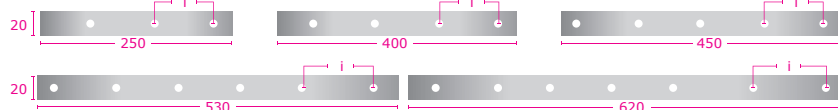

ARTICLE	L	H	i	D	SP	KG	
AS25	250	20	110	8	8/10	0,03	100
AS40	400	20	112	8	8/10	0,04	100
AS45	450	20	102	8	8/10	0,05	100
AS53	530	20	112	8	8/10	0,06	100
AS62	620	20	110	8	8/10	0,07	100



ARTICLE	DESCRIPTION	KG
R70124	Screws Kit - 5x20 (7) - 5x0,8 (7) - Flat Screw Ø5 (14) Viti - 5x20 (7) - 5x0,8 (7) - Piana Ø5 (14)	0,05

## Screws Kit *Kit Viti*

## Long Black Mudflap *Paraspruzzo Nero Lungo per Traverse*



### Neutral Mudflap

*Neutro*

ARTICLE	L	H	SP	KG	
S24038	2400	350	4	3,80	1

**i** Neutral mudflaps are supplied without fixing bar and screws kit.  
*I paraspruzzi neutri vengono forniti senza astine e kit di fissaggio.*

### Customized Mudflap

*Personalizzato*

ARTICLE	COL	L	H	SP	KG	
S240381	1	2400	350	4	3,80	10
S240382	2	2400	350	4	3,80	10
S240383	3	2400	350	4	3,80	10
S240384	4	2400	350	4	3,80	10

**i** Customized mudflaps are supplied with fixing bar and screws kit.  
*I paraspruzzi personalizzati vengono forniti completi di astine senza kit di fissaggio.*

### Printing Plant

*Clichè*

ARTICLE	DESCRIPTION
C35001	Small Cliché Clichè piccolo
C35002	Large Cliché Clichè grande
C35003	Graphic Processing Elaborazione grafica
C35000	Further Colour Ulteriore colore

## Long White Mudflap *Paraspruzzo Bianco Lungo per Traverse*



### Neutral Mudflap

*Neutro*

ARTICLE	L	H	SP	KG	
S24038B	2400	350	4	3,80	1

**i** Neutral mudflaps are supplied without fixing bar and screws kit.  
*I paraspruzzi neutri vengono forniti senza astine e kit di fissaggio.*

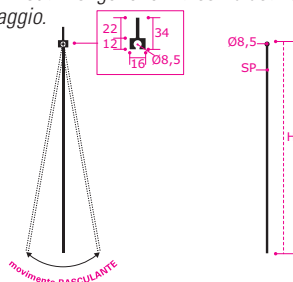

### Customized Mudflap

*Personalizzato*

ARTICLE	COL	L	H	SP	KG	
S240381B	1	2400	350	4	3,80	10
S240382B	2	2400	350	4	3,80	10
S240383B	3	2400	350	4	3,80	10
S240384B	4	2400	350	4	3,80	10

**i** Customized mudflaps are supplied with fixing bar and screws kit.  
*I paraspruzzi personalizzati vengono forniti completi di astine senza kit di fissaggio.*

### Printing Plant

*Clichè*

ARTICLE	DESCRIPTION
C35001	Small Cliché Clichè piccolo
C35002	Large Cliché Clichè grande
C35003	Graphic Processing Elaborazione grafica
C35000	Further Colour Ulteriore Colore

# Mudflaps



## Homologated Antispray Mudflap - 91/226/EEC

Paraspruzzo Antispray Omologato - Dir. 91/226/EEC

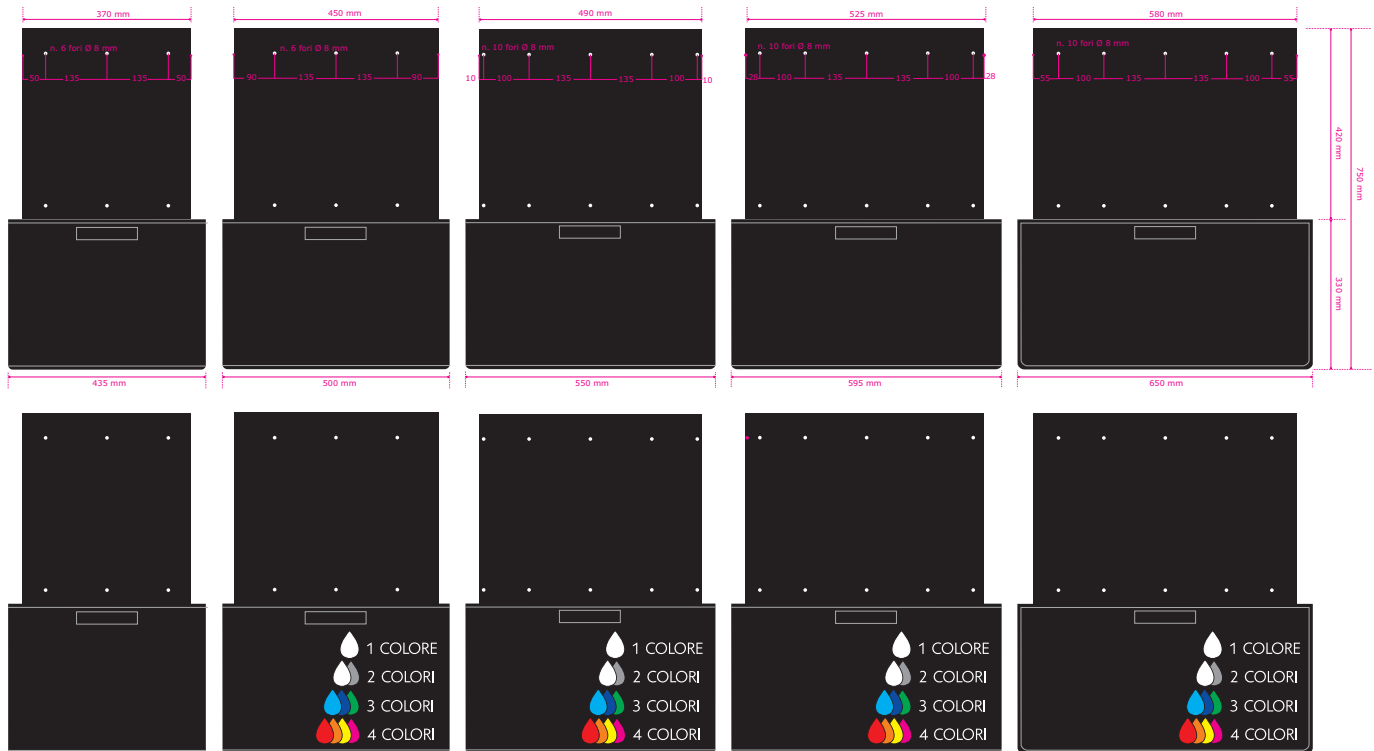

### Neutral Mudflap *Neutro*

ARTICLE	L	H	i	KG	
CPF7543	435	750	20	1,10	2
CPF7550	500	750	20	1,35	2
CPF7555	550	750	20	1,45	2
CPF7560	600	750	20	1,60	2
CPF7565	650	750	20	1,70	2

### Mudflap 1 Colour *Personalizzato 1 colore*

ARTICLE	L	H	Print Measures Spazio Serigrafia
CPF75431	435	750	41,5x28
CPF75501	500	750	47x28
CPF75551	550	750	52x28
CPF75601	600	750	57x28
CPF75651	650	750	60x28

### Mudflap 2 Colours *Personalizzato 2 colori*

ARTICLE	L	H	Print Measures Spazio Serigrafia
CPF75432	435	750	41,5x28
CPF75502	500	750	47x28
CPF75552	550	750	52x28
CPF75602	600	750	57x28
CPF75652	650	750	60x28

### Mudflap 3 Colours *Personalizzato 3 colori*

ARTICLE	L	H	Print Meas. Spazio Ser.
CPF75433	435	750	41,5x28
CPF75503	500	750	47x28
CPF75553	550	750	52x28
CPF75603	600	750	57x28
CPF75653	650	750	60x28

### Printing Plant *Clichè*

ARTICLE	DESCRIPTION
C35001	Small Clichè Clichè piccolo
C35002	Large Clichè Clichè grande
C35003	Graphic Processing Elaborazione grafica
C35000	Further Colour Ulteriore Colore

### Fitting Kit *Kit Viti*



ARTICLE	D	L	KG	
R70122	8	25	0,12	1

### Rivet Kit *Kit Rivetti*



ARTICLE	D	L	KG	
R70125	7,8	18	0,12	1

**i** Homologated antispray mudflap, excellent resistance to atmospheric elements, excellent flexibility for assembly, excellent customised printing space.  
*Paraspruzzo antispray omologato, ottima resistenza agli agenti atmosferici, ottima flessibilità per il montaggio, ottimo spazio serigrafabile per la personalizzazione.*

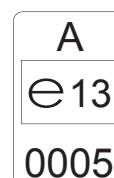



## Homologated Antispray Mudflap - 91/226/EEC

Paraspruzzo Antispray Omologato - Dir. 91/226/EEC

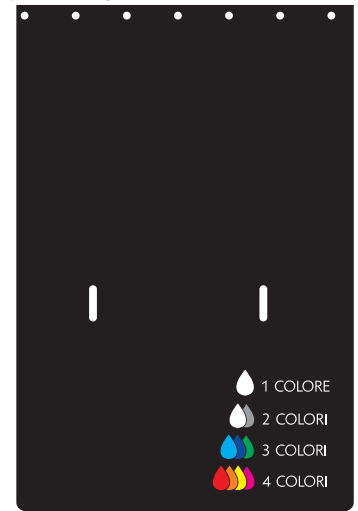
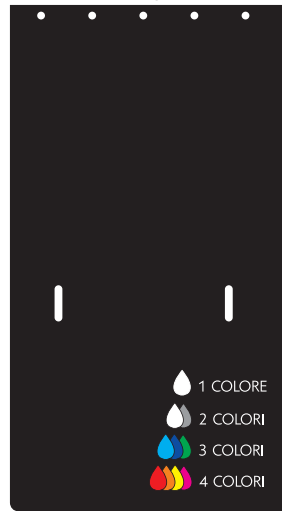
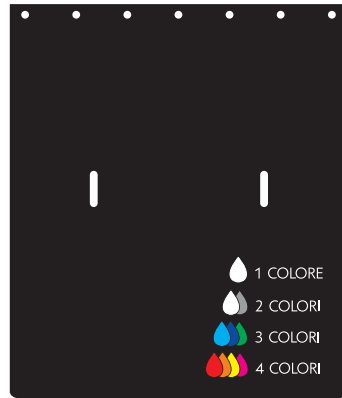
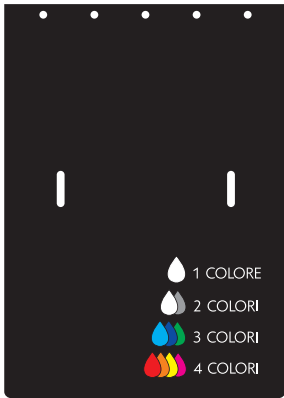

A  
e24  
0003

**i** Homologated antispray mudflap for trailers and semi trailers.  
Paraspruzzo antispray omologato per rimorchi e semirimorchi.

### Neutral Mudflap

Neutro

ARTICLE	L	H	SP	KG	
SK5070	500	700	15	3,10	1
SK5090	500	900	15	3,70	1
SK6070	600	700	15	4,50	1
SK6090	600	900	15	4,80	1

### Mudflap 1 Colour

Personalizzato 1 colore

ARTICLE	L	H	Print Measures Spazio Serigrafia
SK5071	500	700	45x28
SK5091	500	900	45x28
SK6071	600	700	45x28
SK6091	600	900	45x28

### Mudflap 2 Colours

Personalizzato 2 colori

ARTICLE	L	H	Print Measures Spazio Serigrafia
SK5072	500	700	45x28
SK5092	500	900	45x28
SK6072	600	700	45x28
SK6092	600	900	45x28

### Mudflap 3 Colours

Personalizzato 3 colori

ARTICLE	L	H	Print Measures Spazio Serigrafia
SK5073	500	700	45x28
SK5093	500	900	45x28
SK6073	600	700	45x28
SK6093	600	900	45x28

### Printing Plant

Clichè

ARTICLE	DESCRIPTION
C35001	Small Cliché Clichè piccolo
C35002	Large Cliché Clichè grande
C35003	Graphic Processing Elaborazione grafica
C35000	Further Colour Ulteriore Colore

### Fixing Hook

Gancio di Fissaggio



ARTICLE	L	H	KG	
SK5001	20	80	0,08	1



### Fixing Bar for Antispray Mudflap

Staffa Fissaggio

	ARTICLE	L	H	i	D	SP	KG	
for article per cod. SK5070	SK5033	500	330	9,7	10	2	1,30	1
for article per cod. SK5090	SK5053	500	530	9,7	10	2	1,70	1
for article per cod. SK6070	SK6033	600	330	9,7	10	2	1,46	1
for article per cod. SK6090	SK6053	600	530	9,7	10	2	1,80	1

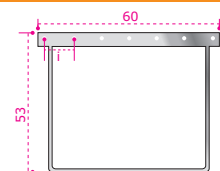
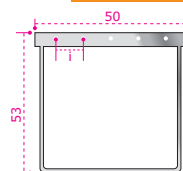
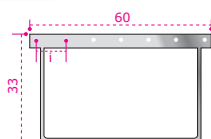
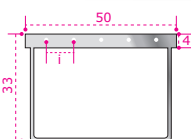

# Bumper Bars



## Bumper Bar for Nissan Cabstar

Barra Paraincastri Nissan Cabstar

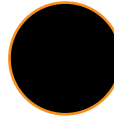

RAL 9005  
LUCIDO  
GLOSSY

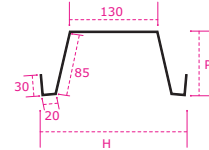

ARTICLE	L	H	P	SP	KG	
R20102	1730	216	95	20/10	11,20	1

**i** Attention: it is supplied without PVC caps.  
Attenzione: E' fornita senza il tampone laterale in PVC.

## Bumper Bar for Daily >2000

Barra Paraincastri Daily >2000

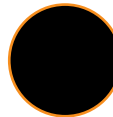

RAL 9005  
LUCIDO  
GLOSSY

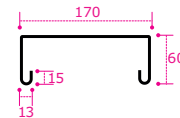

ARTICLE	L	H	P	SP	KG	
R10101	1900	175	70	15/10	8,20	1

## Complete Bumper Bar for Daily >2000

Barra Paraincastri Daily >2000

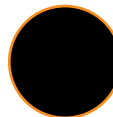

RAL 9005  
LUCIDO  
GLOSSY

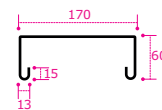

ARTICLE	L	H	P	SP	KG	
R10101C	1900	175	70	15/10	9,80	1

# Bumper Bars



## Grey Painted Lamp Holder Bar

Barra Portafanali Grigia

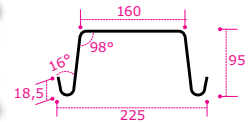

RAL 7015  
LUCIDO  
GLOSSY

ARTICLE	L	H	P	SP	KG		ARTICLE	L	H	P	SP	KG	
P170	1700	230	100	15/10	8,30	1	P210	2100	230	100	15/10	10,00	1
P180	1800	230	100	15/10	8,60	1	P220	2200	230	100	15/10	10,50	1
P190	1900	230	100	15/10	8,80	1	P230	2300	230	100	15/10	11,00	1
P160	1600	230	100	15/10	7,90	1	P240	2400	230	100	15/10	11,20	1

**i** Attention: to be installed only in presence of approved bumper bar.  
Attenzione: da installare solo in presenza di barra paraincastri omologata.

## Complete Grey Painted Lamp Holder Bar

Barra Portafanali Completa

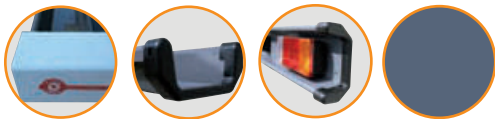
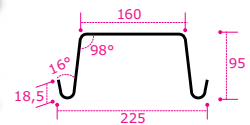

RAL 7015  
LUCIDO  
GLOSSY

ARTICLE	L	H	P	SP	KG	
PC230	2300	230	100	15/10	12,90	50
PC240	2400	230	100	15/10	13,50	45

**i** Attention: to be installed only in presence of approved bumper bar.  
Attenzione: da installare solo in presenza di barra paraincastri omologata.

## White Painted Lamp Holder Bar

Barra Portafanali Bianca

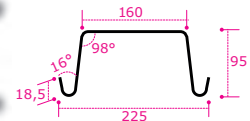

RAL 9016  
LUCIDO  
GLOSSY

ARTICLE	L	H	P	SP	KG	
PB230	2300	230	100	15/10	11,00	1
PB240	2400	230	100	15/10	11,20	1

**i** Attention: to be installed only in presence of approved bumper bar.  
Attenzione: da installare solo in presenza di barra paraincastri omologata.

## Aluminum Lamp Holder Bar

Barra Portafanali Alluminio

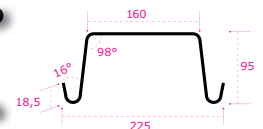

ARTICLE	L	H	P	SP	KG	
P240A20	2400	230	100	20/10	3,13	1

**i** Attention: to be installed only in presence of approved bumper bar.  
Attenzione: da installare solo in presenza di barra paraincastri omologata.



# Bumper Bars

## Anodized Aluminum Bumper Bar Certified ECE 58R.03 with Holes

Barra Portafanali Certificata ECE 58R.03 con Foratura Universale

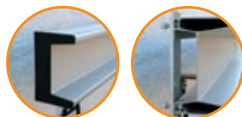
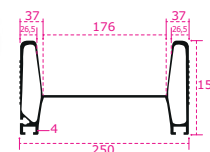

**i** Bumper Bar with with PVC Cap.  
Barra completa di tamponi laterali in PVC.

ARTICLE	L	H	P	KG	
R712051	2400	250	155	23,00	1

In compliance with the legislation ECE 58R.03.  
Conforme alla Normativa ECE 58R.03.

## Anodized Aluminum Bumper Bar Certified ECE 58R.03 without Holes

Barra Portafanali Certificata ECE 58R.03 Senza Fori

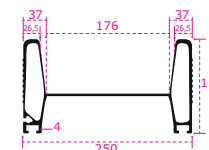

**i** Bumper Bar with with PVC Cap.  
Barra completa di tamponi laterali in PVC.

ARTICLE	L	H	P	KG	
R712051SF	2400	250	155	23,20	1

In compliance with the legislation ECE 58R.03.  
Conforme alla Normativa ECE 58R.03.

## Brackets in Rough Steel for Aluminum Bumper Bar Certified ECE 58R.03

Staffe in Acciaio Grezzo per Barra Portafanali Certificata ECE 58R.03

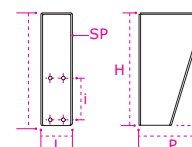

ARTICLE	L	H	P	i	SP	KG	
R714000	135	500	300	220	80/10	40,00	1

## Small Part Kit for Fixing Certified Anodized Aluminum Bumper Bar

Kit Minuteria per Fissaggio Paraurti Alluminio Anodizzato Certificato

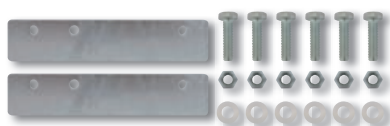

ARTICLE	L	H	P	i	KG	
R713000	295	60	10	220	3,20	1

**i** Kit: 2 Brackets, 6 Bolts D.12x45, 6 Nuts D.12, 6 ABS Washers D.12. Kit composto da: 2 Staffe, 6 Bulloni D.12x45, 6 Dadi D.12, 6 Rondelle ABS D.12.

# Bumper Bars



## Grey Painted Lamp Holder Bar with Riser

Portafanali con Alzata Verniciata Grigia

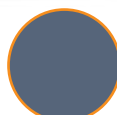
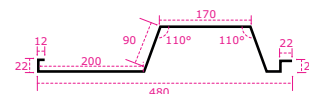

RAL 7015  
LUCIDO  
GLOSSY

**i** Attention: to be installed only in presence of approved bumper bar.  
Attenzione: da installare solo in presenza di barra paraincastri omologata.

ARTICLE	L	H	SP	KG	
R61208	2300	480	15/10	16,90	1
R612081	2400	480	15/10	17,80	1

## Complete Grey Painted Lamp Holder Bar with Riser

Portafanali con Alzata Completa Grigia

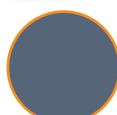
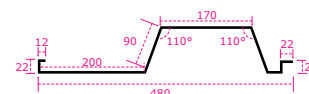

RAL 7015  
LUCIDO  
GLOSSY

**i** Attention: to be installed only in presence of approved bumper bar.  
Attenzione: da installare solo in presenza di barra paraincastri omologata.

ARTICLE	L	H	SP	KG	
R61208C	2300	480	15/10	19,80	1
R612081C	2400	480	15/10	21,60	1

## White Painted Lamp Holder Bar with Riser

Portafanali con Alzata Verniciata Bianca

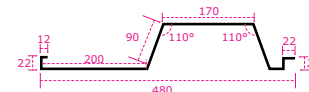

RAL 9016  
LUCIDO  
GLOSSY

**i** Attention: to be installed only in presence of approved bumper bar.  
Attenzione: da installare solo in presenza di barra paraincastri omologata.

ARTICLE	L	H	SP	KG	
R602081F	2300	480	15/10	17,80	1
R60208F	2400	480	15/10	16,90	1

## Complete White Painted Lamp Holder Bar with Riser

Portafanali con Alzata Completa Bianca

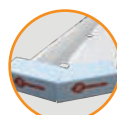
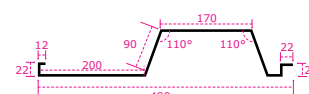

RAL 9016  
LUCIDO  
GLOSSY

**i** Attention: to be installed only in presence of approved bumper bar. Reflecting panels for trailer not included.  
Attenzione: da installare solo in presenza di barra paraincastri omologata. I pannelli riflettenti non sono inclusi.

ARTICLE	L	H	SP	KG	
R602091F	2300	480	15/10	22,30	1
R60209F	2400	480	15/10	22,30	1

# Bumper Bars

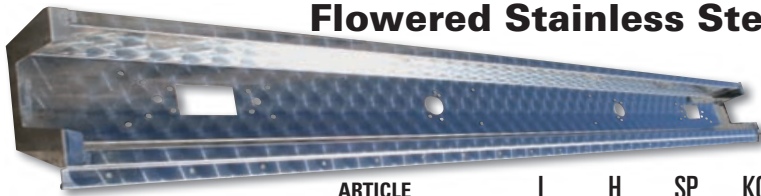

## Flowered Stainless Steel Lamp Holder Bar *Portafanali Inox Fiore*

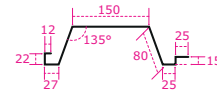

ARTICLE	L	H	SP	KG	
R61219	1900	270	15/10	8,90	1
R61220	2000	270	15/10	9,40	1
R61221	2100	270	15/10	10,00	1

ARTICLE	L	H	SP	KG	
R61222	2200	270	15/10	10,60	1
R61205	2300	270	15/10	11,30	1
R612051	2400	270	15/10	11,60	1

**i** Attention: to be installed only in presence of approved bumper bar. *Attenzione: da installare solo in presenza di barra paraincrastrati omologata.*

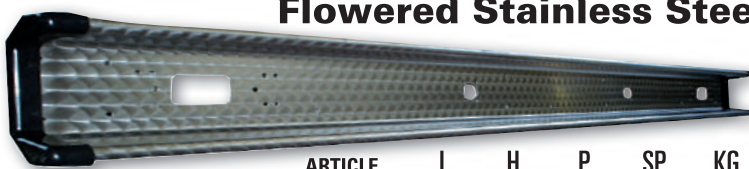

## Flowered Stainless Steel Lamp Holder Bar *Portafanali Inox Fiore*

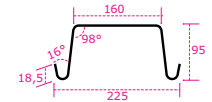

ARTICLE	L	H	P	SP	KG	
R61119	1900	230	100	15/10	8,90	1
R61120	2000	230	100	15/10	9,40	1
R61121	2100	230	100	15/10	10,00	1

ARTICLE	L	H	P	SP	KG	
R61122	2200	230	100	15/10	10,60	1
R61105	2300	230	100	15/10	11,30	1
R611051	2400	230	100	15/10	11,60	1

**i** Attention: to be installed only in presence of approved bumper bar. *Attenzione: da installare solo in presenza di barra paraincrastrati omologata.*

## Complete Flowered Stainless Steel Lamp Holder Bar *Portafanali Inox Fiore Completa*

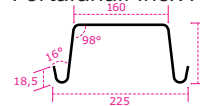
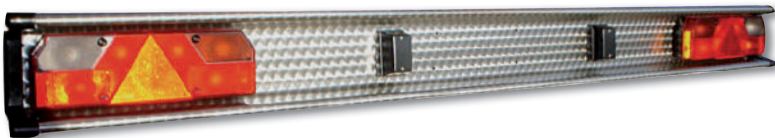

**i** Attention: to be installed only in presence of approved bumper bar. *Attenzione: da installare solo in presenza di barra paraincrastrati omologata.*

ARTICLE	L	H	P	SP	KG	
R61105C	2300	230	100	15/10	12,60	1
R611051C	2400	230	100	15/10	13,10	1

## Flowered Stainless Steel Lamp Holder Bar with Raiser *Portafanali Inox Fiore con Alzata*

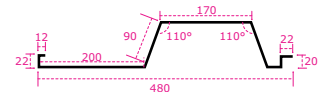
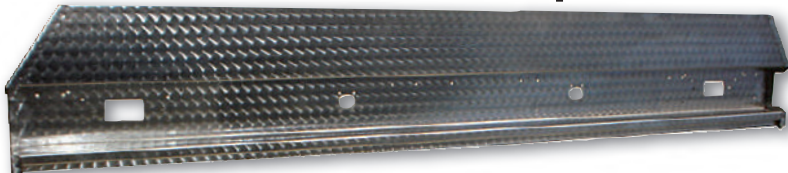

**i** Attention: to be installed only in presence of approved bumper bar. *Attenzione: da installare solo in presenza di barra paraincrastrati omologata.*

ARTICLE	L	H	SP	KG	
R60208	2300	480	15/10	16,20	1
R602081	2400	480	15/10	17,80	1

## Stainless Steel Lamp Holder Bar with Raiser *Portafanali Inox Liscio con Alzata*

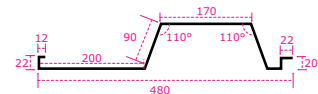

**i** Attention: to be installed only in presence of approved bumper bar. *Attenzione: da installare solo in presenza di barra paraincrastrati omologata.*

ARTICLE	L	H	SP	KG	
R60208120L	2400	480	20/10	24,00	1

## Complete Flowered S. Steel Lamp Holder Bar with Riser *Portafanali Inox F. Completa con Alzata*

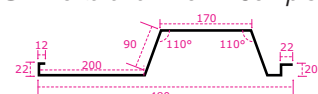
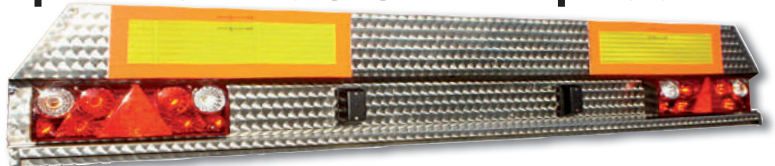

**i** Attention: to be installed only in presence of approved bumper bar. Reflecting panels for trailer not included. *Attenzione: da installare solo in presenza di barra paraincrastrati omologata. I pannelli riflettenti non sono inclusi.*

ARTICLE	L	H	SP	KG	
R60208C	2300	480	15/10	18,30	1
R602081C	2400	480	15/10	18,90	1

# Accessories for Bumper Bars



## PVC Cap for Bumper Bar Quick Installation for Sidemarker Lamp

*Tampone Preforato Inserimento Rapido con Predisposizione Universale per Sidemarker*

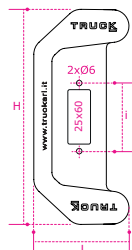

ARTICLE	L	H	i	KG	
C408	105	237	75	0,15	50



**i** Possibility of easily installing all the models of sidemarker present on national and foreign markets.  
*Possibilità di installare facilmente tutti i modelli di sidemarker presenti sul mercato nazionale ed estero.*

## PVC Cap for Bumper Bar Quick Installation

*Tampone Laterale Paraincastri Chiuso Attacco Rapido*

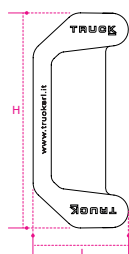

ARTICLE	L	H	KG	
C409	105	237	0,14	50

## Universal PVC Cap for Bumper Bar

*Tampone Laterale Paraincastri Universale*

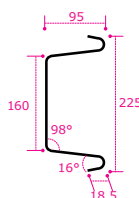

ARTICLE	L	H	KG	
C404	100	230	0,03	50

**i** Automatic insertion to clip.  
*Inserimento automatico a clip.*

## PVC Cap for Bumper Bar

*Tampone Laterale Stretto per Paraincastri*

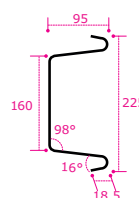

ARTICLE	L	H	KG	
C401	100	230	0,03	50

**i** Insertion with 4 black rivets RIV4814N provided.  
*Inserimento con 4 rivetti RIV4814N neri forniti.*

# Accessories for Bumper Bars



## PVC Cap for Bumper Bar Daily 2000-2020

Tampono Laterale Paraincastri Daily 2000-2020

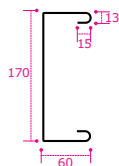

ARTICLE	L	H	KG	
C403	70	175	0,07	50

**i** Insertion with 4 black rivets RIV4814N provided.  
Inserimento con 4 rivetti RIV4814N neri forniti.



## Flowered Stainless Steel Cap for Bumper Bar

Tampono Laterale Acciaio Inox Fiorettato per Paraincastri

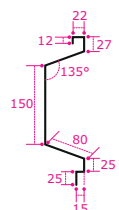

ARTICLE	L	H	SP	KG	
R61205CA	85	255	15/10	0,20	1



## Flowered Stainless Steel Cap for Bumper Bar with Raiser

Tampono Laterale Acciaio Inox Fiorettato per Paraincastri con Alzata

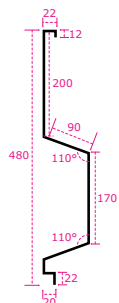

ARTICLE	L	H	SP	KG	
R60208CAD	90	450	15/10	0,40	1
R60208CAS	90	450	15/10	0,40	1

## Stainless Steel Hinge with Holes

Cerniera Inox con Fori

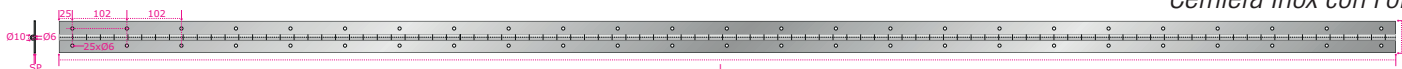

ARTICLE	L	H	SP	KG	
C400	2500	60	20/10	3,30	1

### Black Rivet

Rivetto Nero

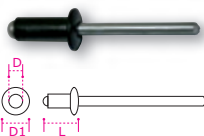

ARTICLE	L	D	D1	KG	
RIV4814N	12	4,8	14	0,01	250

**i** For PVC cap C401-C403.  
Per tampono C401-C403.

### Kit 4 Black Rivets

Set 4 Rivetti Neri

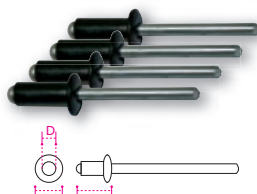

ARTICLE	L	D	D1	KG	
C406	12	4,8	14	0,04	1

**i** For PVC cap C401-C403.  
Per tampono C401-C403.

### Plastic Cap

Tappo Unipress



ARTICLE	Ø Hole Foro	D	KG	
A5	9,5 > 13,5	16	0,002	100

**i** Used to cover wrong holes on mudguards.  
Utilizzato per coprire fori sbagliati su parafanghi.

# Universal License Plates Holder

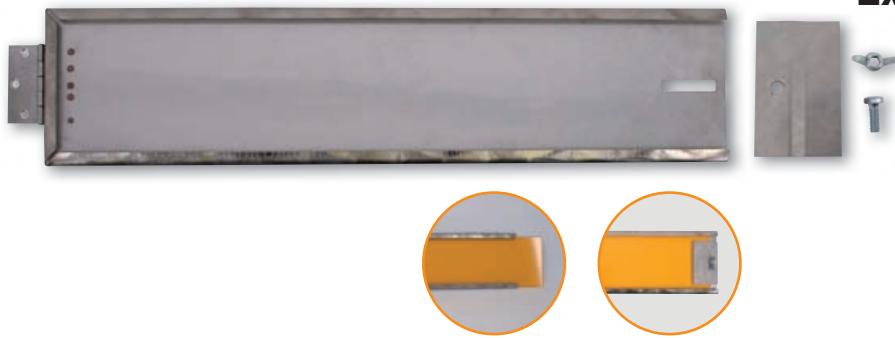

## Extractable Stainless Steel License Plate Holder

*Portatarga Estraibile Inox*

ARTICLE	L	H	SP	KG	
V10046	500	118	8/10	0,60	50
V10045	540	118	8/10	0,60	50

V10045 used for european plates.  
V10045 utilizzata per targhe europee.



## License Plate Repeater

*Targa Ripetitrice*

ARTICLE	L	H	SP	KG	
T90103	480	110	8/10	0,12	1

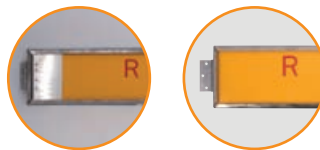

## Adhesive Alphanumeric Characters

*Caratteri Alfanumerici Adesivi*

ARTICLE **T90104** All Letters  
Completo di tutte le lettere



ARTICLE	LETT.	H	
C410	A	78	1
C411	B	78	1
C412	C	78	1
C413	D	78	1
C414	E	78	1
C415	F	78	1
C416	G	78	1
C417	H	78	1
C418	I	78	1

ARTICLE	LETT.	H	
C419	J	78	1
C420	K	78	1
C421	L	78	1
C422	M	78	1
C423	N	78	1
C424	O	78	1
C425	P	78	1
C426	Q	78	1
C427	R	78	1

ARTICLE	LETT.	H	
C428	S	78	1
C429	T	78	1
C430	U	78	1
C431	V	78	1
C432	W	78	1
C433	X	78	1
C434	Y	78	1
C435	Z	78	1
C436	1	78	1

ARTICLE	NUM.	H	
C437	2	78	1
C438	3	78	1
C439	4	78	1
C440	5	78	1
C441	6	78	1
C442	7	78	1
C443	8	78	1
C444	9	78	1
C445	0	78	1

## Extractable License Plate Holder with Spring

*Portatarga Estraibile a Molla*

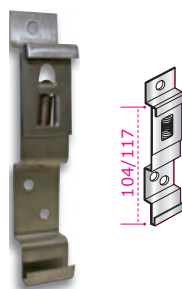

ARTICLE	L	H	SP	KG	
K1000	104	107	15/10	0,31	2

## Plate Fixing Kit

*Kit Fissaggio Targa*



ARTICLE	KG	
E32146	0,02	10

# Universal License Plates Holder



## PVC Black Front License Plate Holder

Portatarga Anteriore Nero

ARTICLE	DESCRIPTION	L	H	KG	
E30323	Pvc Pvc	375	125	0,18	100
E30323P	Pvc Customized Pvc Personalizzato	375	125	0,18	100
C35001	Customized cliché Clichè personalizzato				

**i** Customizable area 244x13 mm (LxH). Minimum order 100 pieces.  
Spazio personalizzabile 244x13 mm. (LxH). Ordine minimo 100 pezzi.

## Black Front License Plate Holder

Portatarga Anteriore Nero



ARTICLE	DESCRIPTION	L	H	KG	
E30339	Painted Sheet Lamiera Verniciata	375	125	0,15	100

**i** Not customizable. Minimum order 100 pieces.  
Non personalizzabile. Minimo d'ordine 100 pezzi.

## Aluminium Front License Plate Holder

Portatarga Anteriore Alluminio



ARTICLE	DESCRIPTION	L	H	KG	
E30326	Gray Anodized Alum. Allum. Anod. Grigio	375	125	0,15	100

**i** Not customizable. Minimum order 100 pieces.  
Non personalizzabile. Minimo d'ordine 100 pezzi.

## Black Rear License Plate Holder

Portatarga Posteriore Nero

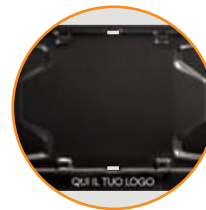
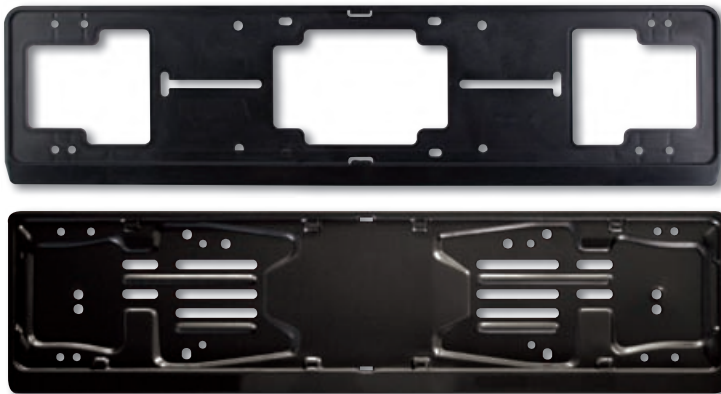

ARTICLE	DESCRIPTION	L	H	KG	
E30331	Pvc Pvc	535	135	0,08	100
E30331P	Pvc Customized Pvc Personalizzato	535	135	0,08	100

C35001 Customized cliché Clichè personalizzato

**i** Customizable area 413x13 mm (LxH). Minimum order 100 pieces.  
Spazio personalizzabile 413x13 mm. (LxH). Ordine minimo 100 pezzi.

ARTICLE	DESCRIPTION	L	H	KG	
E30341	Painted Sheet Lamiera Verniciata	535	135	0,10	100
E30341P	Painted Sheet Lamiera Verniciata	535	135	0,10	100

C35001 Customized cliché Clichè personalizzato

## Aluminium Rear License Plate Holder

Portatarga Posteriore Alluminio



ARTICLE	L	H	KG	
E30332	535	135	0,10	100
E30332P	535	135	0,10	100

C35001 Customized cliché Clichè personalizzato

**i** Customizable area 413x13 mm (LxH). Minimum order 100 pieces.  
Spazio personalizzabile 413x13 mm. (LxH). Ordine minimo 100 pezzi.

# Protective Grills

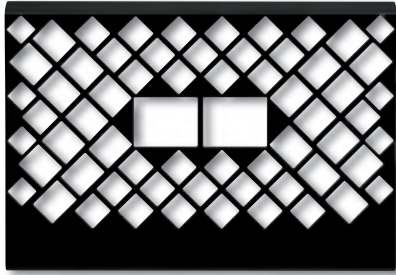

## Black Painted Protective Grills for Iveco Daily 2021

Griglia Parasassi Iveco Daily 2021 Verniciata Nera

ARTICLE	L	H	SP	KG	
V10212	320	225	15/10	0,60	1



The application on the bar has been designed to speed up the operator's work, respecting the section of the bar and the functions of the rear lamp. Quick change and replacement of the rear light and bulbs.  
Il concetto dell'applicazione sulla barra è stato studiato per velocizzare il lavoro dell'operatore, rispettando la sezione della barra e le funzioni del fanale. Rapido cambio e sostituzione del fanale e delle lampadine.

## Protective Grills for New Daily

Griglia Parasassi New Daily

ARTICLE	L	H	SP	KG	
V10200	330	195	4/10	0,55	1

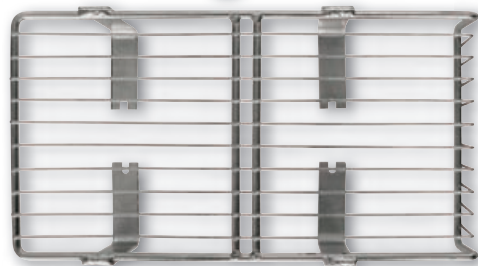

## Protective Grills for Daily dal 2000 al 2020

Griglia Parasassi Daily dal 2000 al 2020

ARTICLE	L	H	SP	KG	
V10201	375	195	4/10	1,08	1



## Protective Grills for Ford Transit <2017

Griglia Parasassi Ford Transit <2017

ARTICLE	L	H	SP	KG	
V102300	370	195	4/10	0,77	1



## Protective Grills for Ford Transit >2017

Griglia Parasassi Ford Transit >2017

ARTICLE	L	H	SP	KG	
V20130	420	130	4/10	0,90	1

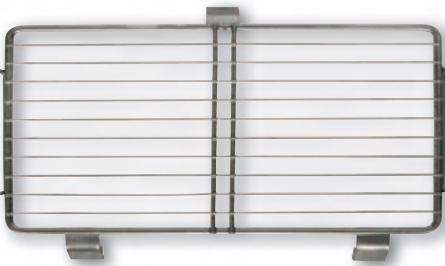

## Protective Grills for Nissan Cabstar

Griglia Parasassi Nissan Cabstar

ARTICLE	L	H	SP	KG	
V10220	370	195	4/10	0,66	1



## Protective Grills for Bumper Bar

Griglia Parasassi Attacco Barra

ARTICLE	L	H	SP	KG	
V10202	490	195	4/10	1,00	1



Possibility to realize grills for any vehicle and brand by specific request.  
Possibilità di realizzare su specifica richiesta griglie per qualsiasi mezzo e marca.



# Ladders

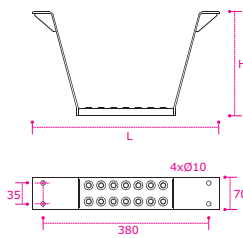

## Galvanized Step

*Gradino Zincato*

ARTICLE	L	H	KG	
R10110	405	240	1,25	10

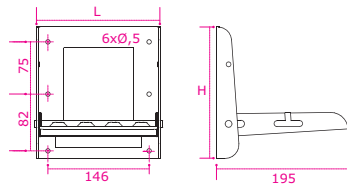

## Retractable Platform

*Pedana di Salita Retrattile*

ARTICLE	L	H	KG	
R11111	172	190	1,20	10

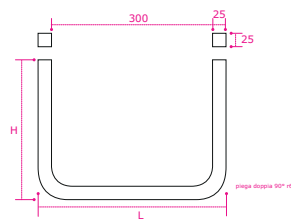

## Stainless Steel Step

*Gradino di Salita Inox*

ARTICLE	L	H	SP	KG	
R10109	350	260	20/10	0,86	1

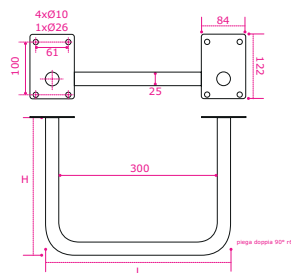

## Stainless Steel Step with Inwards Plate

*Gradino di Salita Inox con Staffe Interne*

ARTICLE	L	H	SP	KG	
R10107	350	260	20/10	0,95	1

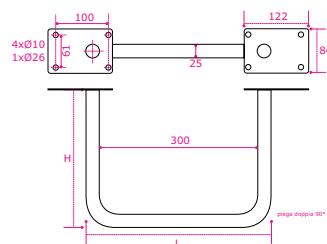

## Stainless Steel Step with Outwards Plate

*Gradino di Salita Inox con Staffe Esterne*

ARTICLE	L	H	SP	KG	
R10108	350	260	20/10	0,95	1

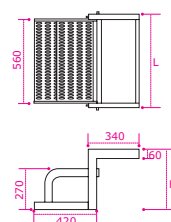

## Galvanized Retractable Ladder

*Scaletta di salite Retrattile Zincata*

ARTICLE	L	H	P	KG	
V30054	620	330	340	37,50	1

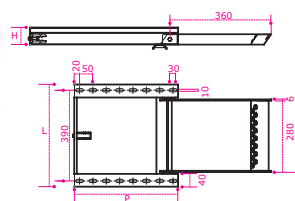

## Galvanized Extractable Ladder One Step

*Scaletta Zincata Estraibile Un Gradino*

ARTICLE	L	H	P	KG	
V10050	420	60	370	4,50	10

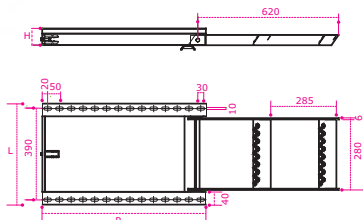

## Galvanized Extractable Ladder Two Steps

*Scaletta Zincata Estraibile Due Gradini*

ARTICLE	L	H	P	KG	
V10051	420	60	660	7,60	10

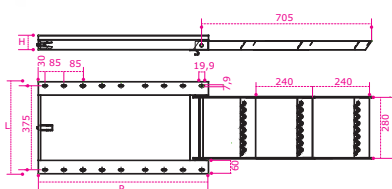

## Galvanized Extractable Ladder Three Steps

*Scaletta Zincata Estraibile Tre Gradini*

ARTICLE	L	H	P	KG	
V100510	420	60	750	8,50	10

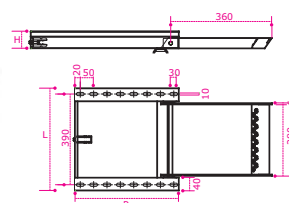

## Stainless Steel Extractable Ladder One Step

*Scaletta Inox Estraibile Un Gradino*

ARTICLE	L	H	P	KG	
IF10050	420	60	370	4,50	10

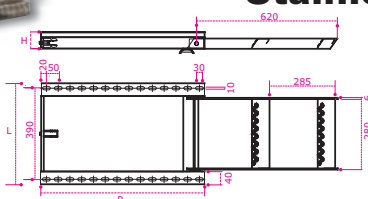

## Stainless Steel Extractable Ladder Two Steps

*Scaletta Inox Estraibile Due Gradini*

ARTICLE	L	H	P	KG	
IF10051	420	60	660	7,60	10

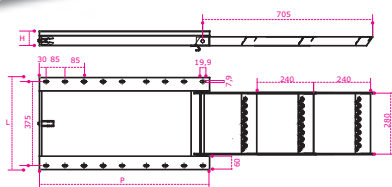

## Stainless Steel Extractable Ladder Three Steps

*Scaletta Inox Estraibile Tre Gradini*

ARTICLE	L	H	P	KG	
IF100510	420	60	750	8,50	10

## Connecting Clip For Ladder

*Clip Innesto per Scaletta*



ARTICLE	L	H	P	D	D1	KG	
V10056	53	31	25	14	6,5	0,024	1

## Tread Sliding Rail For Ladder

*Rotaia Scorrimento Pedata per Scaletta*

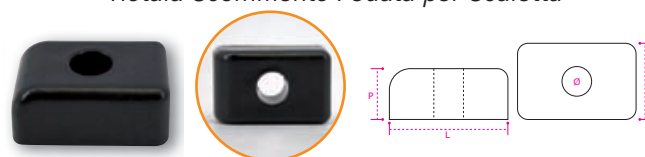

ARTICLE	L	H	P	D	KG	
V168680	56	36	24	14	8,50	1

# Ladders



## Galvanized Extractable Ladder Two Steps with Platform

*Scaletta Zincata Estraibile Due Gradini con Pedana*

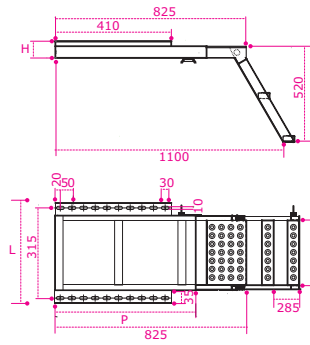
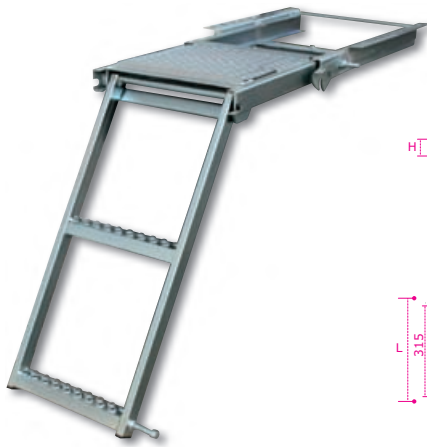

ARTICLE	L	H	P	KG	
R30270	380	60	530	8,70	1

## Galvanized Extractable Ladder Four Steps

*Scaletta Zincata Estraibile Quattro Gradini*

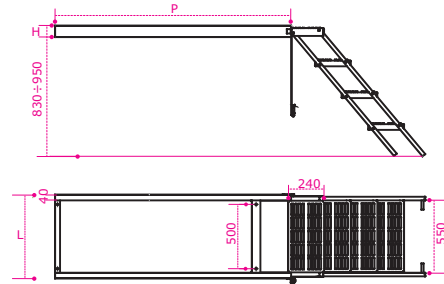
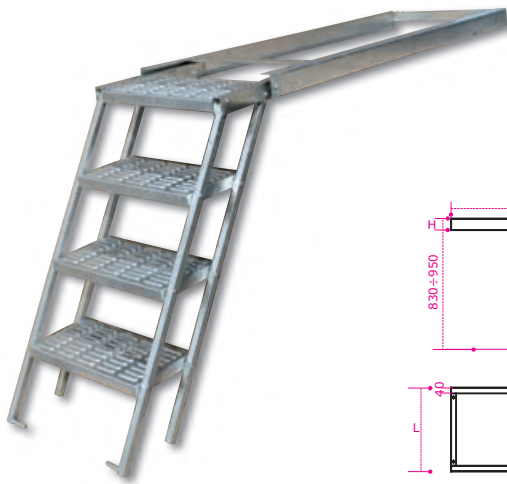

ARTICLE	L	H	P	KG	
V30050	635	80	1780	36,50	1

## Galvanized Extractable Ladder Five Steps

*Scaletta Zincata Estraibile Cinque Gradini*

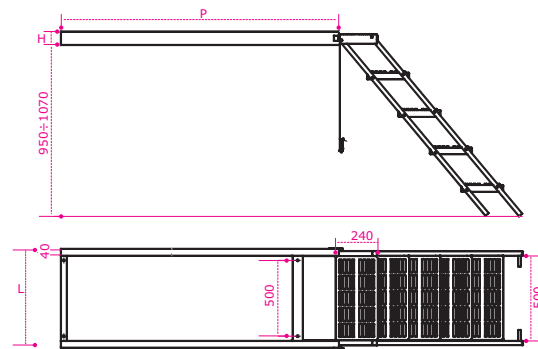
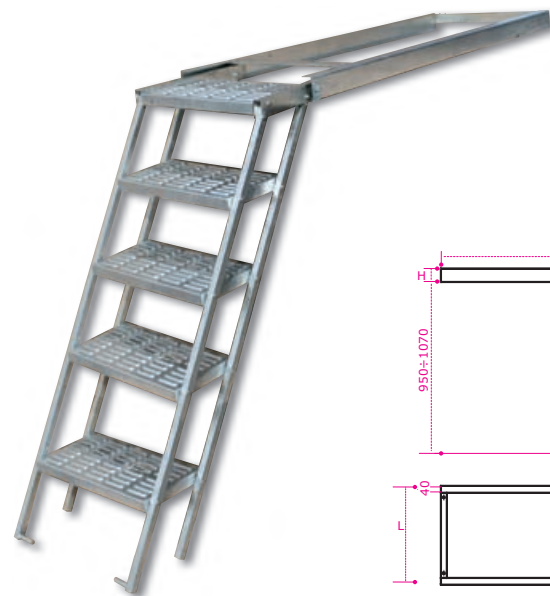

ARTICLE	L	H	P	KG	
V30051	635	80	2060	42,50	1

# Body Mounting Brackets



## Raw Body Mounting Bracket

*Supporto Grezzo Standard*

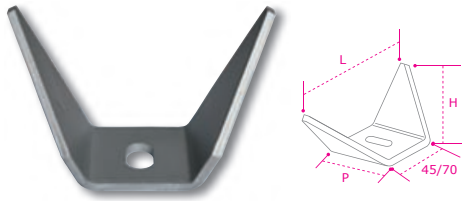

ARTICLE	L	H	P	SP	KG	
R13105	126	74	60	5	0,3	100
R1310	150	100	60	6	0,5	100
R13111	170	84	60	10	0,85	100

## Raw Light Body Mounting Bracket

*Supporto Grezzo Leggero*

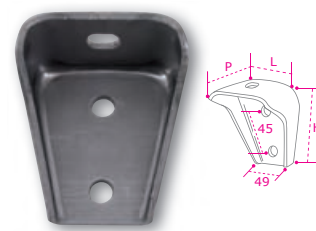

ARTICLE	L	H	P	SP	KG	
R13100	80	90	52	5	0,33	100

## Raw Light Body Mounting Bracket Reinforced

*Supporto Grezzo Leggero Modello Rinforzato*

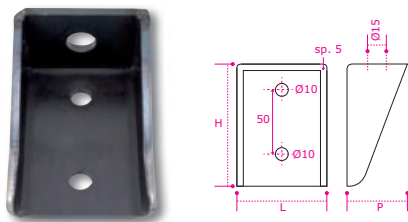

ARTICLE	L	H	P	SP	KG	
R17131	70	95	50	5	0,54	100

TKcert RINA UNI EN ISO 15614-1:2012

## Raw Body Mounting Bracket for Eurocargo

*Supporto Grezzo Eurocargo*

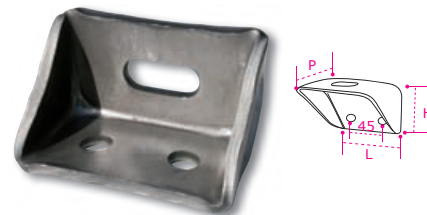

ARTICLE	L	H	P	SP	KG	
R13107	108	60	60	6	0,63	100

## Raw Heavy Body Mounting Bracket

*Supporto Grezzo Pesante*

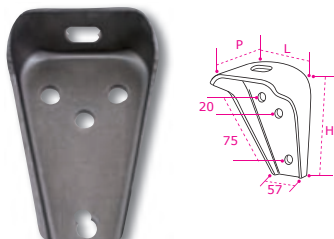

ARTICLE	L	H	P	SP	KG	
R13101	113	158	60	6	0,97	100

## Raw Sliced Heavy Body Mounting Brackets

*Supporto Pesante Grezzo Tranciato*

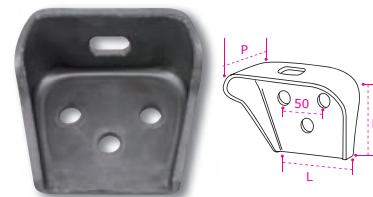

ARTICLE	L	H	P	SP	KG	
R13103	113	95	81	6	0,72	100

## Raw Body Mounting Bracket

*Supporto Grezzo Falso Telaio*

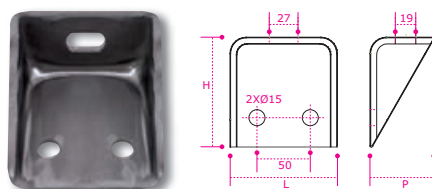

ARTICLE	L	H	P	SP	KG	
R78100	100	105	60	7	0,90	100

## Raw Body Mounting Bracket with Transversal Slot

*Supporto Grezzo Falso Telaio con Asola Trasversale*

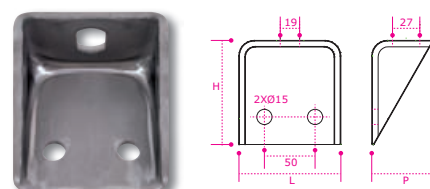

ARTICLE	L	H	P	SP	KG	
R78200	100	105	60	7	0,90	100

# Body Mounting Brackets

## Body Mounting Brackets Kit with Spring

*Kit Falso Telaio con Molla Assemblato*

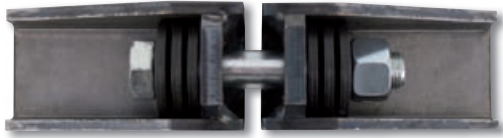

### Raw Body Mounting Brackets for Volvo

*Supporto Volvo Grezzo*



TKcert RINA UNI EN ISO 15614-1:2012

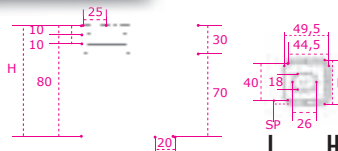

ARTICLE	L	H	SP	KG	
R17130	50	100	5	0,65	1

## Body Mounting Brackets Kit for Scania e Volvo

*Kit Falso Telaio Scania e Volvo*

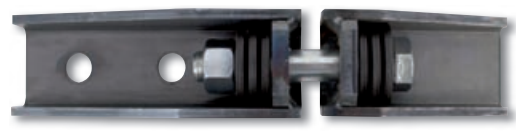

### Raw Body Mounting Brackets for Scania

*Supporto Scania Grezzo*



TKcert RINA UNI EN ISO 15614-1:2012

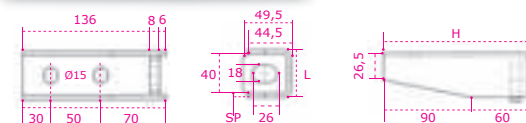

ARTICLE	L	H	SP	KG	
R17132	50	150	5	0,79	1

### Raw Body Mounting Brackets without holes

*Supporto Universale Senza Fori*



TKcert RINA UNI EN ISO 15614-1:2012

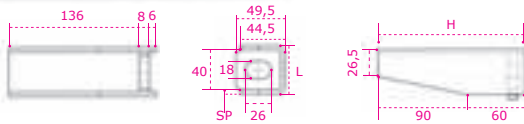

ARTICLE	L	H	SP	KG	
R17132SF	50	150	5	0,80	1

### Raw Body Mounting Brackets for MAN

*Supporto Falso Telaio Mod. MAN*



TKcert RINA UNI EN ISO 15614-1:2012

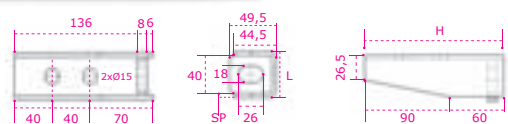

ARTICLE	L	H	SP	KG	
R17137	50	150	5	0,79	1

### Raw Body Mounting Brackets

*Supporto Man Grezzo*

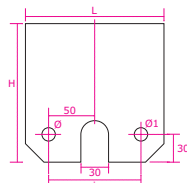

ARTICLE	L	H	i	SP	KG	
R17129	150	150	100	8	1,17	1

### Fixing Support Chassis 3/5

*Supporto Fissaggio Chassis 3/5*

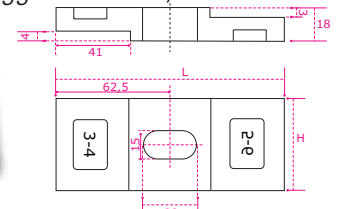

ARTICLE	L	H	KG	
R17134	125	50	0,64	1

### Fixing Support Chassis *Supp. Fissaggio Chassis*

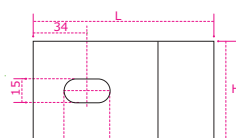
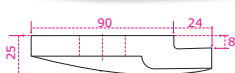

ARTICLE	L	H	KG	
R17135	114	62	0,62	1

### Fixing Support Chassis *Supp. Fissaggio Chassis*

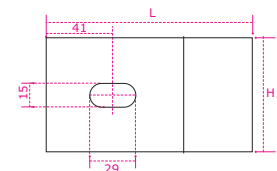

ARTICLE	L	H	KG	
R17136	130	72	0,88	1

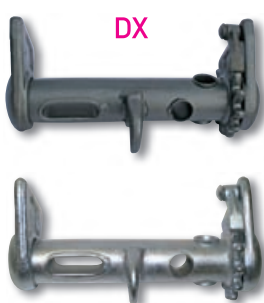
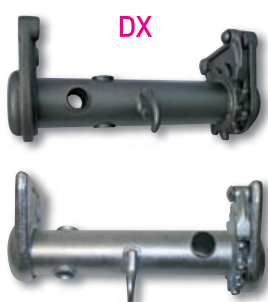
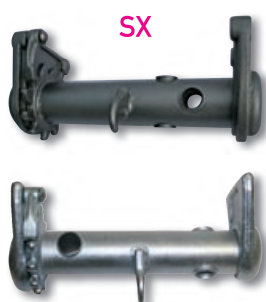
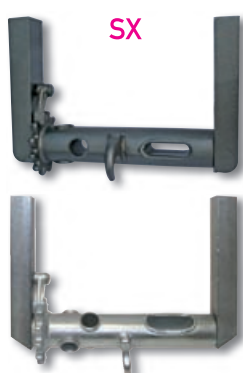

## Winch Ø42

Verricello Ø42

ARTICLE	DIR	D	L	H	KG	
R27104	DX	42	200	180	1,85	12
R27103	SX	42	200	180	1,85	12
R27104Z Galvanized Zincato	DX	42	200	180	1,85	12
R27105Z Galvanized Zincato	SX	42	200	180	1,85	12

## Raw Winch with Reinforced Bracket

Verricello Grezzo Rinforzato con Staffe

ARTICLE	DIR	D	L	H	KG	
R27106	DX	48	230	190	2,10	12
R27107	SX	48	230	190	2,10	12
R27110	DX	60	280	195	3,50	12
R27111	SX	60	280	195	3,0	12
R27106Z Galvanized Zincato	DX	48	230	190	2,20	12
R27107Z Galvanized Zincato	SX	48	230	190	2,20	12

## Raw Winch with Bracket and Slot

Verricello Grezzo con Staffe e Asola

ARTICLE	DIR	D	L	H	KG	
R27108	DX	48	250	190	2,20	12
R27109	SX	48	250	190	2,20	12
R27124	DX	60	280	195	3,60	12
R27105	SX	60	280	195	3,60	12
R27108Z Galvanized Zincato	DX	48	250	190	2,20	12
R27109Z Galvanized Zincato	SX	48	250	190	2,20	12

## Raw Winch Printed Surface

Verricello Grezzo Facce Stampate

ARTICLE	DIR	D	L	H	KG	
R27114	DX	48	190	108	2,50	12
R27115	SX	48	190	108	2,50	12
R27118	DX	60	250	132	5,40	12
R27119	SX	60	250	132	5,40	12
R27114Z Galvanized Zincato	DX	48	190	108	2,50	12
R27115Z Galvanized Zincato	SX	48	190	108	2,50	12

## Raw Winch Printed Surface and Slot

Verricello Grezzo Facce Stampate e Asola

ARTICLE	DIR	D	L	H	KG	
R27116	DX	48	225	108	2,70	12
R27117	SX	48	225	108	2,70	12
R27120	DX	60	250	132	5,40	12
R27121	SX	60	250	132	5,40	12
R27116Z Galvanized Zincato	DX	48	225	108	2,70	12
R27117Z Galvanized Zincato	SX	48	225	108	2,70	12

# Hooks



**Light Rope Tightener**  
*Tendifune Leggero*

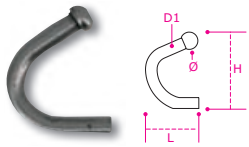

ARTICLE	L	H	D	D1	KG	
Raw/Grezzo						
R12121	37	53	12	8	0,04	1
Stainless Steel/Acciaio Inox						
R00500	37	53	12	8	0,04	1

**Light Rope Tightener**  
*Tendifune Leggero*

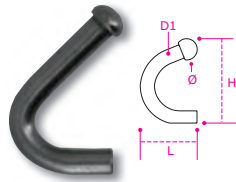

ARTICLE	L	H	D	D1	KG	
R12117	40	60	14	10	0,06	1

**Light Rope Tightener**  
*Tendifune Leggero*

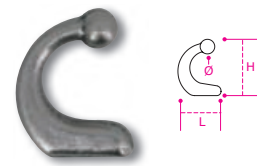

ARTICLE	L	H	D	KG	
R12120	41	54	13	0,08	1

**Medium Rope Tightener**  
*Tendifune Medio*

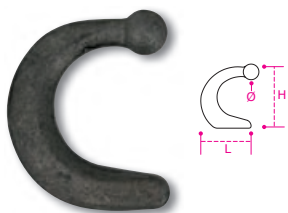

ARTICLE	L	H	D	KG	
R12118	48	61	15	0,10	1

**Heavy Rope Tightener**  
*Tendifune Pesante*



ARTICLE	L	H	D	KG	
R12122	72	76	17	0,25	1

**Light Towing Hook**  
*Gancio Traino Leggero*

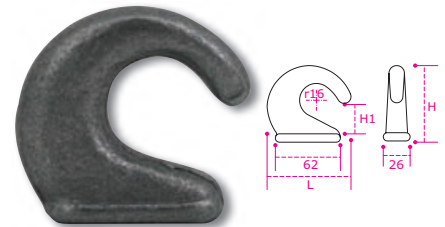

ARTICLE	L	H	H1	KG	
R12136	80	73	24	0,43	1

**Medium Towing Hook**  
*Gancio Traino Medio*

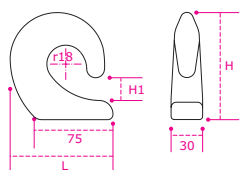

ARTICLE	L	H	H1	KG	
R12119	98	102	20	1,00	1

**Heavy Towing Hook**  
*Gancio Traino Pesante*

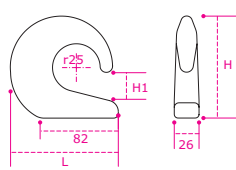

ARTICLE	L	H	H1	KG	
R12137	113	107	30	0,94	1

**Most Heavy Towing Hook**  
*Gancio Traino Pesantissimo*

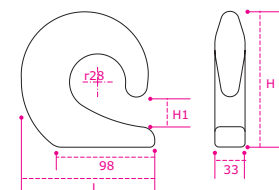

ARTICLE	L	H	H1	KG	
R12138	133	135	30	2,00	1

# Light Hinges

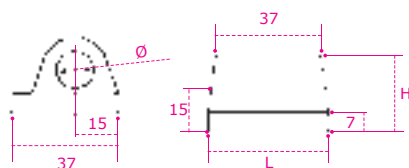
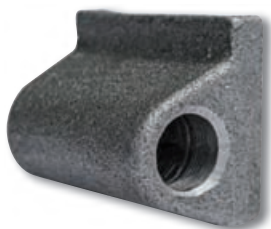

## Raw Hinge Ø12,5

*Cerniera Grezza Ø12,5*

ARTICLE	L	H	D	KG	
R15102	42	26,5	12,5	0,16	100

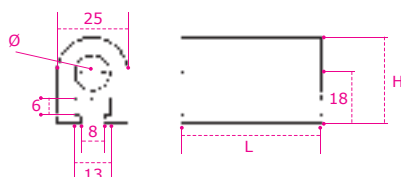

## Aluminum Hinge Ø12,5

*Cerniera Alluminio Ø12,5*

ARTICLE	L	H	D	KG	
R17126	49	30,5	12,5	0,05	100

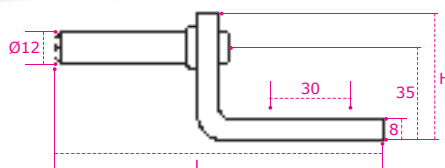

## Galvanized Pivot Ø12

*Perno Lamiera Zincata Ø12*

ARTICLE	L	H	SP	KG	
R15100	120	48	8	0,20	100

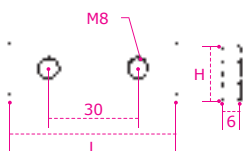

## Galvanized Plate

*Piastrina Zincata*

ARTICLE	L	H	SP	KG	
R15103	56	18	6	0,04	100



## Hexagon Cylindrical Screw

*Vite Cilindrica Esagono*

ARTICLE	L	H	PA	KG	
000457	20	8	1,25	0,01	200
000458	25	8	1,25	0,01	200



# Light Tir Hinges

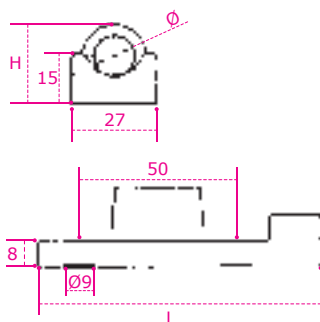

## Light Tir Hinge

*Cerniera Tir Leggera*

ARTICLE	L	H	D	KG	
R15105 Raw Grezza	90	25	13	0,21	100
R17123 Galvanized Zincata	90	25	13	0,21	100
R17124 Stainless Steel Inox	90	25	13	0,21	100

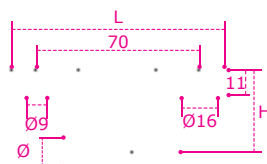

## Light Tir Pivot

*Perno Tir Leggero*

ARTICLE	L	H	D	KG	
R15104 Galvanized Zincato	92	35	12	0,23	100
R17125 Stainless Steel Inox	92	35	12	0,21	100

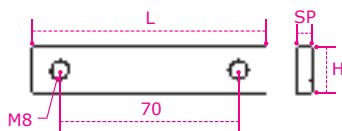
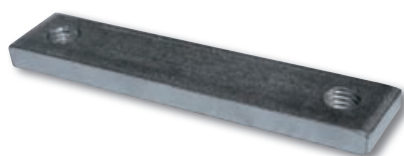

## Galvanized Plate

*Piastrina Zincata*

ARTICLE	L	H	SP	KG	
R15110	92	18	6	0,07	100

## Hexagon Screw

*Vite Testa Svasata Esagono*



ARTICLE	L	M	PA	KG	
000615	20	8	1,25	0,01	200

## Hexagon Cylindrical Screw

*Vite Cilindrica Esagono*



ARTICLE	L	M	PA	KG	
000456	16	8	1,25	0,01	200

# Heavy Tir Hinges

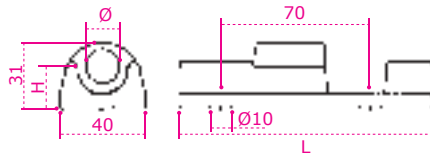

## Heavy Tir Hinge H20

*Cerniera Tir Pesante H20*

ARTICLE	L	H	D	KG	
R17120 Raw Grezza	120	20	16	0,43	100
R17121 Galvanized Zincata	120	20	16	0,43	100
R17122 Stainless Steel Inox	120	20	16	0,43	100

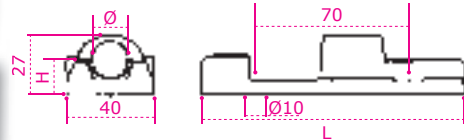

## Heavy Tir Hinge H16

*Cerniera Tir Pesante H16*

ARTICLE	L	H	D	KG	
R17118 Raw Grezza	120	16	16	0,40	100
R17119 Galvanized Zincata	120	16	16	0,40	100

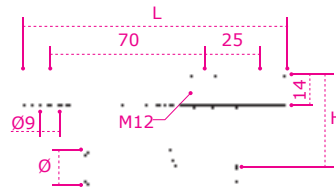

## Heavy Tir Pivot Ø15

*Perno Tir Pesante Ø15*

ARTICLE	L	H	D	SP	KG	
R17117 Galvanized Zincato	120	42	15	14	0,44	100
R90310 S. Steel Inox	120	42	15	14	0,41	100

## Galvanized Plate with Hole

*Piastrina Zincata con Foro*

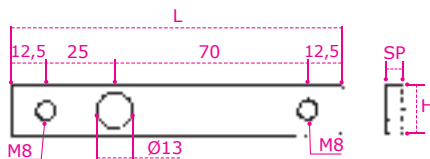

ARTICLE	L	H	SP	KG	
R17116	120	18	6	0,10	100

## Galvanized Plate

*Piastrina Zincata*

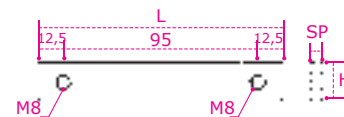

ARTICLE	L	H	SP	KG	
R16110	120	18	6	0,10	1

# Hinges for Tipper



## Dropside Hinge

*Cerniera Sponda Ribaltabile*

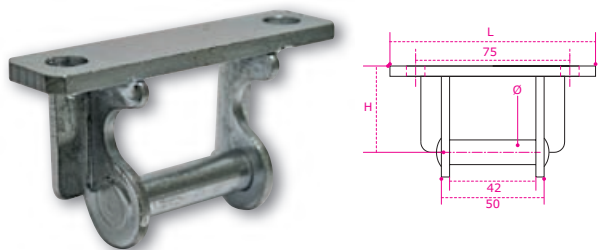

ARTICLE	L	H	D	KG	
R27136	100	42	12	0,20	1

## Support for Bar

*Supporto Barra*

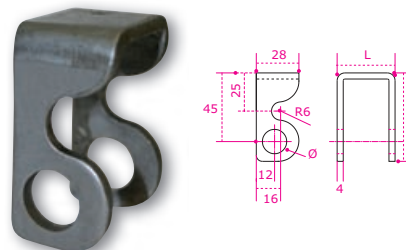

ARTICLE	L	H	D	KG	
R27138	38	58	16	0,08	1

## Light Plate for Hinge

*Paletta Leggera*

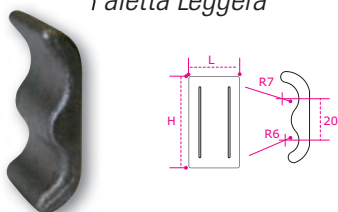

ARTICLE	L	H	D	KG	
R15112	25	45	12	0,03	1

## Galvanized Plate

*Piastrina Zincata*



ARTICLE	L	H	SP	KG	
R15110	92	18	6	0,07	100

## Dropside Hinge Ø25

*Cerniera Sponda Ribaltabile Ø25*

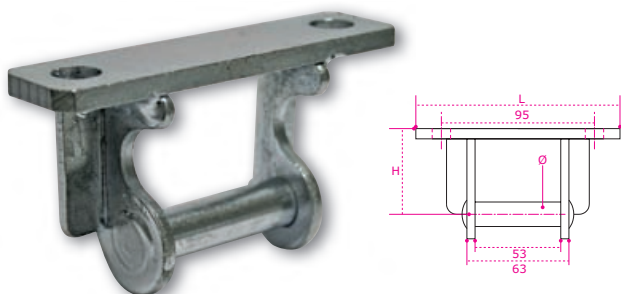

ARTICLE	L	H	D	KG	
R17142	118	52	14	0,33	1

## Support for Bar

*Supporto Barra*

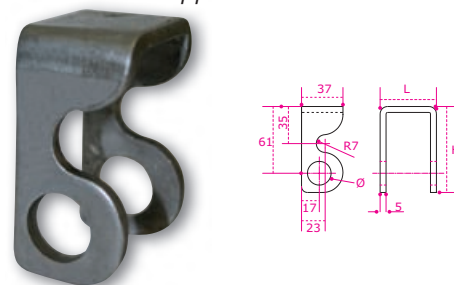

ARTICLE	L	H	D	KG	
R17143	46	79	21	0,21	1

## Medium Plate

*Paletta Media*

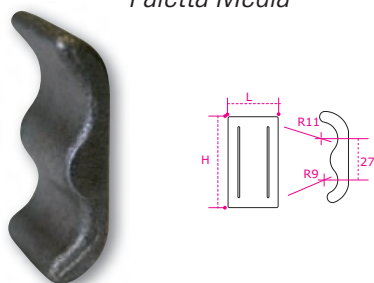

ARTICLE	L	H	D	KG	
R17144	33	60	14	0,12	1

## Galvanized Plate

*Piastrina Zincata*

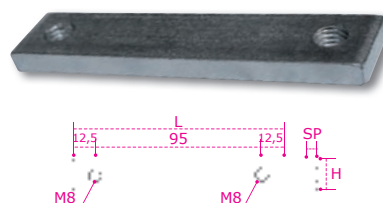

ARTICLE	L	H	SP	KG	
R16110	120	18	6	0,10	1



## Trilateral TR5 Hinge for Dropside

*Cerniera Sponda TRILATERALE TR5*

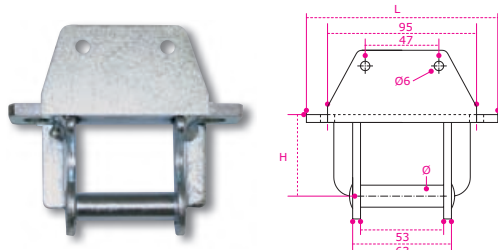

ARTICLE	L	H	D	KG	
R37146	122	52	14	0,57	1

## Support for Bar

*Supporto Barra*

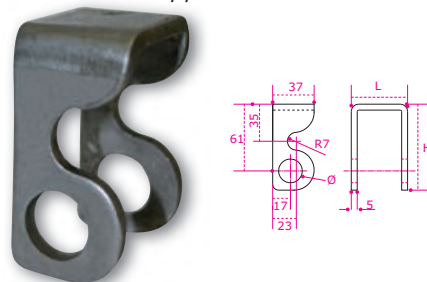

ARTICLE	L	H	D	KG	
R17143	46	79	21	0,21	1

## Medium Plate

*Paletta Media*



ARTICLE	L	H	D	KG	
R17144	33	60	14	0,12	1

## Galvanized Plate

*Piastrina Zincata*

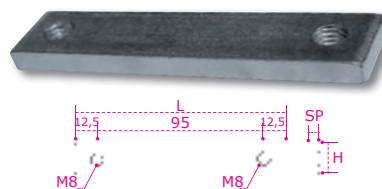

ARTICLE	L	H	SP	KG	
R16110	120	18	6	0,10	1

## Light Hook for Door Retainer with Hole Ø21

*Saltarello Leggero con foro Ø21*

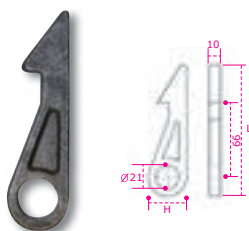

ARTICLE	L	H	KG	
R20175	117	34	0,15	1

## Light Hook for Door Retainer with Hole Ø22

*Saltarello Medio con foro Ø22*

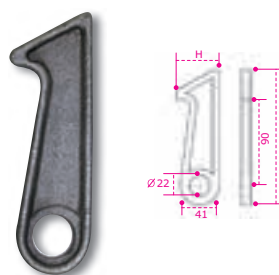

ARTICLE	L	H	KG	
R20178	142,5	45	0,24	1

## Heavy Hook for Door Retainer with Hole Ø26

*Saltarello pesante con foro Ø26*

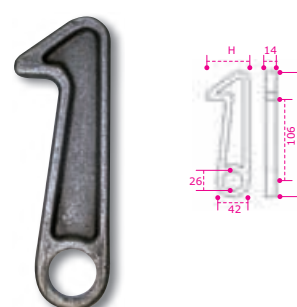

ARTICLE	L	H	KG	
R20176	164	55	0,42	1

## Hook for Lever Retainer

*Saltarello Ferma Leva*

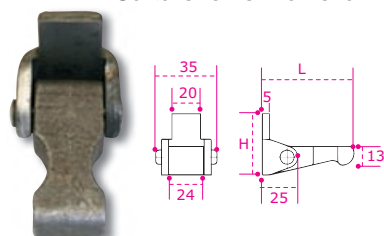

ARTICLE	L	H	KG	
R16221	65	43	0,21	1

## Strike Plate for Hook For Door Retainer

*Riscontro per Saltarello*

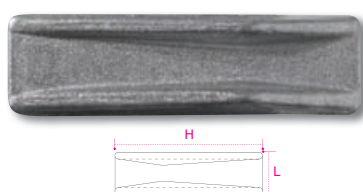

ARTICLE	L	H	KG	
R37144	40	140	0,38	1

## Latch with Spring

*Chiavistello con Molla*

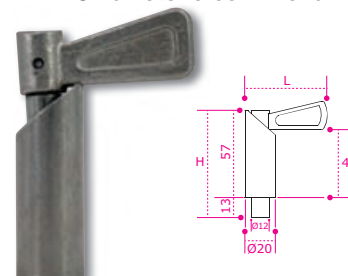

ARTICLE	L	H	KG	
R44890	53	70	0,15	1

# Accessories for Tipper

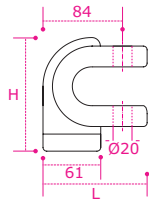

## Dumper Latch Ø40

Chiusura Dumper Ø40

ARTICOLO	L	H	D	KG	
R132239	110	120	20	2,27	1

## Pivot for Dumper Latch

Spina per Chiusura Dumper

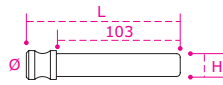

ARTICLE	L	H	D	KG	
R132237	128	18	19	0,13	100

## Column for Dumper Latch Ø40

Piantone Dumper Ø40

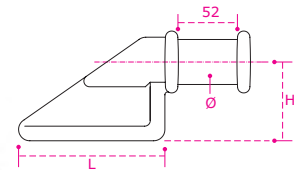

ARTICLE	DIR	L	H	D	KG	
R132250	SX	130	70	40	2,30	1
R132240	DX	130	70	40	2,30	1

## Raw Heavy Rear Hinge

Cerniera grezza post. pesante

## Raw Latch for Hinge

Chiusura grezza per cerniera

## Raw Heavy Pivot Ø12

Spinotto grezzo pesante Ø12

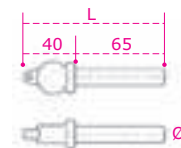
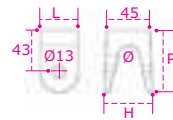
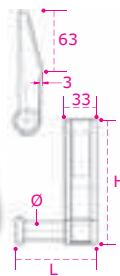
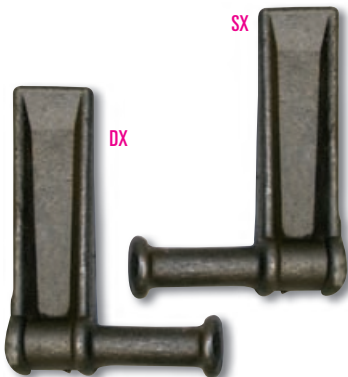

ARTICLE	DIR	L	H	D	KG	
R16011	SX	85	127	19	0,51	1
R16012	DX	85	127	19	0,51	1

ARTICLE	L	H	P	D	KG	
R16016	40	51	65	22	0,40	1

ARTICLE	L	D	KG	
R16020	105	12	0,13	1

## Block Lock

Chiusura a Blocco

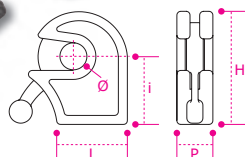

ARTICLE	L	H	P	D	i	KG	
R30085	50	85	25	21	50	0,64	1
R51100	62	115	39	25	70	1,54	1

## Pins for Block Lock

Piantone per Chiusura a Blocco

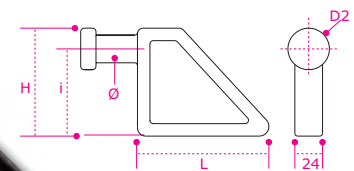

ARTICLE	L	H	D	D2	i	KG	
R30185	91	76	20	29	60	0,90	1
R80100	128	110	24	32	95	1,35	1

# Accessories for Tipper



## Tank Rear Door Lock Assembly

*Chiusura Carro Botte "Export"*

ARTICLE	L	H	D	KG	
R132246	180	38	20	1,45	1

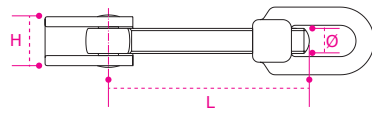

## Locking Bracket for Tank Rear Door Lock Assembly

*Staffa Bloccaggio per Carro Botte*



ARTICLE	L	H	D	KG	
R132243	155	48	20	0,56	1

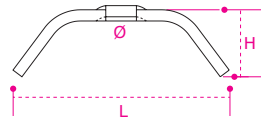

## Rear Door Hinge

*Cerniera Apertura a Libro*

ARTICLE UPPER SUPERIORE	ARTICLE LOWER INFERIORE	L	H	D	KG UPPER SUPERIORE	KG LOWER INFERIORE	
R52720	R52710	179	179	35	2,60	1,30	1
R03210	R03220	174	174	40	3,50	1,80	1
R03230	R03240	216	216	50	6,60	3,50	1
R03250	R03260	268	194	76	14,90	7,90	1

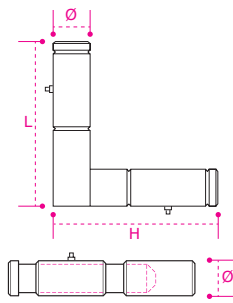

## Sphere Kit for Tipper

*Kit Sfere per Ribaltabili*



ARTICLE	L	L1	H	H1	D	D1	KG	
R03270	91	194	70	52	60	18	10,40	1
R03271	116	220	74	75	75	18	21,50	1
R03273	135	251	87,5	58	85	24	29,50	1
R03274	152	265	92	83	95	24	44,30	1
R03275	170	293	112	108	110	30	71,40	1

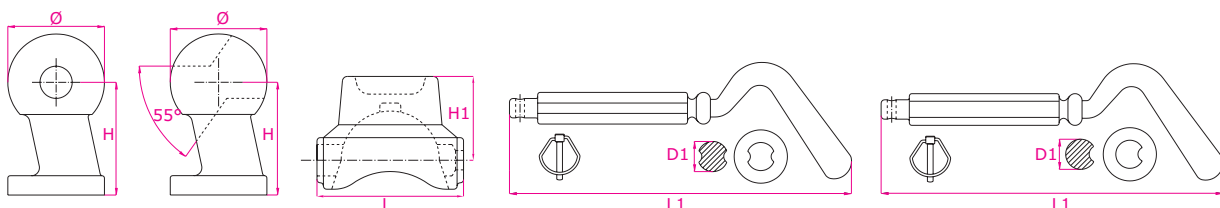

# Spheres Kit for Tipper



## Sphere with Slot

Sfera con asola



ARTICLE	DIR	ARTICLE	DIR	D	L	H	KG	
R14003	SX	R14002	DX	60	60	70	1,20	1
R14015	SX	R14014	DX	75	76	74	2,20	1
R14034	SX	R14033	DX	85	90	87,5	3,10	1
R14047	SX	R14044	DX	95	110	92	4,60	1
R14054	SX	R14053	DX	110	126	112	7,40	1

## Sphere with Hole

Sfera un foro



ARTICLE	D	L	H	DIR	KG	
R14001	60	60	70	DX-SX	1,30	1
R14013	75	74	74	DX-SX	2,40	1
R14032	85	87,5	87,5	DX-SX	3,40	1
R14043	95	92	92	DX-SX	5,00	1
R14052	110	112	112	DX-SX	8,00	1

## Socket for Sphere

Chiocciola per sfera

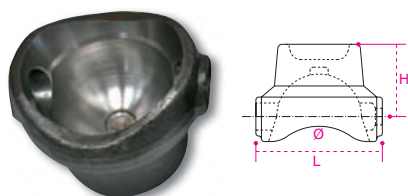

ARTICLE	D	L	H	DIR	KG	
R14000	60	91	52	R-L/DX-SX	1,25	1
R14011	75	116	75	R-L/DX-SX	2,90	1
R14031	85	135	58	R-L/DX-SX	3,70	1
R14042	95	152	83	R-L/DX-SX	5,60	1
R14051	110	170	108	R-L/DX-SX	9,40	1

## Handle for Sphere 1-2 Grooves

Maniglia sfera

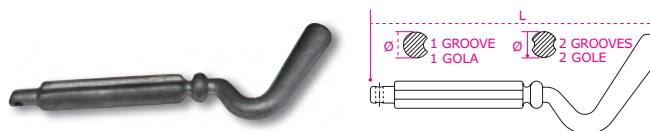

ARTICLE 1 GROOVE 1 GOLA	ARTICLE 2 GROOVES 2 GOLE	D sphere	L	D	KG	
R04730	R04731	60	194	18	0,31	1
R04734	R04735	75	220	18	0,36	1
R04697	R04699	85	251	24	0,70	1
R04680	R04682	95	265	24	0,80	1
R04762	R04763	110	293	30	1,10	1

## Washer for Sphere 1-2 Grooves

Rondella per sfera

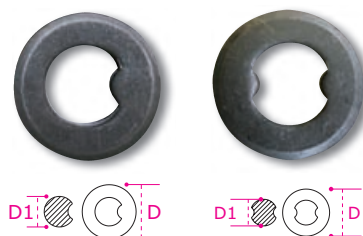

ARTICLE 1 GROOVE 1 GOLA	ARTICLE 2 GROOVES 2 GOLE	D sphere	D1	D	KG	
R04806	R04807	60-75	18	36	0,02	1
R04701	R04702	85-95	24	45	0,03	1
R04760	R04761	110	30	50	0,05	1

## Cotter Pin

Coppiglia a scatto

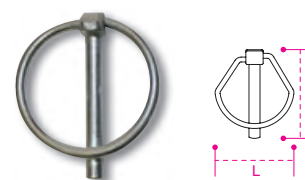

ARTICLE	D sphere	L	H	D	KG	
CS04	60-75 85-95	32	36	4,5	0,01	1
CS05	110	44	46	5	0,02	1

# Hinges and Latches



## Galvanized Lever Latch

*Chiusura a Laccio Zincata*

ARTICLE	L	H	KG		
R17105	140	50	0,36	1	
R17106	Strike Plate Riscontro	40	55	0,08	1

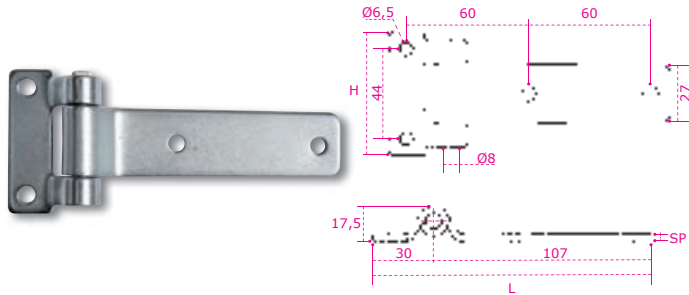

## Flat Hinge

*Cerniera Piana*

ARTICLE	L	H	SP	KG		
R17115	Stainless Steel Inox	137	60	3,5	0,195	1
R17115Z	Galvanized Zincata	137	60	3,5	0,195	1

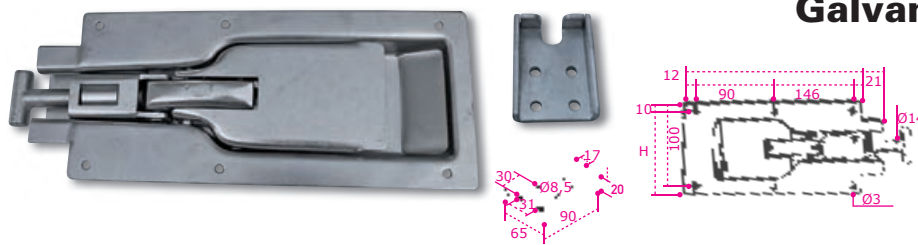

## Galvanized Recessed T Latch

*Chiusura Incassata a T Zincata*

ARTICLE	L	H	KG		
R17107	268	120	1,28	1	
R17108	Strike Plate Riscontro	90	65	0,08	1



## Complete Adjustable Latch to Welded

*Chiusura Registrabile a Saldare Completa*

ARTICLE	L	H	D	KG	
R17109	211	37	12	0,80	1

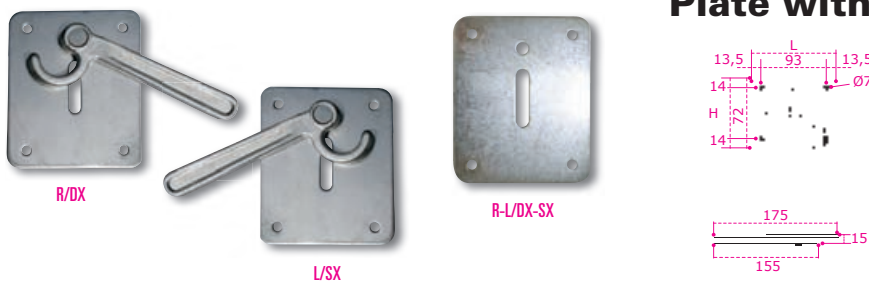

## Plate with External Hook for Chain

*Piastra con Aggancio Catena Esterno*

ARTICLE	L	H	DIR	KG	
R17104	120	100	DX	0,42	1
R17104S	120	100	SX	0,42	1
R30052	120	100	DX-SX	0,35	1



## Galvanized Chain Tensioner

*Tendicatena Completo Zincato*

ARTICLE	L	H	KG	
R17103	266	25	2,60	1



# Hinges and Latches

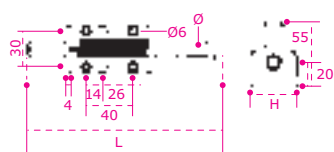

## Galvanized Spring Bolt

*Perno a Molla Zincato*

ARTICLE	L	H	D	KG	
R44899	160	34	12	0,35	1

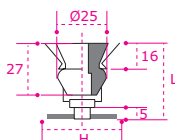

## Pvc Door Stop

*Fermaporta in Pvc*

ARTICLE	L	H	KG	
R17111	35	40	0,05	1



## Galvanized Interlocking Door Stop

*Fermaporta Zincato ad Incastro*

ARTICLE	L	H	KG	
R17112	65	42,5	0,24	1

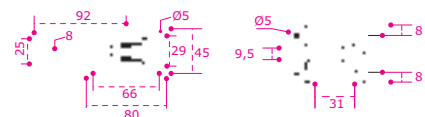
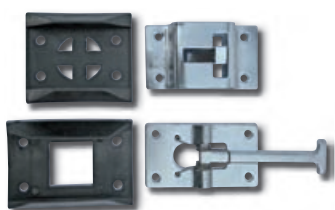

## Door Stop with Spring

*Fermaporta a Molla Completo*

ARTICLE	L	H	Ø	KG	
R18107 Galvanized Zincato	35	35	12,5	0,16	1
R18108 Stainless Steel Inox	35	35	12,5	0,16	1

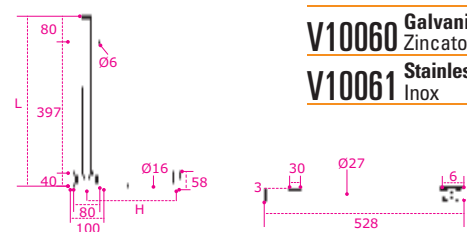

## Galvanized Rear Door Retainer

*Fermaporta Sottotelaio Zincato a Molla*

ARTICLE	L	H	Ø	KG	
V10060 Galvanized Zincato	528	270	16	2,00	1
V10061 Stainless Steel Inox	528	270	16	2,00	1

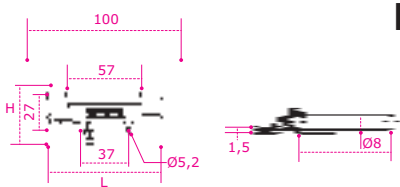

## Handle for Dropside With Spring

*Maniglia Sponda Zincata con Molla*

ARTICLE	L	H	KG	
R72110	86	45	0,12	1

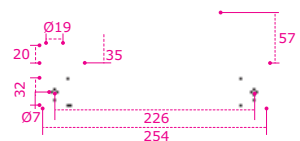

## Pvc Handle

*Maniglia di Salita in PVC*

ARTICLE	L	H	KG	
R17113	254	57	0,16	1

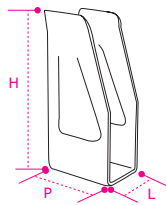

## Raw Bar Support for Curtainsider

Supporto Asta Centina Grezzo

ARTICLE	L	H	P	KG	
R52200	25	100	48	0,15	100
R52100	30	100	48	0,16	100

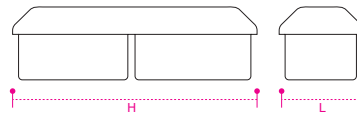

## Cap For Curtainsider Profile

Tappo Profilo Centina

ARTICLE	L	H	KG	
R190100	25	100	0,07	1

## Adhesive Felt

Feltro Adesivo



ARTICLE	MT	L	KG	
FS5050	10	0,5	0,09	1

## Levels for Stabilizers

Livella Stabilizzatori



ARTICLE	D	H	KG	
40F	55	0,5	0,07	1
63I	63	0,5	0,09	1
63F	80	0,5	0,09	1

## Levels for Stabilizers

Livella Stabilizzatori



ARTICLE	L	H	KG	
Q5	100	100	0,11	1

## Knob Latch

Chiusura a Pomolo Knob

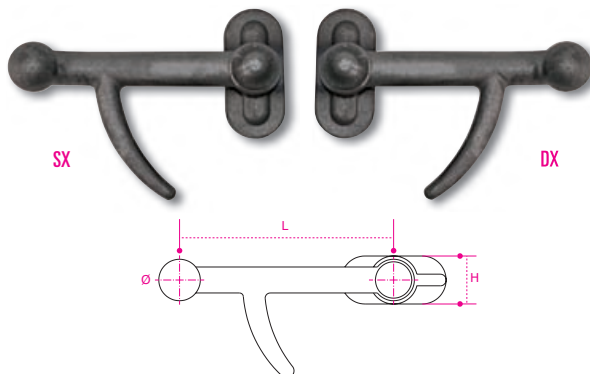

ARTICLE	DIR	L	H	D	KG	
R12024L	SX	82	21	9	0,15	1
R12024R	DX	82	21	9	0,15	1
R12040L	SX	107	25	12	0,24	1
R12040R	DX	107	25	12	0,24	1
R12041L	SX	130	30	14	0,43	1

ARTICLE	DIR	L	H	D	KG	
R12041R	DX	130	30	14	0,43	1
R12042L	SX	127	37	17	0,75	1
R12042R	DX	127	37	17	0,75	1
R12043L	SX	165	37	17	0,80	1
R12043R	DX	165	37	17	0,80	1

## Eye Bolt

Golfaro

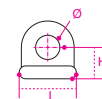

ARTICLE	L	H	D	KG	
R12028	27	15	9	0,03	1
R12044	32	17	12	0,04	1
R12045	34	19	14	0,05	1
R12046	40	22	17	0,09	1

# Rubber Buffers

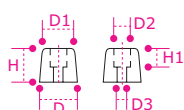

## Rubber Buffer for Dropside

*Battisponda*

ARTICLE	H	H1	D	D1	D2	D3	KG	
V30023	13	7	30	25	15,5	6,5	0,01	1

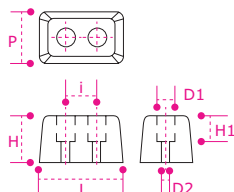

## Rubber Buffer 2 Holes

*Tampone Paracolpi 2 Fori*

ARTICLE	L	H	P	i	H1	D1	D2	KG	
V04015	50	30	30	24	10,5	12,5	7	0,05	1

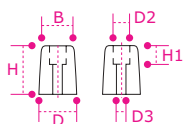

## Conical Rubber Buffer

*Tampone Paracolpi Conico*

ARTICLE	H	H1	D	D1	D2	D3	KG	
R02108	41	16	48	40	15	11	0,08	1
R02111	60	21	50	40	16	7	0,11	1
R02112	50	27	68	60	20	10	0,21	1
R01107	75	55	75	50	25	10	0,31	1
R02113	80	40	100	90	35	15	0,58	1

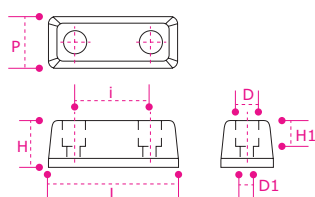

## Rubber Buffer 2 Holes

*Tampone Paracolpi 2 Fori*

ARTICLE	L	H	P	i	H1	D	D1	KG	
V30024	150	60	60	85	33	18	8	0,61	1
R01104	170	75	90	70	41	17,5	7	1,50	1
V30025	200	80	80	90	34	28	14	1,25	1
V30026	215	55	50	125	16	20	10	0,60	1
R01103	242	90	80	120	38	30	14	1,85	1
R02109	340	105	100	200	75	30	14	3,70	1

**i** Customizable in the central part.  
*Personalizzabile nella parte centrale.*

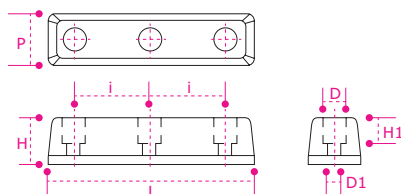

## Rubber Buffer 3 Holes

*Tampone Paracolpi 3 Fori*

ARTICLE	L	H	P	i	H1	D	D1	KG	
R01134	300	74	65	120	40	25	11	1,65	1
R01137	300	105	80	120	50	25	14	3,10	1
R01135	400	90	100	130	35	28	14	3,40	1
R01108	395	60	52	165	30	25	11	1,75	1

**i** Customizable on the right or on the left.  
*Personalizzabile sia nella parte destra che nella sinistra.*

# Rubber Buffers



## Rubber Buffer 4 Holes

*Tampone Paracolpi 4 Fori*

ARTICLE	L	H	P	i	H1	D	D1	KG	
V30027	400	70	65	105	40	25	13	2,25	1
V30028	450	60	40	120	20	20	9	1,45	1

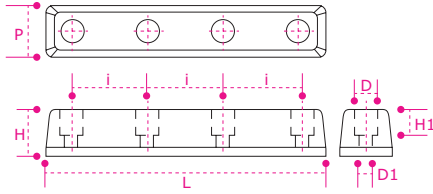

**i** Customizable in the three central points, at the customer's choice.  
*Personalizzabile nei tre punti centrali, a scelta del cliente.*



## Rubber Buffer

*Tampone Paracolpi*

ARTICLE	L	H	P	i	H1	D	D1	KG	
R02107 <sup>3 holes</sup> <sub>3 fori</sub>	460	40	47	205	14	13	7	0,90	1
R02110 <sup>4 holes</sup> <sub>4 fori</sub>	655	40	45	205	19	12	7	1,05	1

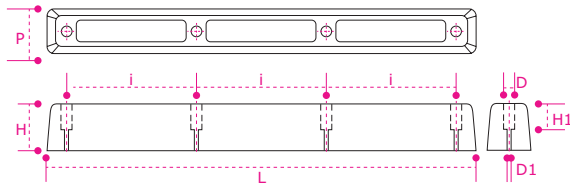

## Rubber Buffer with Aluminum Base

*Tampone Paracolpi con Base in Alluminio*

ARTICLE	L	H	P	i	L1	H1	SP	KG	
R01138	210	21	43	190	150	18	30/10	0,20	1

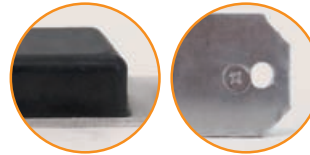
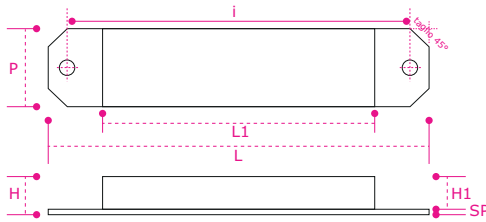

## Rubber Buffer 4 Holes *Tampone 4 Fori*

ARTICLE	L	H	P	i	H1	D1	D2	KG	
R01109	171	115	120	100	50	27	10	2,75	1

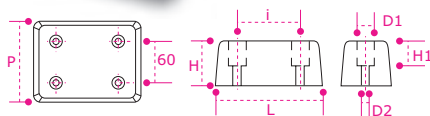

**i** Customizable in the central part.  
*Personalizzabile nella parte centrale.*

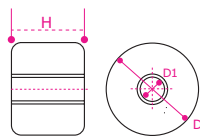

## Roller Rubber Buffer *Tampone a Rullo*

ARTICLE	H	D	D1	KG	
V30060	80	100	25,5	0,95	1

## Double Roller Rubber Buffer *Tampone a due Rulli*

ARTICLE	L	H	P	P1	KG	
V30062	210	120	115	90	5,25	1

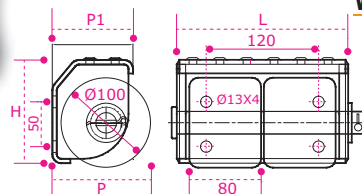

# Rubber Buffers

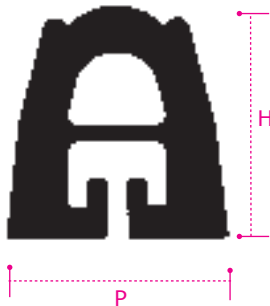
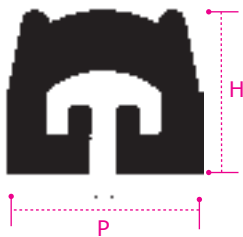
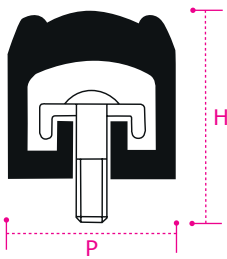
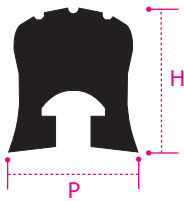
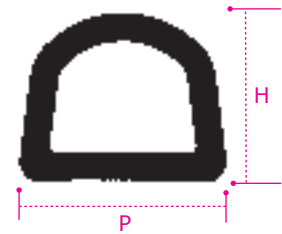
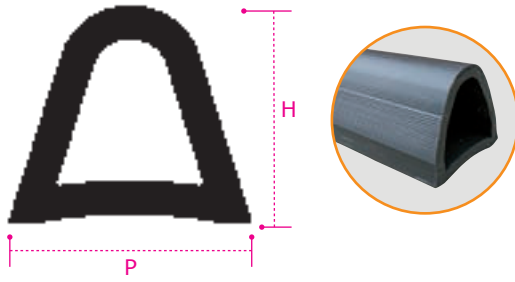

## Galvanized Steel Profile with Screws for Rubber Buffer

*Profilo Acciaio Zincato con Viti per Tampone*

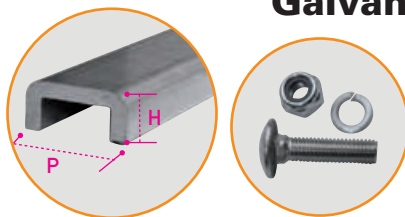

## Bumper Rubber Profile

*Profilo Paracolpi in Gomma*

ARTICLE	L	H	P	KG	
R05100	2600	95	110	6,95	1
R05101	2600	65	80	5,40	1

## Bumper Rubber Profile

*Profilo Paracolpi in Gomma*

ARTICLE	L	H	P	KG	
V30029	2600	70	85	8,50	1

## Bumper Rubber Profile

*Profilo Paracolpi in Gomma*

ARTICLE	L	H	P	KG	
V30030	2600	34	38	3,25	1

## Bumper Rubber Profile

*Profilo Paracolpi in Gomma*

ARTICLE	L	H	P	KG	
R051108	2600	40	40	8,50	1

## Medium Bumper Rubber Profile

*Profilo Paracolpi in Gomma Medio*

ARTICLE	L	H	P	KG	
R051110	2200	60	70	11,00	1

## Big Bumper Rubber Profile

*Profilo Paracolpi in Gomma Grande*

ARTICLE	L	H	P	KG	
R051111	2600	95	90	21,50	1

ARTICLE	L	H	P	KG	
R051113	2590	17	35	5,95	1

**i** For article R051108, R051110, R051111.  
Per gli articoli R051108, R051110, R051111.

# Wheel Carrier



## Hot Galvanized Wheel Carrier

Portaruota Zincato a caldo per 385/65 R22,5

ARTICLE	L	H	P	KG	
R02900	1235	500	620	30,3	1

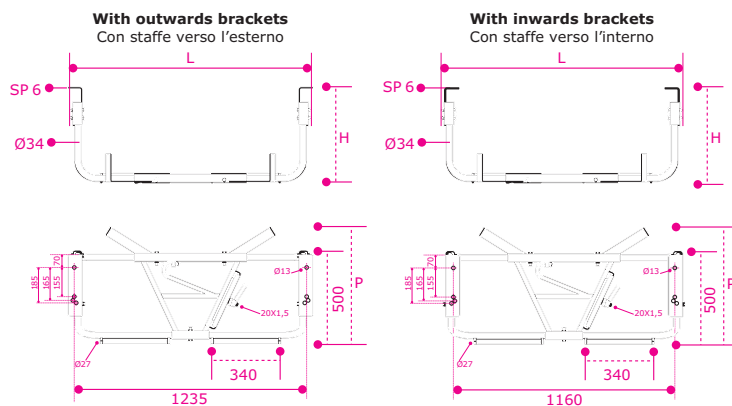
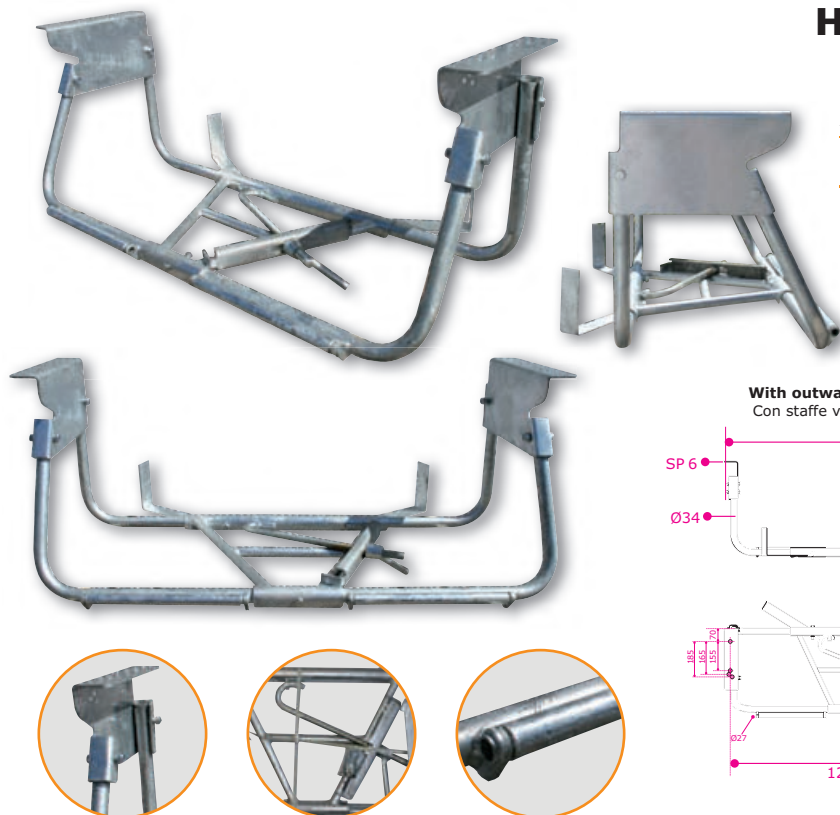

## Small Universal Wheel Carrier with Key

Portaruota Piccolo Universale con Chiave

ARTICLE	L	H	P	KG	
R21104	210	145	190	6,00	1

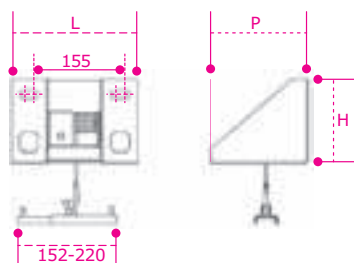

## Big Universal Wheel Carrier with Key

Portaruota Grande Universale con Chiave

ARTICLE	L	H	P	KG	
R20103	330	220	256	12,60	1

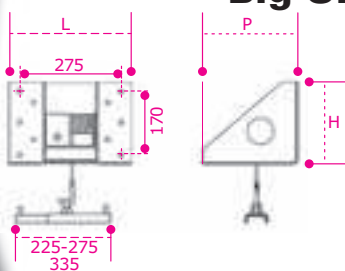
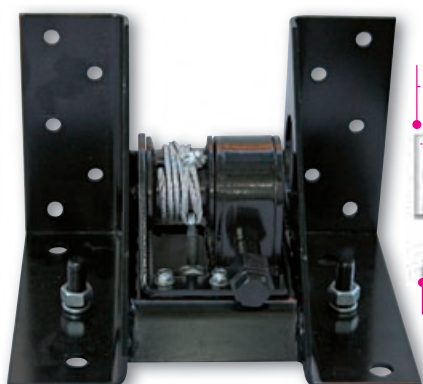

# Sideguards

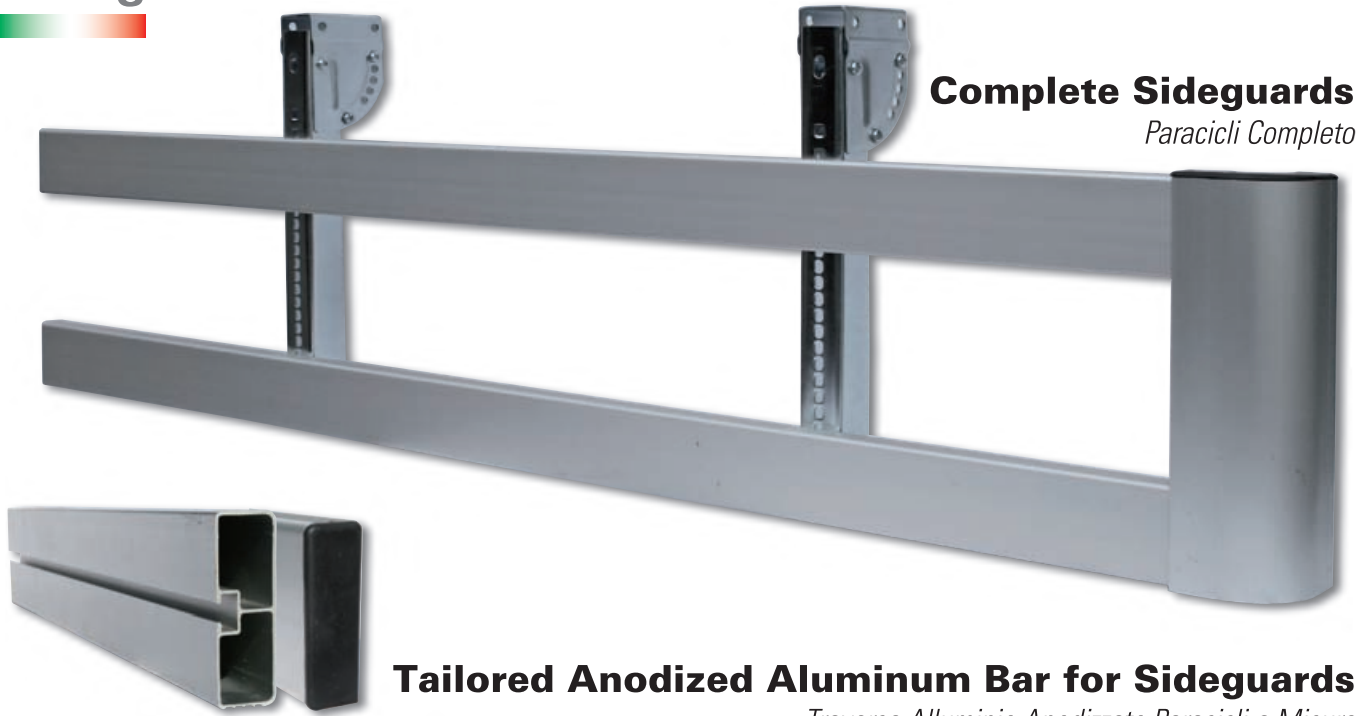

**Complete Sideguards**  
*Paracicli Completo*

**Tailored Anodized Aluminum Bar for Sideguards**  
*Traversa Alluminio Anodizzato Paracicli a Misura*

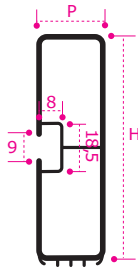

ARTICLE	L	H	P	Kg/ml
V30080	800	100	30	1,02
V30100	1000	100	30	1,28
V30120	1200	100	30	1,54
V30140	1400	100	30	1,79
V30160	1600	100	30	2,05
V30180	1800	100	30	2,31

ARTICLE	L	H	P	Kg/ml
V30200	2000	100	30	2,57
V30220	2200	100	30	2,82
V30240	2400	100	30	3,08
V30260	2600	100	30	3,34
V30280	2800	100	30	3,59
V30300	3000	100	30	3,85
V30320	3200	100	30	4,11



**PVC Corner Cap**  
*Tappo Pvc Angolare*

**Sideguard Profile Cap**  
*Tappo Profilo Paracicli*

**Complete Corner Profile with Caps**  
*Angolare Completo di Tappi*

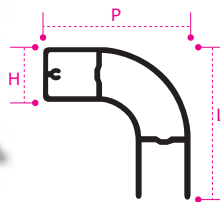
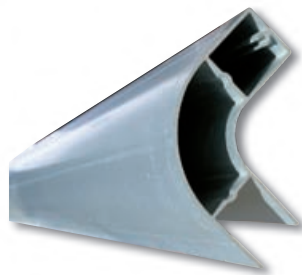

ARTICLE	L	H	P	Kg/ml
V30015	400	34,5	400	0,70
V30016	500	34,5	500	1,10
V30033	100	34,5	100	0,20

**Plates with Screws Kit**  
*Kit Piastrine con Viti*



ARTICLE	L	H	KG	
V30013	170	35	0,03	1

ARTICLE	L	H	KG	
V30012 <small>Pvc</small>	100	30	0,03	1
V30012G <small>Rubber Gomma</small>	100	30	0,07	1

ARTICLE	L	H	KG	
V130014	60	20	0,09	1

**i** N. 2 plates, n. 2 screws 8x1,25x16, n. 2 grower washer Ø8.  
N. 2 piastrine, n. 2 viti 8x1,25x16, n. 2 rondelle grower Ø8.

# Sideguards Supports



## Adjustable Sideguard Support

*Supporto Paracicli Registrabile*

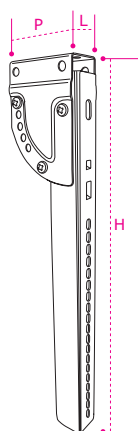

ARTICLE		L	H	P	KG	
V10100	Galvanized Zincata	50	575	110	2,10	2
V10101	Galvanized Zincata	55	735	135	2,60	2

ARTICLE		L	H	P	KG	
V10111	Stainless Steel Inox	50	575	110	2,10	2
V10112	Stainless Steel Inox	55	735	135	2,60	2

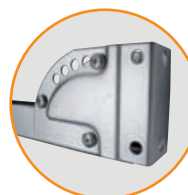

## Sideguard Support with Holes

*Supporto Paracicli Asolato*

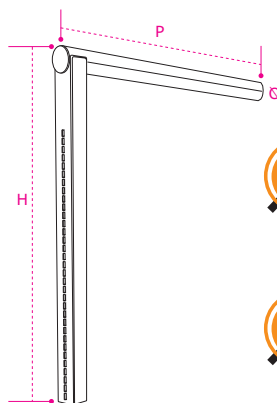

ARTICLE		D	H	P	KG	
V10107	Galvanized Zincato	42x2	470	600	3,60	100
V10113	Stainless Steel Inox	42x2	470	600	3,60	100



ARTICLE		D	H	P	KG	
V10106	Galvanized Zincato	54x2	735	800	4,30	100
V10114	Stainless Steel Inox	54x2	735	800	4,30	100



TKcert RINA UNI EN ISO 15614-1:2012

## Tubular Sideguard Support

*Supporto Paracicli Tubolare*

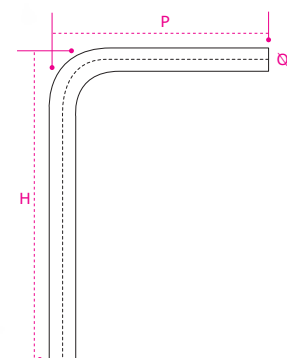
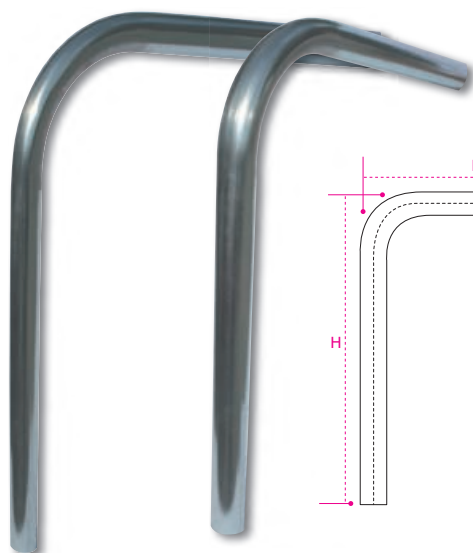

ARTICLE		D	H	P	KG	
V10108	Galvanized Zincato	42x2	750	750	3,10	100
V10109	Stainless Steel Inox	42x2	750	750	3,10	100



ARTICLE		D	H	P	KG	
V10103	Galvanized Zincato	54x2	820	820	3,90	100
V10104	Stainless Steel Inox	54x2	820	820	3,90	100



## Fixing Band

*Fascia Fissaggio*

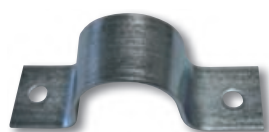

ARTICLE		L	D	KG	
V30017	Galvanized Zincato	120	54	0,14	1
IN30017	Stainless Steel Inox	120	54	0,14	1



# Aluminum Profiles



## Anodized Aluminum Profile

*Profilo Mono Sponda*

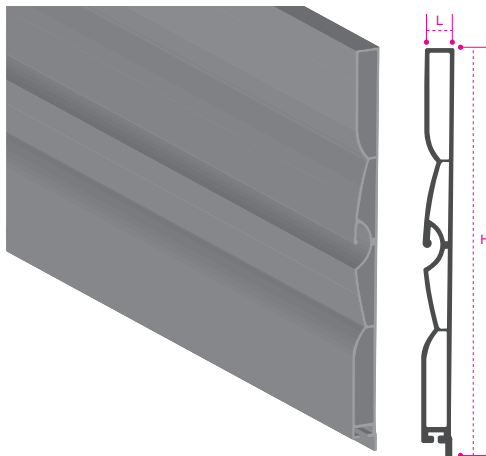

ARTICLE	L	H	Length	Kg/ml
V30019	25	400	6000	4,590

## Profile for Curtain Side

*Profilo per Centina*

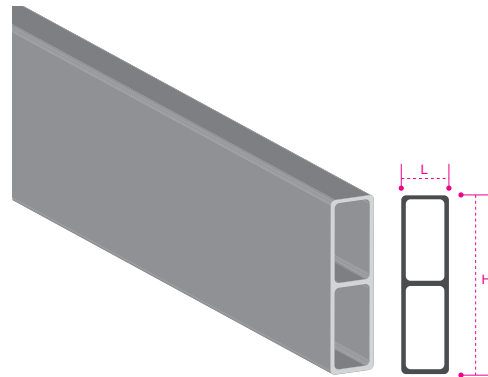

ARTICLE	L	H	Length	Kg/ml
V30020	25	100	6000	1,10

## Tarpaulin Hook Profile

*Profilo Aggancio Telo*

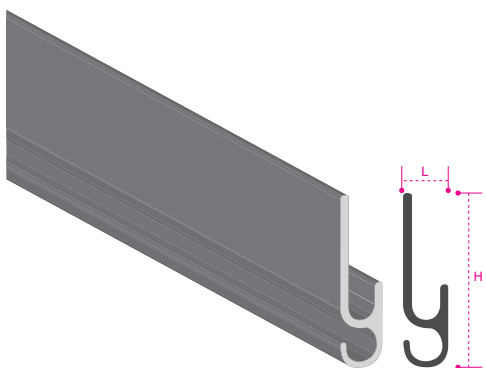

ARTICLE	L	H	Length	Kg/ml
V300151	18	70	5400	0,873

## Tensor Profile

*Profilo Tensionatore*

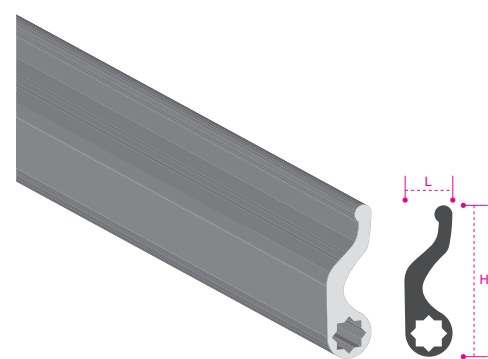

ARTICLE	L	H	Length	Kg/ml
V300161	28	87	5400	2,746

## Anodized Aluminum Lateral Profile with Slot

*Profilo Paracicli*

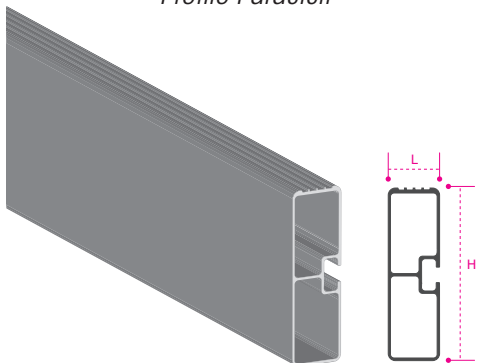

ARTICLE	L	H	Length	Kg/ml
V30010	30	100	6000	1,285

## Anodized Aluminum Corner Profile

*Profilo Angolare*

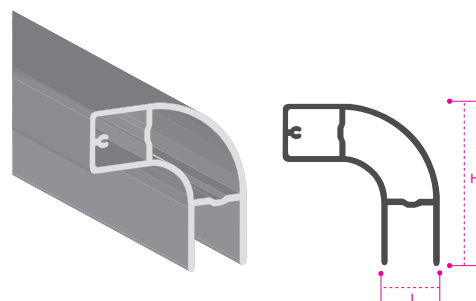

ARTICLE	L	H	Length	Kg/ml
V30011	34,5	100	5900	2,19

# Aluminum and Rubber Profiles



## Complete Profile

*Profilo Completo*

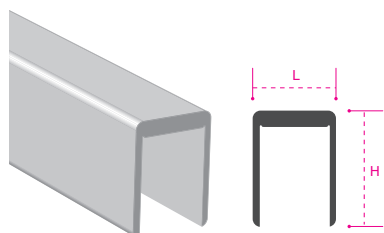

ARTICLE	L	H	Length	Kg/ml
V300171	25,5	40	6000	0,723

## Complete Profile

*Profilo Completo*

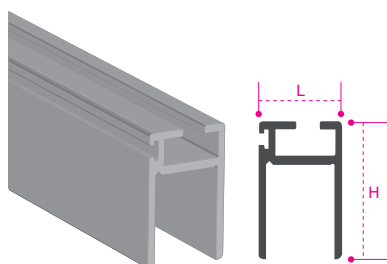

ARTICLE	L	H	Length	Kg/ml
V30018	25,5	50	6000	1,068

## Aluminum Profile

*Profilo con unghietta*

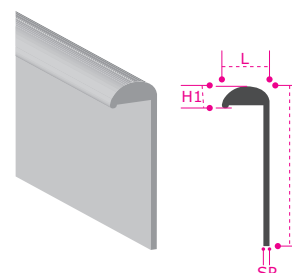

ARTICLE	L	H	H1	SP	Length	Kg/ml
VS3596	7	22	3	1	6000	0,085

## Aluminum Profile

*Profilo Semitondo Doppia Unghietta*

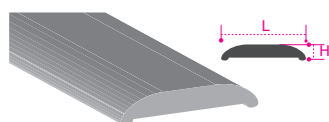

ARTICLE	L	H	Length	Kg/ml
VS3247	35	30	6000	0,232

## Aluminum Bushes

*Boccola Alluminio*

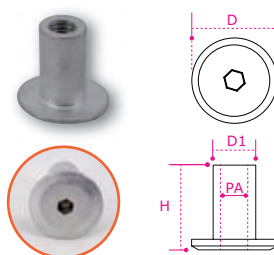

ARTICLE	H	D	D1	PA	KG
R88100	25	25	1,25	8	0,06
R90100	30	25	1,25	8	0,09

## PVC and Rubber Profile

*Profilo Pvc Gomma*

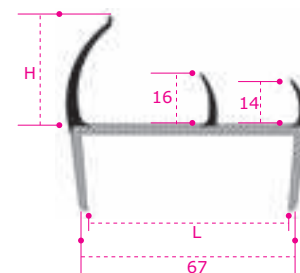

ARTICLE	L	H	Length	KG
V30046	63	34	2700	1,62

## PVC and Rubber Profile

*Profilo Pvc Gomma*

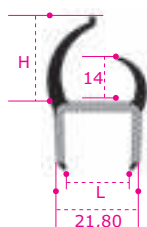

ARTICLE	L	H	Length	KG
V30040	19,8	27	2700	1,30

## PVC and Rubber Profile

*Profilo Pvc Gomma*

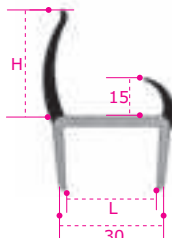

ARTICLE	L	H	Length	KG
V30042	28	33	2700	1,30

## PVC and Rubber Profile

*Profilo Pvc Gomma*

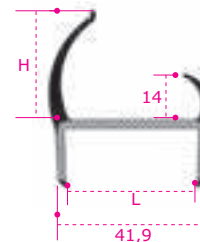

ARTICLE	L	H	Length	KG
V30044	39	34	2700	1,30

# Aluminum Dropside Lock



## Aluminum Dropside Lock Vertical Pivot

*Piantone Alluminio Perno Verticale*

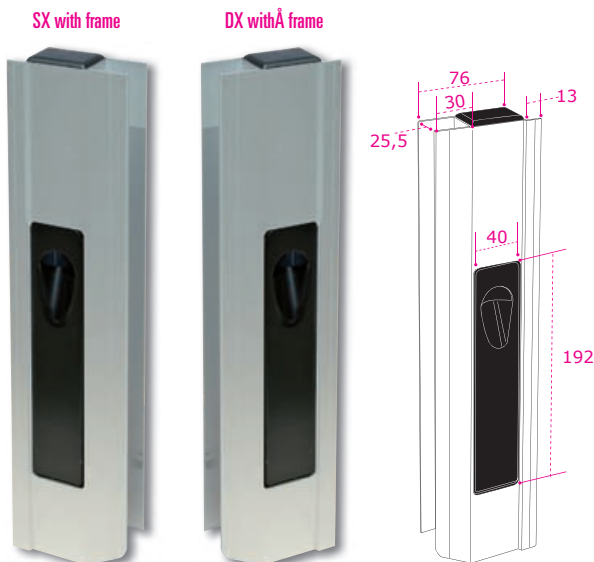

ART. With frame ART. Con battuta	ART. Without frame ART. Senza battuta	DIR	H	KG
01CB300D	01SB300D	DX	300	0,83
01CB300S	01SB300S	SX	300	0,83
01CB350D	01SB350D	DX	350	0,87
01CB350S	01SB350S	SX	350	0,87
01CB400D	01SB400D	DX	400	0,92
01CB400S	01SB400S	SX	400	0,92
01CB500D	01SB500D	DX	500	1,01
01CB500S	01SB500S	SX	500	1,01
01CB600D	01SB600D	DX	600	1,10
01CB600S	01SB600S	SX	600	1,10
01CB800D	01SB800D	DX	800	1,28
01CB800S	01SB800S	SX	800	1,28

**i** Aluminum dropside lock, vertical pivot with or without frame, black handle painted with cataphoresis, complete with polypropylene cap top.

*Piantone in alluminio perno verticale con e senza battuta, maniglia nera zincata verniciata in cataforesi, completo di tappo superiore in pp.*

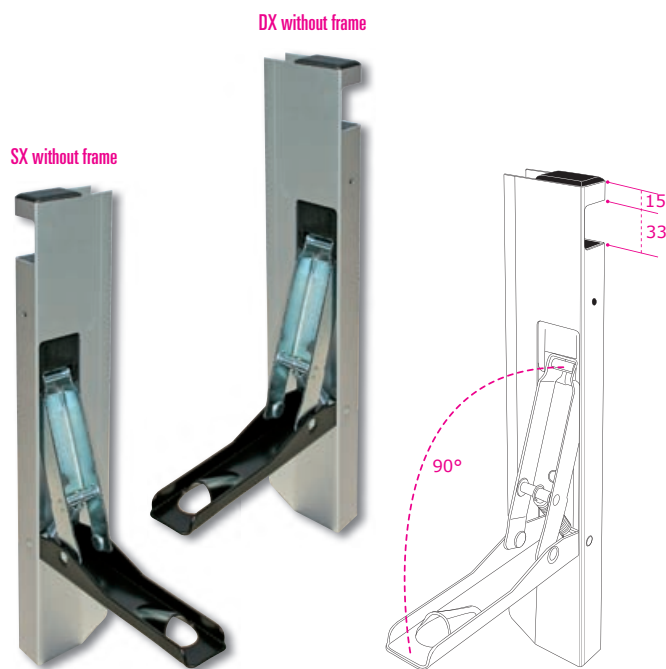

## Strike Plate to Weld

*Riscontro a Saldare*

ARTICLE	H	KG	
01U	30	0,03	1

## Example of Assembly

*Esempio di Assemblaggio Giospanda*

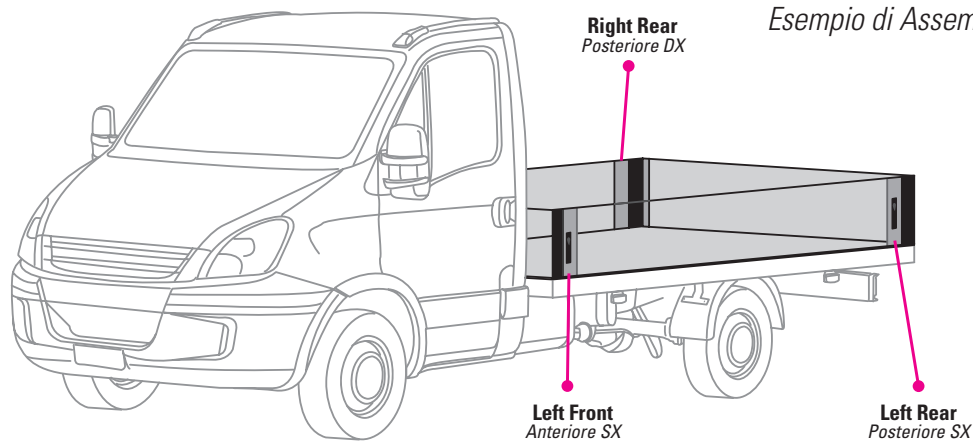

# Aluminum Dropside Lock

## Front Aluminum Dropside Lock Horizontal Pivot Metal Folding Handle

Piantone Alluminio Anteriore Perno Orizzontale Maniglia Rovesciabile in Metallo



ART. With frame ART. Con battuta	ART. Without frame ART. Senza battuta	DIR	H	KG
R87430	R87530	DX	300	0,83
R87431	R87531	SX	300	0,83
R87435	R87535	DX	350	0,87
R87436	R87536	SX	350	0,87
R87440	R87540	DX	400	0,92
R87441	R87541	SX	400	0,92
R87450	R87550	DX	500	1,01
R87451	R87551	SX	500	1,01
R87460	R87560	DX	600	1,10
R87461	R87561	SX	600	1,10
R87480	R87580	DX	800	1,28
R87481	R87581	SX	800	1,28

## Galvanized Strike Plate

Riscontro Zincato per Piantone Alluminio Perno Orizzontale



ARTICLE	H	KG	
R40000	72	0,03	1

## Rear Aluminum Dropside Lock Horizontal Pivot Metal Folding Handle

Piantone Alluminio Posteriore Perno Orizzontale Maniglia Rovesciabile in Metallo

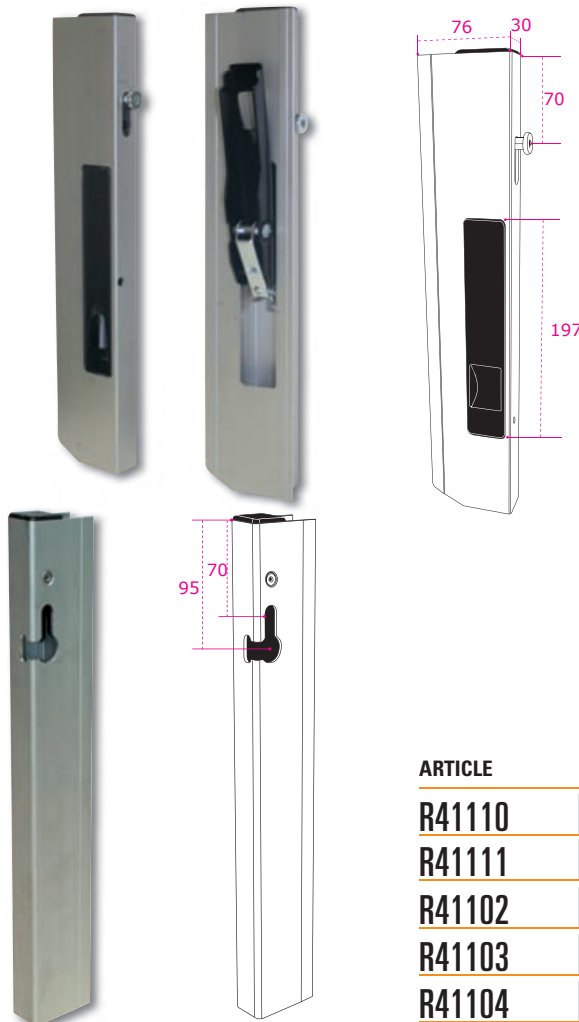

ART. With frame ART. Con battuta	ART. Without frame ART. Senza battuta	DIR	H	KG
R87230	R87330	DX	300	0,83
R87231	R87331	SX	300	0,83
R87235	R87335	DX	350	0,87
R87236	R87336	SX	350	0,87
R87240	R87340	DX	400	0,92
R87241	R87341	SX	400	0,92
R87250	R87350	DX	500	1,01
R87251	R87351	SX	500	1,01
R87260	R87360	DX	600	1,10
R87261	R87361	SX	600	1,10
R87280	R87380	DX	800	1,28
R87281	R87381	SX	800	1,28

## Terminal

Terminale per Piantone Alluminio Perno Orizzontale

ARTICLE	DIR	H	KG	ARTICLE	DIR	H	KG
R41110	DX	300	0,39	R41105	SX	500	0,49
R41111	SX	300	0,39	R41106	DX	600	0,54
R41102	DX	400	0,44	R41107	SX	600	0,54
R41103	SX	400	0,44	R41112	DX	800	0,60
R41104	DX	500	0,49	R41113	SX	800	0,60



Aluminum dropside lock, lateral pivot with or without frame, black metal handle, 180° tip up, complete with polypropylene cap top.  
Piantone in alluminio perno orizzontale con e senza battuta, anteriore sinistro corrisponde al posteriore destro, e viceversa.

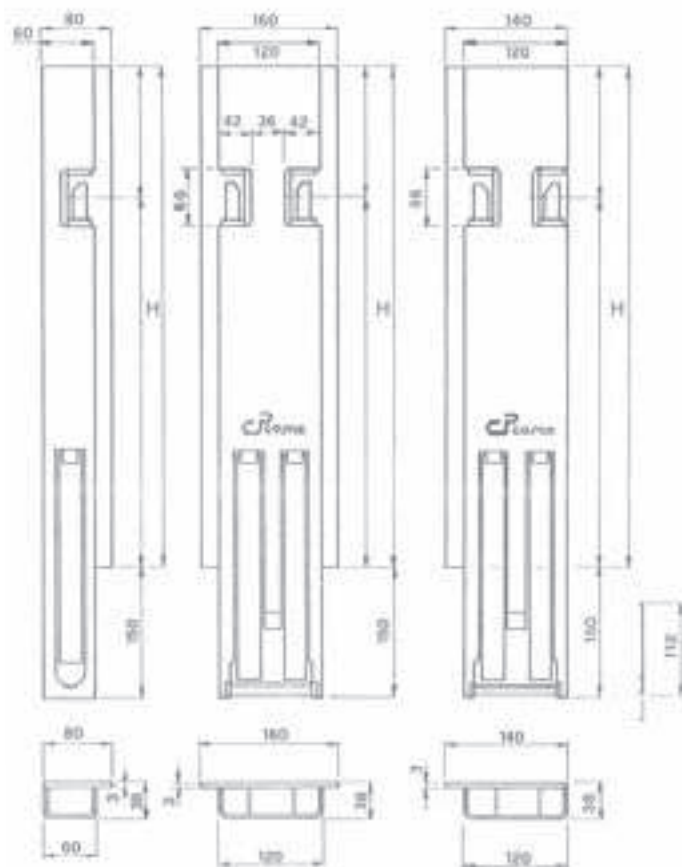

**i** Steel unhooking pillar painted by cathoresis with internal lever for the tipper. High mechanical quality and practicality in releasing the plate from the tipper, included with the article.  
 Montante in acciaio sganciabile verniciato in cataforesi con leve interne per sponda fissa. Elevata qualità meccanica e praticità nello sganciamento della piastra al cassone, compresa nell'articolo.

## Fix Board Pillars

Montanti Sponda Fissa Sganciabili

ARTICLE	DIR	DESCRIPTION	H	KG
100AD400	DX	Front/Anteriore	400	4,00
100AS400	SX	Front/Anteriore	400	4,00
100C400	CE	Central/Centrale	400	9,00
100PD400	DX	Rear/Posteriore	400	9,00
100PS400	SX	Rear/Posteriore	400	9,00
100AD500	DX	Front/Anteriore	500	4,50
100AS500	SX	Front/Anteriore	500	4,50
100C500	CE	Central/Centrale	500	10,00
100PD500	DX	Rear/Posteriore	500	10,00
100PS500	SX	Rear/Posteriore	500	10,00
100AD600	DX	Front/Anteriore	600	5,50
100AS600	SX	Front/Anteriore	600	5,50
100C600	CE	Central/Centrale	600	11,50
100PD600	DX	Rear/Posteriore	600	11,50
100PS600	SX	Rear/Posteriore	600	11,50
100AD800	DX	Rear/Posteriore	800	6,00
100AS800	SX	Central/Centrale	800	6,00
100C800	CE	Central/Centrale	800	13,50
100PD800	DX	Rear/Posteriore	800	13,50
100PS800	SX	Rear/Posteriore	800	13,50
100AD1000	DX	Front/Anteriore	1000	8,00
100AS1000	SX	Front/Anteriore	1000	8,00
100C1000	CE	Central/Centrale	1000	16,00
100PD1000	DX	Rear/Posteriore	1000	16,00
100PS1000	SX	Rear/Posteriore	1000	16,00

### EXAMPLE OF COMPLETE KIT FOR FIX BOARD H 600

Esempio Kit Completo Sponde Fisse H 600  
 4 Laterali - 1 Posteriore

100AD600	1	Front Pillar DX	Montante Anteriore DX
100AS600	1	Front Pillar SX	Montante Anteriore SX
100C600	2	Central Pillar	Montante Centrale
100PD600	1	Rear Pillar DX	Montante Posteriore DX
100PS600	1	Rear Pillar SX	Montante Posteriore SX
101AD600	4	Front Terminal DX	Testata Anteriore DX
101AS600	4	Front Terminal SX	Testata Anteriore SX
101PD600	1	Rear Terminal DX	Testata Posteriore DX
101PS600	1	Rear Terminal SX	Testata Posteriore SX
TAP01	2	Small Cap	Tappo Piccolo
TAP02	4	Big Cap	Tappo Grande



## Lateral Terminal

*Testata Laterale*

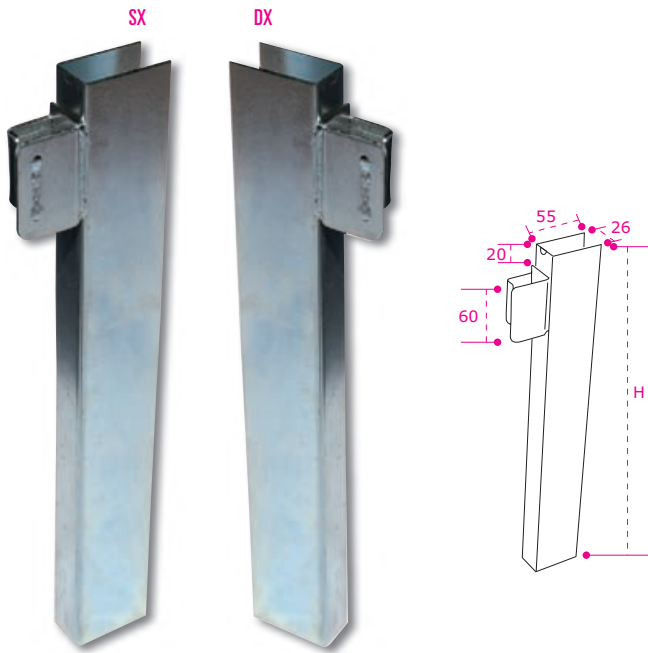

ARTICLE	DESCRIPTION	H	KG
101AD400	Font/DX - Rear/SX Ant. DX post. SX	400	0,80
101AS400	Front/SX - Rear/DX Ant. SX post. DX	400	0,80
101AD500	Font/DX - Rear/SX Ant. DX post. SX	500	1,00
101AS500	Front/SX - Rear/DX Ant. SX post. DX	500	1,00
101AD600	Font/DX - Rear/SX Ant. DX post. SX	600	1,00
101AS600	Front/SX - Rear/DX Ant. SX post. DX	600	1,00
101AD800	Font/DX - Rear/SX Ant. DX post. SX	800	1,50
101AS800	Front/SX - Rear/DX Ant. SX post. DX	800	1,50
101AD100	Font/DX - Rear/SX Ant. DX post. SX	1000	2,30
101AS100	Front/SX - Rear/DX Ant. SX post. DX	1000	2,30

## Rear Terminal

*Testata Posteriore*

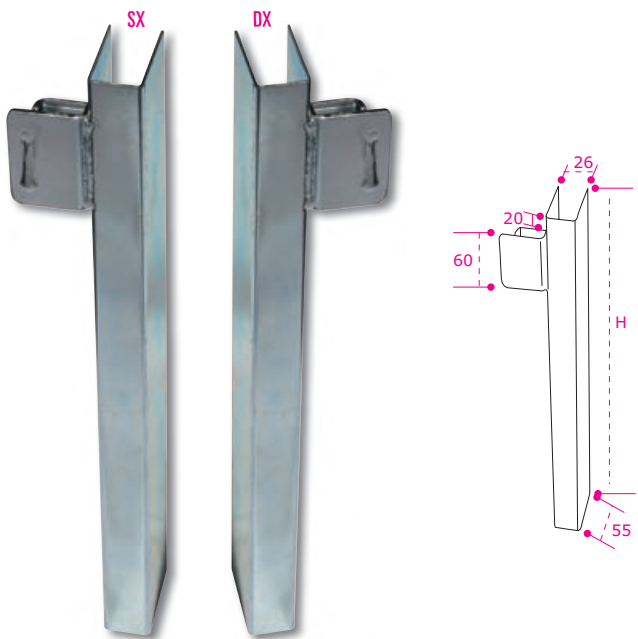

ARTICLE	DESCRIPTION	H	KG
101PD400	Rear/DX Posteriore DX	400	0,80
101PS400	Rear/SX Posteriore SX	400	0,80
101PD500	Rear/DX Posteriore DX	500	1,00
101PS500	Rear/SX Posteriore SX	500	1,00
101PD600	Rear/DX Posteriore DX	600	1,00
101PS600	Rear/SX Posteriore SX	600	1,00
101PD800	Rear/DX Posteriore DX	800	1,50
101PS800	Rear/SX Posteriore SX	800	1,50
101PD100	Rear/DX Posteriore DX	1000	2,30
101PS100	Rear/SX Posteriore SX	1000	2,30

## Galvanized Lateral Pocket

*Tasca Laterale*

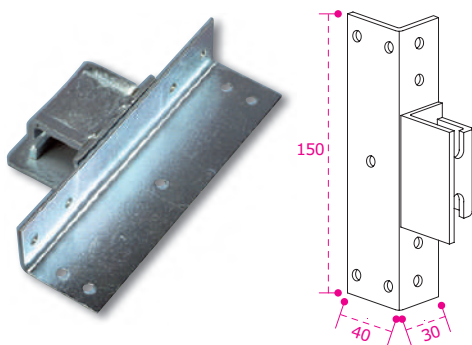

ARTICLE	DESCRIPTION	H	KG
101TLZ	Lateral Pocket Tasca riv. laterale zincata	150	0,30

## Galvanized Rear Pocket

*Tasca Posteriore*

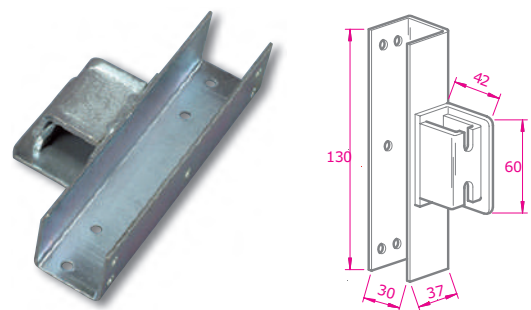

ARTICLE	DESCRIPTION	H	KG
101TPZ	Rear Pocket Tasca riv. post. zincata	130	0,35

## Adjustable Galvanized Lateral Pocket with Screws

Tasca Laterale con Viti

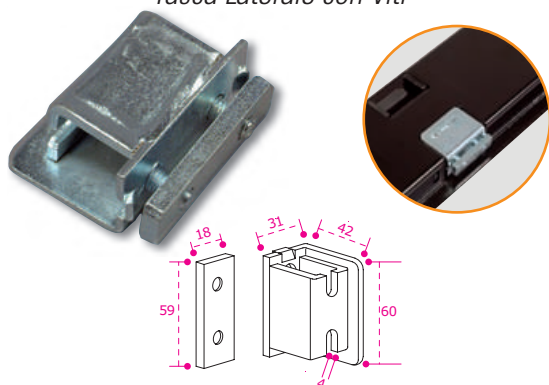

ARTICLE	DESCRIPTION	H	KG
101TL31	Lateral Pocket Tasca c/viti laterale zinc.	60	0,24

## Adjustable Galvanized Rear Pocket with Screws

Tasca Posteriore con Viti

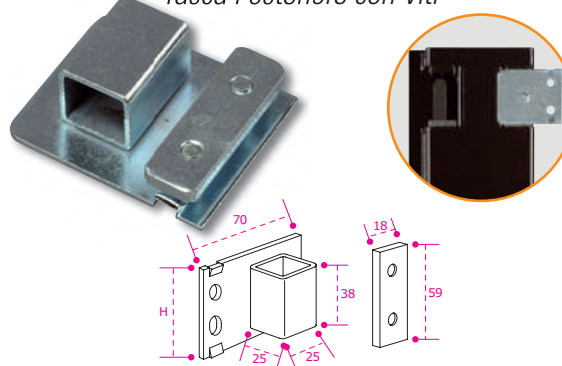

ARTICLE	DESCRIPTION	H	KG
101TP70	Rear Pocket Tasca c/viti post. zinc.	60	0,26

## PVC Caps for Pillars

Tappo PVC per Montanti



ARTICLE	DESCRIPTION	H	KG
TAP02	Cap for Big Pillar Tappo montante grande	120	0,06

## PVC Caps for Pillars

Tappo PVC per Montanti



ARTICLE	DESCRIPTION	H	KG
TAP01	Cap for Small Pillar Tappo montante piccolo	60	0,03

## Board Fixing Plate

Supporto Ricambio per Innesto Piantone

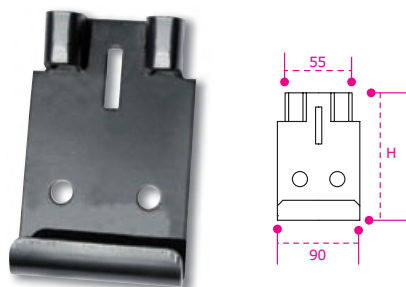

ARTICLE	H	KG
101SU	145	0,74

**i** Board fixing plate for line 100, 200 and 500.  
Supporto per innesto piantone per linea 100, 200 e 500.

## Female Coupling

Supporto per Innesto Piantone

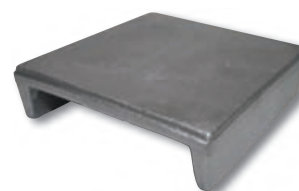

ARTICLE	L	H	P	KG
301SU	120	40	130	1,10

**i** Board fixing plate for line 300 and 800.  
Supporto per innesto piantone per linea 300 e 800.

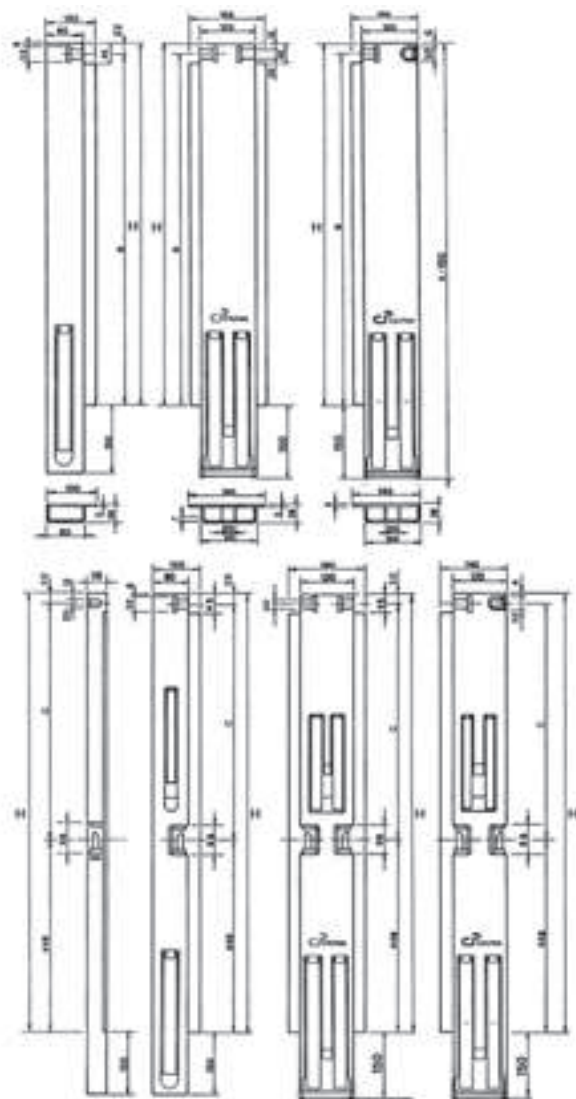

## Tipper Pillars

Montanti per Cassoni Ribaltabili

ARTICLE	DIR	DESCRIPTION	H	KG
200AD408	DX	Front/Anteriore	400	5,00
200AS408	SX	Front/Anteriore	400	5,00
200C400	CE	Central/Centrale	400	9,50
200PD400	DX	Rear/Posteriore	400	9,50
200PS400	SX	Rear/Posteriore	400	9,50
200AD508	DX	Front/Anteriore	500	5,50
200AS508	SX	Front/Anteriore	500	5,50
200C500	CE	Central/Centrale	500	11,00
200PD500	DX	Rear/Posteriore	500	11,00
200PS500	SX	Rear/Posteriore	500	11,00
200AD608	DX	Front/Anteriore	600	6,50
200AS608	SX	Front/Anteriore	600	6,50
200C600	CE	Central/Centrale	600	11,50
200PD600	DX	Rear/Posteriore	600	11,50
200PS600	SX	Rear/Posteriore	600	11,50
200AD808	DX	Front/Anteriore	800	7,80
200AS808	SX	Front/Anteriore	800	7,80
200C800	CE	Central/Centrale	800	14,50
200PD800	DX	Rear/Posteriore	800	14,50
200PS800	SX	Rear/Posteriore	800	14,50
200AD108	DX	Front/Anteriore	1000	10,50
200AS108	SX	Front/Anteriore	1000	10,50
200C100	CE	Central/Centrale	1000	18,00
200PD100	DX	Rear/Posteriore	1000	18,00
200PS100	SX	Rear/Posteriore	1000	18,00

**i** Steel unhooking pillar, painted by cathaphoresis with internal lever for the tipper. High mechanical quality and practicality in realising the plate from the tipper, included with the article.

Montante in acciaio sganciabile verniciato in cataforesi con leve interne per cassone ribaltabile. Elevata qualità meccanica e praticità nello sganciamento della piastra al cassone, compresa nell'articolo.



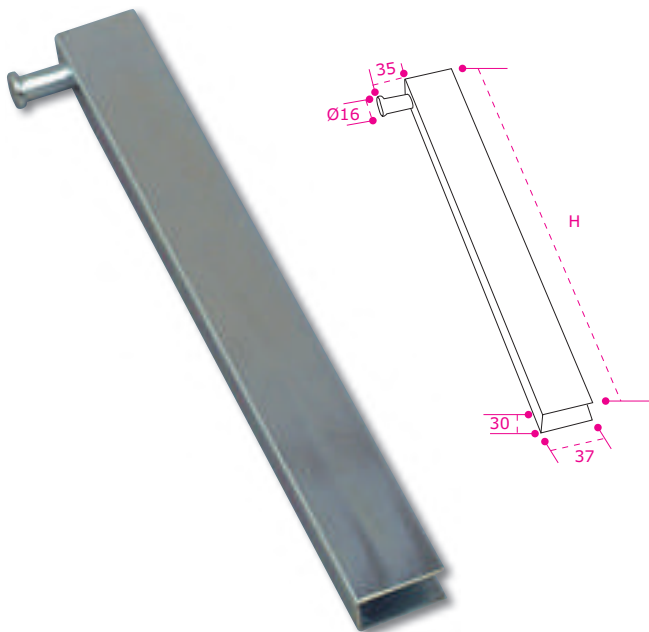

## Right/Left Terminal Rear Lateral

*Testata Dx/Sx Laterale Posteriore*

ARTICLE	DESCRIPTION	H	KG
201U400	Rear Lateral DX-SX Lat. post. DX-SX	400	0,70
201U500	Rear Lateral DX-SX Lat. post. DX-SX	500	0,80
201U600	Rear Lateral DX-SX Lat. post. DX-SX	600	1,00
201U800	Rear Lateral DX-SX Lat. post. DX-SX	800	1,30

## Dropsides Lock Terminal Line200

*Testata Piantoni Linea 200*

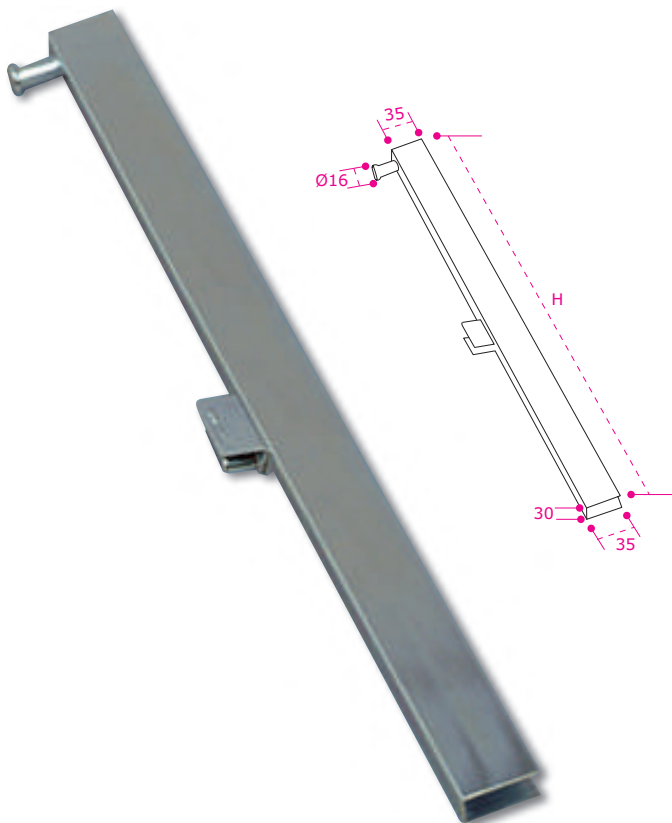

ARTICLE	DESCRIPTION	H	KG
201LSD100	Lateral DX Laterale DX	1000	1,80
201LSS100	Lateral SX Laterale SX	1000	1,80
201PSD100	Rear DX Posteriore DX	1000	1,80
201PSS100	Rear SX Posteriore SX	1000	1,80

## Dropsides Lock Terminal Line300

*Testata Piantoni Linea 300*

ARTICLE	DESCRIPTION	H	KG
301LSD100	Lateral DX Laterale DX	1000	1,80
301LSS100	Lateral SX Laterale SX	1000	1,80
301PSD100	Rear DX Posteriore DX	1000	1,80
301PSS100	Rear SX Posteriore SX	1000	1,80



## Wedge Pocket Pillar for Tippers

Montante Tasca Cuneo per Cassoni Ribaltabili

ARTICLE	DIR	DESCRIPTION	H	KG
300AD508	DX	Front/Anteriore	500	5,90
300AS508	SX	Front/Anteriore	500	5,90
300C500	CE	Central/Centrale	500	12,00
300PD500	DX	Rear/Posteriore	500	12,00
300PS500	SX	Rear/Posteriore	500	12,00
300AD608	DX	Front/Anteriore	600	6,90
300AS608	SX	Front/Anteriore	600	6,90
300C600	CE	Central/Centrale	600	13,00
300PD600	DX	Rear/Posteriore	600	13,00
300PS600	SX	Rear/Posteriore	600	13,00
300AD808	DX	Front/Anteriore	800	8,00
300AS808	SX	Front/Anteriore	800	8,00
300C800	CE	Central/Centrale	800	14,50
300PD800	DX	Rear/Posteriore	800	14,50
300PS800	SX	Rear/Posteriore	800	14,50
300AD108	DX	Front/Anteriore	1000	10,50
300AS108	SX	Front/Anteriore	1000	10,50
300C100	CE	Central/Centrale	1000	19,50
300PD100	DX	Rear/Posteriore	1000	19,50
300PS100	SX	Rear/Posteriore	1000	19,50

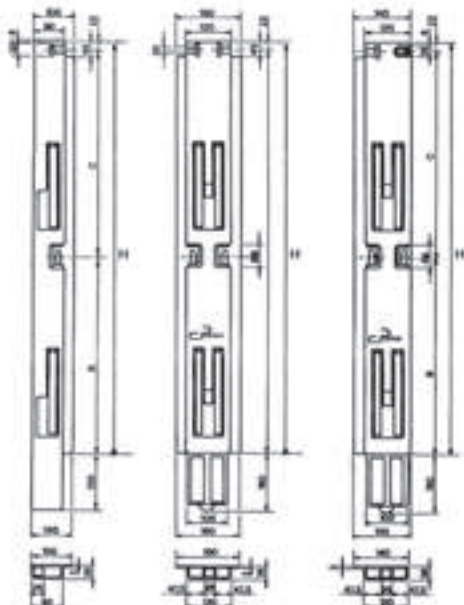
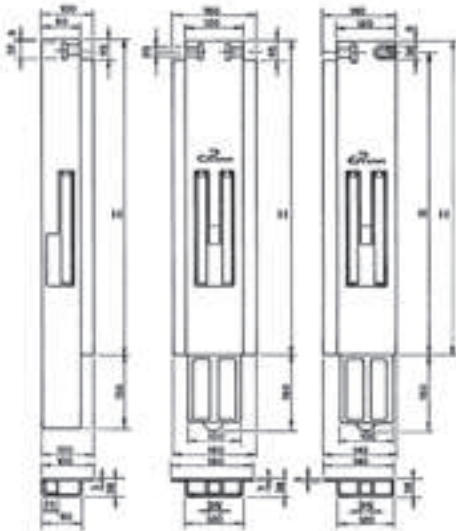

**i** Wedge pocket pillar for tippers, painted by cataphoresis with Aluminum dropside 25/30. Pocket include with the pillar.  
 Montante in acciaio, tasca cuneo, per cassone ribaltabile verniciato in cataforesi per sponda di alluminio 25/30mm. Tasca compresa nell'articolo.

## Female Coupling

Supporto per Innesto Piantone

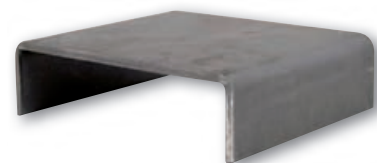

ARTICLE	L	H	P	SP	KG
201IN	123	100	35	4	0,55

**i** Female coupling For line 300 and 400.  
 Supporto per innesto piantone per linea 300 e 400.

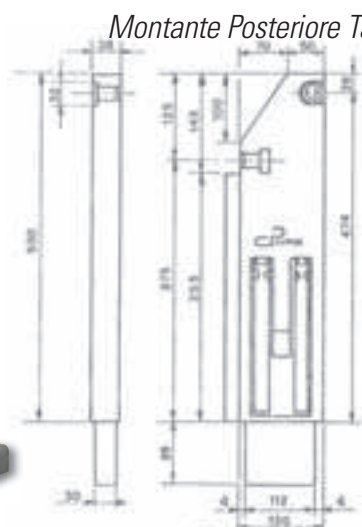

**Tipper Pillar "A Sbalzo"**  
*Montante Posteriore Tasca Cuneo 400/500 a Sbalzo L.120 Doppia Maniglia di Apertura*

ARTICLE	DIR	DESCRIPTION	H	KG
400PD4512	DX	Rear/Posteriore	400/500	8,50
400PS4512	SX	Rear/Posteriore	400/500	8,50

**i** Rear wedge pocket pillar 400/500 for tipper, painted with cataphoresis L120 with double lateral - rear opening.  
*Montante posteriore Tasca a Cuneo a sbalzo 400/500 per cassone ribaltabile verniciato in cataforesi L120 con doppia apertura laterale-posteriore.*

## Female Coupling *Supporto per Innesto Piantone*



ARTICLE	L	H	P	SP	KG
201IN	123	100	35	4	0,55

**i** Female coupling For line 300 and 400.  
*Supporto per innesto piantone per linea 300 e 400.*

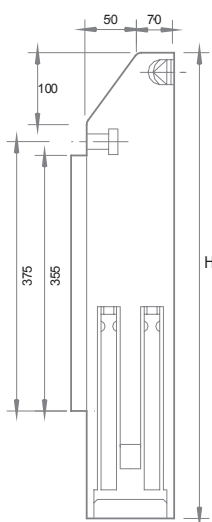

**Tipper Pillar "A Sbalzo"**  
*Montante Posteriore Rovesciabile 400-500 a Sbalzo L.120 Doppia Maniglia di Apertura*

ARTICLE	DIR	DESCRIPTION	H	KG
402PD4512	DX	Rear/Posteriore	400/500	8,50
402PS4512	SX	Rear/Posteriore	400/500	8,50

**i** Rear wedge pocket pillar 400/500 for tipper, painted with cataphoresis L120 with double lateral - rear opening.  
*Montante posteriore Tasca a Cuneo a sbalzo 400/500 per cassone ribaltabile verniciato in cataforesi L120 con doppia apertura laterale-posteriore.*

## Tipper Pillar "A Sbalzo"

*Montante Posteriore Tasca Cuneo 400-500 a Sbalzo L.80 Unica Maniglia di Apertura*

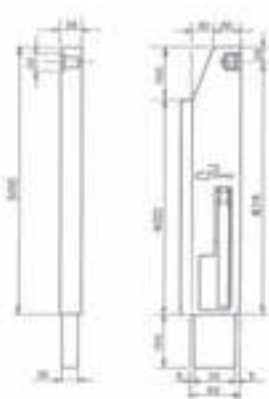

ARTICLE	DIR	DESCRIPTION	H	KG
400PD458	DX	Rear/Posteriore	400/500	5,50
400PS458	SX	Rear/Posteriore	400/500	5,50

## Terminal for Pillar "A Sbalzo"

*Testata per Montante a Sbalzo*

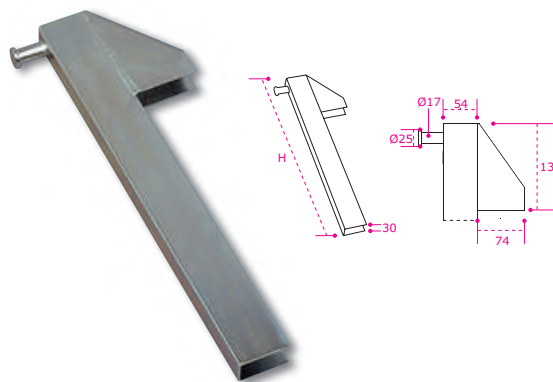

ARTICLE	DIR	DESCRIPTION	H	KG
401U	DX/SX	Front-Rear/Anteriore-Posteriore	400/500	1,20



## Top Pillar for Tippers

*Sopramontante Ribaltabile*

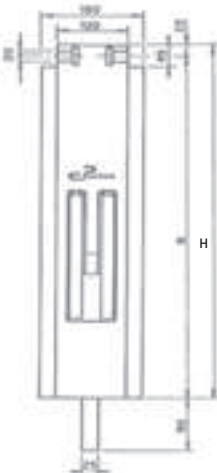
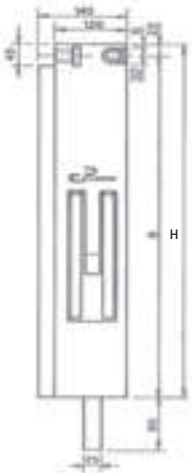
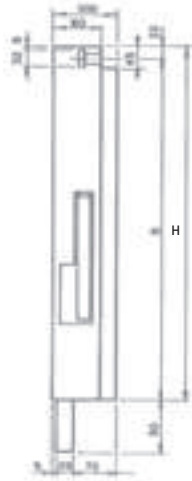

ARTICLE	DIR	DESCRIPTION	H	KG
600AD408	DX	Front/Anteriore	400	4,70
600AS408	SX	Front/Anteriore	400	4,70
600C400	CE	Central/Centrale	400	7,00
600PD400	DX	Rear/Posteriore	400	7,00
600PS400	SX	Rear/Posteriore	400	7,00
600AD508	DX	Front/Anteriore	500	5,50
600AS508	SX	Front/Anteriore	500	5,50
600C500	CE	Central/Centrale	500	8,00
600PD500	DX	Rear/Posteriore	500	8,00
600PS500	SX	Rear/Posteriore	500	8,00
600AD608	DX	Front/Anteriore	600	6,50
600AS608	SX	Front/Anteriore	600	6,50
600C600	CE	Central/Centrale	600	9,50
600PD600	DX	Rear/Posteriore	600	9,50
600PS600	SX	Rear/Posteriore	600	9,50
600AD708	DX	Front/Anteriore	700	7,50
600AS708	SX	Front/Anteriore	700	7,50
600C700	CE	Central/Centrale	700	10,50
600PD700	DX	Rear/Posteriore	700	10,50
600PS700	SX	Rear/Posteriore	700	10,50
600AD808	DX	Front/Anteriore	800	8,50
600AS808	SX	Front/Anteriore	800	8,50
600C800	CE	Central/Centrale	800	11,50
600PD800	DX	Rear/Posteriore	800	11,50
600PS800	SX	Rear/Posteriore	800	11,50

**i** Steel top pillar for a tipper, painted by cathaphoresis. It connects onto the back of the pillar Linea200 and Linea300 to increase the load volume.

*Sopramontante in acciaio ribaltabile per cassone, verniciato in cataforesi, si innesta sulla parte superiore del montante Linea200 e Linea300 per aumentare il volume di carico.*

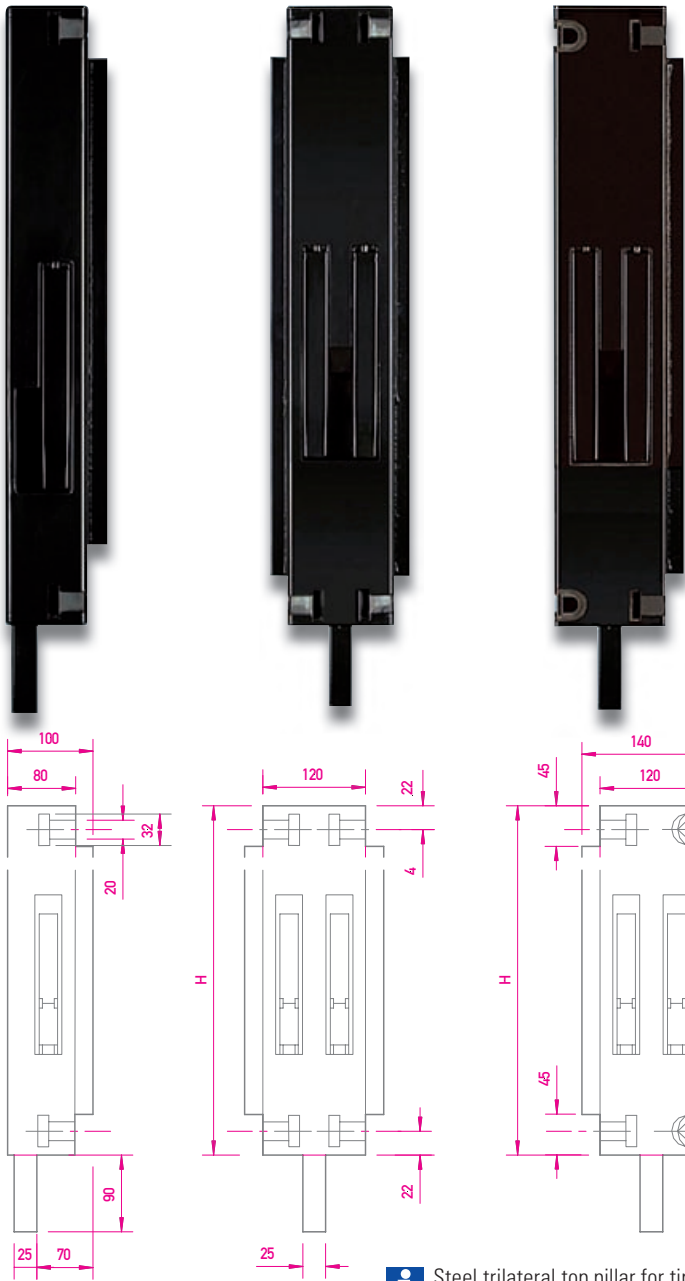

## Trilateral Top Pillar for Tipper

*Sopramontante Trilaterale*

ARTICLE	DIR	DESCRIPTION	H	KG
700AD408	DX	Front/Anteriore	400	4,80
700AS408	SX	Front/Anteriore	400	4,80
700C400	CE	Central/Centrale	400	6,80
700PD400	DX	Rear/Posteriore	400	6,80
700PS400	SX	Rear/Posteriore	400	6,80
700AD508	DX	Front/Anteriore	500	5,60
700AS508	SX	Front/Anteriore	500	5,60
700C500	CE	Central/Centrale	500	8,00
700PD500	DX	Rear/Posteriore	500	8,00
700PS500	SX	Rear/Posteriore	500	8,00
700AD608	DX	Front/Anteriore	600	6,80
700AS608	SX	Front/Anteriore	600	6,80
700C600	CE	Central/Centrale	600	9,50
700PD600	DX	Rear/Posteriore	600	9,50
700PS600	SX	Rear/Posteriore	600	9,50
700AD808	DX	Front/Anteriore	800	8,50
700AS808	SX	Front/Anteriore	800	8,50
700C800	CE	Central/Centrale	800	11,50
700PD800	DX	Rear/Posteriore	800	11,50
700PS800	SX	Rear/Posteriore	800	11,50

**i** Steel trilateral top pillar for tippers, painted by cathoresis. It connects onto the back of the pillar Line200 an Line300 to increase the load volume with the possibility of unhooking it on the upper and lower parts.  
*Sopramontante trilaterale in acciaio per cassoni ribaltabili, verniciato in cataforesi. Si innesta sulla parte posteriore del montante Linea200 e Linea300 per aumentare il volume di carico con la possibilità di sganciamento sulla parte superiore o inferiore.*

## Top Pillar Terminal

*Testata Sopramontante Fissa*



ARTICLE	DIR	DESCRIPTION	H	KG
702U400	DX-SX	Front-Rear/Anteriore-Posteriore	400	1,00
702U500	DX-SX	Front-Rear/Anteriore-Posteriore	500	1,20
702U600	DX-SX	Front-Rear/Anteriore-Posteriore	600	1,40
702U800	DX-SX	Front-Rear/Anteriore-Posteriore	800	1,60

## Trilateral Top Pillar Terminal

*Testata Sopramontante Trilaterale*



ARTICLE	DIR	DESCRIPTION	H	KG
701U400	DX-SX	Front-Rear/Anteriore-Posteriore	400	1,90
701U500	DX-SX	Front-Rear/Anteriore-Posteriore	500	2,30
701U600	DX-SX	Front-Rear/Anteriore-Posteriore	600	2,70
701U800	DX-SX	Front-Rear/Anteriore-Posteriore	800	3,10



## Wedge Pocket Pillar for Tipper TR5

Montante Sfilabile TR5

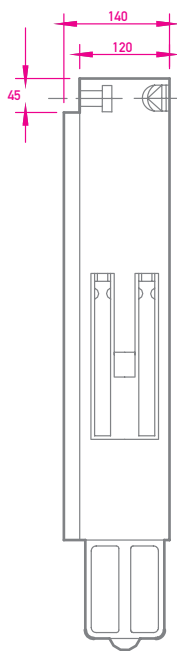
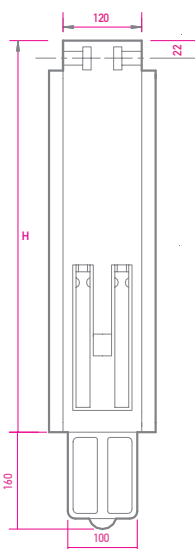
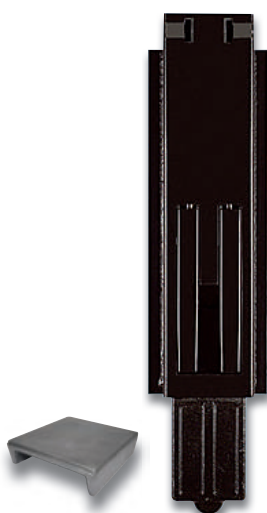
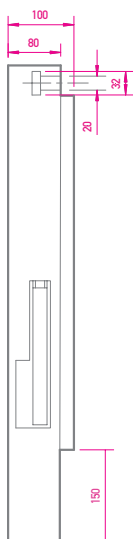

ARTICLE	DIR	DESCRIPTION	H	KG
800AD408	DX	Front/Anteriore	400	5,10
800AS408	SX	Front/Anteriore	400	5,10
800C400	CE	Central/Centrale	400	14,00
800PD400	DX	Rear/Posteriore	400	14,00
800PS400	SX	Rear/Posteriore	400	14,00
800AD508	DX	Front/Anteriore	500	5,80
800AS508	SX	Front/Anteriore	500	5,80
800C500	CE	Central/Centrale	500	12,50
800PD500	DX	Rear/Posteriore	500	12,50
800PS500	SX	Rear/Posteriore	500	12,50
800AD608	DX	Front/Anteriore	600	6,20
800AS608	SX	Front/Anteriore	600	6,20
800C600	CE	Central/Centrale	600	15,80
800PD600	DX	Rear/Posteriore	600	15,80
800PS600	SX	Rear/Posteriore	600	15,80
800AD808	DX	Front/Anteriore	800	7,80
800AS808	SX	Front/Anteriore	800	7,80
800C800	CE	Central/Centrale	800	17,50
800PD800	DX	Rear/Posteriore	800	17,50
800PS800	SX	Rear/Posteriore	800	17,50

**i** Wedge pocket pillar, painted by cathaphoresis, with internal lever for tipper with TR5 Aluminum 40mm. Plate included.  
 Montante in acciaio sfilabile verniciato in cataforesi con leve interne per cassoni ribaltabili con alluminio TR5 da 40 mm. Piastra compresa nell'articolo.

## Aluminum Terminal for Fix Board Pillar TR5

Testata per Sponde in Alluminio TR5

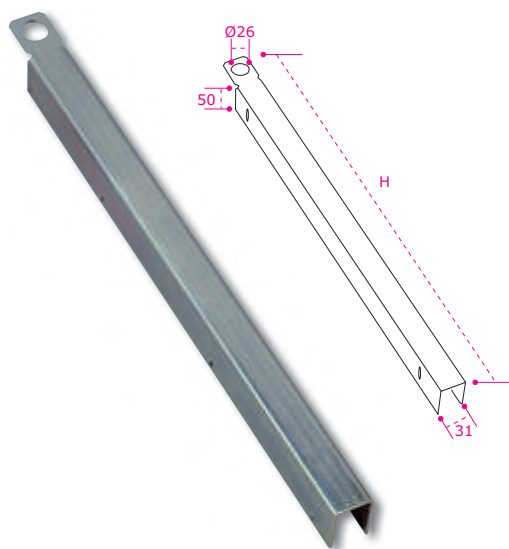

ARTICLE	DIR	DESCRIPTION	H	KG
801U400	DX-SX	Front-Rear/Anteriore-Posteriore	400	1,00
801U500	DX-SX	Front-Rear/Anteriore-Posteriore	500	1,25
801U600	DX-SX	Front-Rear/Anteriore-Posteriore	600	1,55
801U800	DX-SX	Front-Rear/Anteriore-Posteriore	800	2,10

## Galvanized Pivot TR5

Perno Zincato per TR5

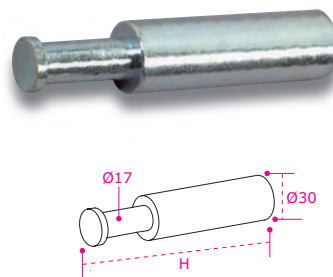

ARTICLE	DIR	DESCRIPTION	H	KG
801P	DX/SX	Pivot Perno zincato per TR5	116	0,80

## Female Coupling

Supporto per Innesco Piantone

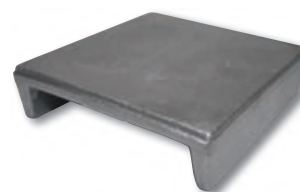

ARTICLE	DESCRIPTION	H	KG
301SU	For Line 300-800 Per Linea 300-800	130	1,10

## Joint Pillars for Curtain Body Central - Sliding

Montante a Snodo Centrale

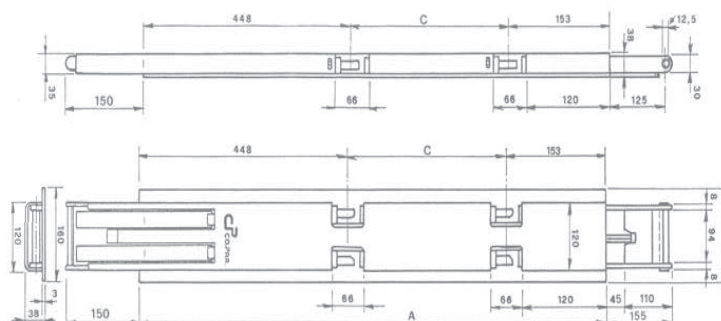
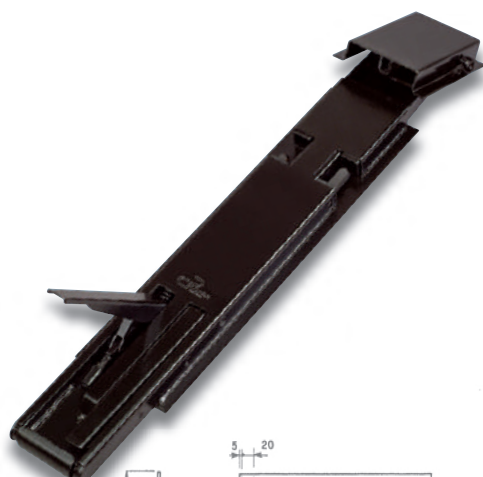

ARTICLE	DIR	DESCRIPTION	H	KG
500SC600	CE	Montante a snodo	14,80	600
500SC800	CE	Montante a snodo	17,10	800
500SC100	CE	Montante a snodo	19,20	1000

**i** Joint pillars for the central curtain body, painted by cathoresis, it can slide laterally and remain hanging if unhooked from the plate of the tipper.

Montante in acciaio a snodo per cassone centinato, verniciato in cataforesi, puo' scorrere lateralmente restando appeso se sganciato dalla piastra su cassone.

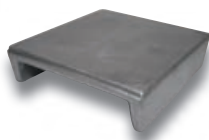
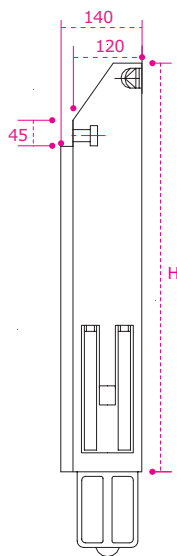

## Wedge Pocket Tipper Pillar TR5

Montante Sfilabile a Sbalzo TR5

ARTICLE	DIR	DESCRIPTION	H	KG
802PD4050	DX	Rear/Posteriore 400>500	400/500	8,50
802PS4050	SX	Rear/Posteriore 400>500	400/500	8,50
802PD5060	DX	Rear/Posteriore 400>500	500/600	9,50
802PS5060	SX	Rear/Posteriore 400>500	500/600	9,50
802PD6070	DX	Rear/Posteriore 400>500	600/700	10,80
802PS6070	SX	Rear/Posteriore 400>500	600/700	10,80
802PD8010	DX	Rear/Posteriore 400>500	800/900	12,00
802PS8010	SX	Rear/Posteriore 400>500	800/900	12,00

**i** Wedge pocket tipper pillar TR5, painted by cathoresis, internal levers for the tipper with Aluminum TR5 40mm. Plate included with the pillar.  
 Montante a sbalzo in acciaio sfilabile verniciato in cataforesi con leve interne per cassoni ribaltabili con alluminio TR5 da 40 mm. Piastra compresa nell'articolo.

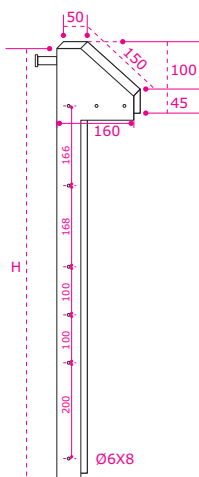

## Rear Terminal TR5

Testata posteriore Sbalzo TR5

ARTICLE	DIR	DESCRIPTION	H	KG
802U800DX	DX	Front-Rear/Anteriore-Posteriore	800	2,50
802U800SX	SX	Front-Rear/Anteriore-Posteriore	800	2,50

**i** Terminal for pillars "A Sbalzo" Aluminum TR5 dropside, cold galvanized, multi holes for attaching the rivets on the dropside.  
 Testata per montante a sbalzo sponda in alluminio TR5, zincata a freddo, multiforata per attacco con rivetti a sponda.



# Anti-Theft Fuel Caps



## Anti-Theft Fuel Cap Ø105

Antifurto Serbatoio Ø105



ARTICLE	H	D	KG	
R63105	185	80	0,62	1

## Anti-Theft Fuel Cap Ø80

Antifurto Serbatoio Ø80



ARTICLE	H	D	KG	
R63104	125	60	0,43	1

## Anti-Theft Fuel Cap Ø85

Antifurto Serbatoio Ø85



ARTICLE	H	D	KG	
R63109	170	60	0,80	1

## Anti-Theft Fuel Cap for Scania for Cap T37044

Antifurto Serbatoio Scania per Tappo Baionetta T37044



ARTICLE	H	D	KG	
R63105/1	166	60	0,64	1

## Anti-Theft Fuel Original Cap for Scania

Antifurto Serbatoio Scania per Tappo Originale



ARTICLE	H	D	KG	
R63108	166	60	0,64	1

## Fuel Cap Bayonet Connection with Key Ø80

Tappo Serbatoio Baionetta con Chiave Ø80



ARTICLE	H	D	KG	
T37044	35	80	0,39	1

## Fuel Cap Bayonet Connection with Key Ø60

Tappo Serbatoio Baionetta con Chiave Ø60



ARTICLE	H	D	KG	
T37006	32	60	0,30	1

## Fuel Cap with Key Ø60

Tappo Serbatoio Filettato con Chiave Ø60



ARTICLE	H	D	KG	
T37002	29	60	0,31	1

## Fuel Cap for Scania S4 with Key

Tappo Serbatoio Scania S4 con Chiave



ARTICLE	H	D	KG	
T37056	51	60	0,41	1

# Load Bars



## Universal Rail for Load Bar Mt 3

Rotaia Fermacarico Universale Mt 3



ARTICLE DESCRIPTION

80021 PVC Cap For Rail Tappo PVC rotaia fermacarico



ARTICLE	L	H	KG	
80018	3000	131	6,50	1
80020 Stainless Steel Inox	3000	131	6,50	1

## Rail for Load Bar - Round Connection Mt 3

Rotaia Fermacarico Attacco Tondo Mt 3



ARTICLE	L	H	KG	
80019	3000	86	3,10	1

## Aluminum Adjustable Load Bar

Barra Fermacarico Estensibile in Alluminio



ARTICLE	L	L1	H	KG	
1850	2400	2850	130	10,00	1



ARTICLE	L	H	SP	KG	
R30125 Clamp Pinza	350	160	30	2,64	1

ARTICLE	L	H	KG	
185002 Rubber Cup Gommino	45	105	0,05	1

cert DEKRA

## Galvanized Telescopic Adjustable Bar

Barra Telescopica Registrabile Zincata

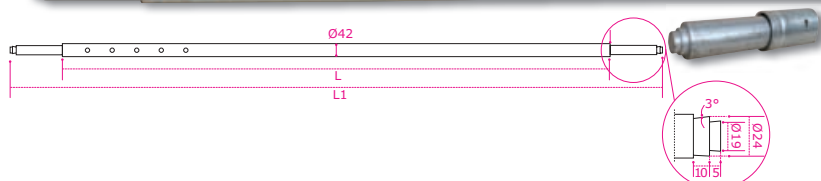

ARTICLE	L	L1	D	KG	
R70116	2200	2650	42	7,60	1

## Vertical Load Bar with White Rubber Buffer

Fermacarico Verticale con Tamponi Bianchi

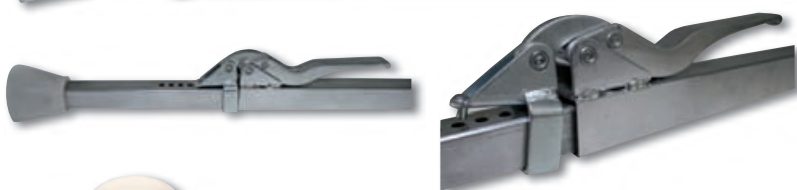

ARTICLE	L	L1	H	KG	
R70101	1850	2930	60	6,80	1

cert DEKRA

## Rubber Buffer for Vertical Load Bar

Tampone per Fermacarico Verticale



ARTICLE	D	H	KG	
R701011	80	75	0,23	10

# Load Bars



## Adjustable Vertical Load Bar

Barra Fermacarico Regolabile Verticale

ARTICLE		L	L1	D	KG	
1867WS	Aluminum Alluminio	2330	2730	42	4,00	1
1867Z	Galvanized Zincato	2330	2730	38	4,90	1



## Adjustable Horizontal Load Bar

Barra Fermacarico Regolabile Orizzontale

ARTICLE	L	L1	P	KG	
R70102	1940	3100	40	6,80	1

ARTICLE		L	H	SP	KG	
R30251	Rubber Cup Gommino	45	42	10	0,03	1

cert DEKRA

## Ratchet Strap Double Hooks

Cinghia Doppio Gancio



ARTICLE	L	H	KG	
80000	8,50+0,50	0,5	2,10	1

## Ratchet Strap Single Hook

Cinghia Gancio Singolo

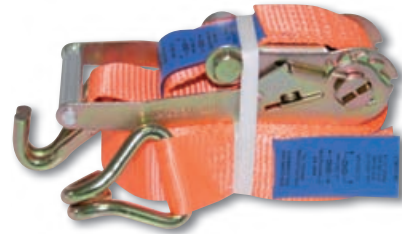

ARTICLE	L	H	KG	
80003	8,50+0,50	0,5	2,10	1

## Ratchet Strap Triangular Hook

Nastro Ancoraggio per Interni con Gancio Triangolare

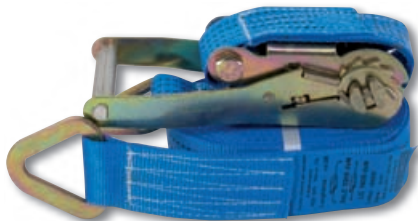

ARTICLE	L	H	KG	
80006	8,50+0,50	0,5	2,10	1

## Ratchet Strap

Nastro Ancoraggio per Interni

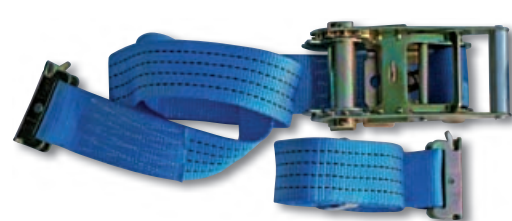

ARTICLE	L	H	KG	
80017	3,00+1,00	0,5	1,40	1

## Small Ratchet Strap

Nastro Ancoraggio Interni Piccolo



ARTICLE	L	H	KG	
LL60162	4,50+0,50	0,25	0,55	1

## Pvc Corner

Protezione Angolare



ARTICLE	L	L1	H	H1	KG	
80001086	180	135	150	70	0,25	1



## Retractable Lashing Ring

*Fermacarico a Scomparsa*



ARTICLE	L	H	D	KG	
R98400	65	105	10	0,62	1

The load is equal as required by the UNI EN 12640:2001. *Il carico applicato è come previsto da normativa UNI EN 12640:2001.*

## Black Painted Retractable Lashing Ring

*Fermacarico a Scomparsa Verniciato Nero*



ARTICLE	L	H	D	KG	
R98325	65	100	10	0,58	1

## Raw Retractable Lashing Ring

*Fermacarico a Scomparsa Grezzo*



ARTICLE	L	H	D	KG	
R98315	65	100	10	0,58	1

## Raw Recessed Lashing Ring

*Fermacarico Incassato Grezzo*



ARTICLE	L	H	D	KG	
R98110	90	97	90	0,90	1

## Galvanized Recessed Lashing Ring

*Fermacarico Incassato Zincato*



ARTICLE	L	H	D	KG	
R98210	90	97	90	0,90	1

## Galvanized Lashing Ring

*Cavallotto Fermacarico*



ARTICLE	L	H	PA	KG	
R55169	106	90,5	M12	0,20	100

The load is equal as required by the UNI EN 12640:2001. *Il carico applicato è come previsto da normativa UNI EN 12640:2001.*

## Galvanized Lashing Ring with Plate

*Cavallotto Fermacarico c/Piastra*



ARTICLE	L	H	PA	KG	
R55170	140	85	M12	0,46	100

The load is equal as required by the UNI EN 12640:2001. *Il carico applicato è come previsto da normativa UNI EN 12640:2001.*

## Galvanized Retractable Lashing Ring

*Fermacarico a Scomparsa Zincato*



ARTICLE	L	H	i	PA	KG	
R97110	100	80	65	M14	0,35	1

## Galvanized Retractable Lashing Ring

*Fermacarico a Scomparsa Zincato*

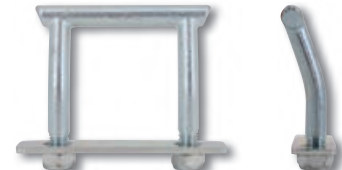

ARTICLE	L	H	i	PA	KG	
R97515	100	80	75	M12	0,35	1

## Galvanized Recessed Lashing Ring

*Anello Fermacarico Zincato*



ARTICLE	L	H	D	KG	
R55171	145	100	10	0,46	100

The load is equal as required by the DIN 75410-1:2003. *Il carico applicato è come previsto da normativa DIN 75410-1:2003.*

## Lashing Ring with Spring

*Anello Fermacarico con Molla*



ARTICLE	L	H	D	KG	
R55172	102	96	11	0,38	100

The load is equal as required by the DIN 75410-1:2003. *Il carico applicato è come previsto da normativa DIN 75410-1:2003.*

## Galvanized Lashing Ring

*Anello di Traino Zincato*



Certified  
12.000 Kg

ARTICLE	L	H	i	KG	
R96832	171	161	64x98	2,90	1

The load is equal as required by the EVS-EN 29367-2:2000. *Il carico applicato è come previsto da normativa EVS-EN 29367-2:2000.*

# Accessories for Tarpaulins



## Galvanized Lashing Ring

*Cavallotto Zincato H16*



ARTICLE	L	H	i	KG	
03030116	66	22	52	0,02	100

## Galvanized Lashing Ring

*Cavallotto Zincato H20*



ARTICLE	L	H	i	KG	
03030120	66	26	52	0,02	100

## Galvanized Oval Eyelet Tir

*Occhiello Tir Ovale Zincato*



ARTICLE	L	H	KG	
012042FZ	62	42	0,01	100

## Galvanized Hook for Dropside

*Gancio Sponda Zincato*



ARTICLE	L	H	i	KG	
R12102	60	30	40	0,03	100

## Galvanized Lashing Ring P7

*Punto P7 Zincato*



ARTICLE	L	H	KG	
050701FZ	21,5	10,2	0,01	100

## Spiral Hook

*Gancio Molla*



ARTICLE	L	H	KG	
07090801	60	8	0,03	100

## Small PVC Hook

*Gancio Cobra Piccolo*



ARTICLE	L	H	i	KG	
070702MB	45	20	25	0,04	100

## Open Hook "S"

*Gancio a "S" Aperto*



ARTICLE	L	D	KG	
070103FZ	50	5	0,01	100

## PVC Hook

*Gancio Pvc*



ARTICLE	L	H	KG	
07096506	65	35	0,02	100

## PVC Hook - Closed

*Gancio Zig Zag Chiuso*



ARTICLE	L	H	i	KG	
070501TC	63	24	20	0,02	100

## Big PVC Hook

*Gancio Cobra Grande*



ARTICLE	L	H	i	KG	
070702MG	55	23	30	0,06	100

## Pvc Hook for Dropside

*Gancio Sponda a "S" in Pvc*



ARTICLE	L	H	KG	
070301NY	36	37	0,05	100

## PVC Hook - Open

*Gancio Zig Zag Aperto*



ARTICLE	L	H	i	KG	
070501AA	61	22	20	0,02	100

## PVC Hook with Plate

*Piastrina Gancio Zig Zag Pvc*



ARTICLE	L	H	i	KG	
070599RI	36	16	20	0,02	100
070599NY	36	16	20	0,01	100
09013610	-	10	-	0,01	100

## Galvanized Wrapper

*Fascetta Fermacorda*



ARTICLE	L	H	KG	
05080101	25	10	0,02	100
05080102	12	10	0,02	100

# Accessories for Tarpaulins



## Elastic Rope for Tarpaulin *Fune Elastica Per Teloni*

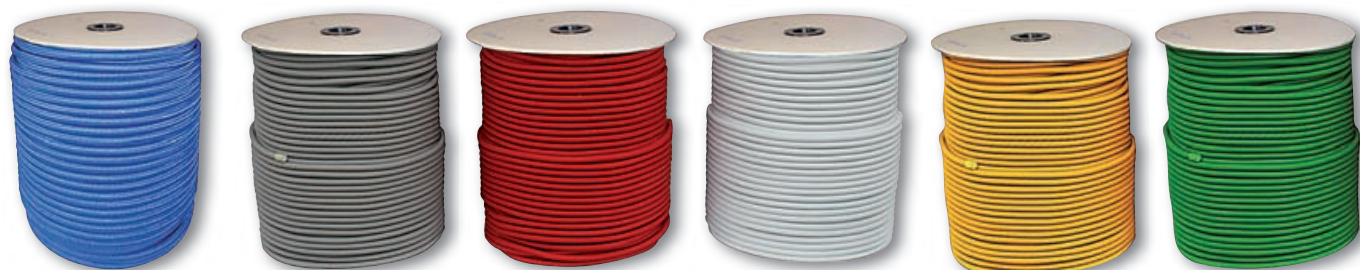

ARTICLE	L	D	KG	
112008B	200	8	8,90	1
112008G	200	8	8,90	1

ARTICLE	L	D	KG	
112008R	200	8	8,90	1
112008BI	200	8	8,90	1

ARTICLE	L	D	KG	
112008GI	200	8	8,90	1
112008V	200	8	8,90	1

## Wire Rope Clamp

*Cavallotto Fermacavo*



ARTICLE	D	L	KG	
V30021	8	35	0,03	100

## Tarpaulin Hook Profile

*Profilo Aggancio Telo*

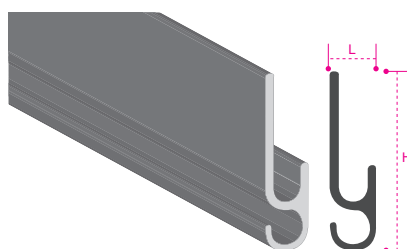

ARTICLE	L	H	Length	KG/ml
V300151	18	70	5400	0,873

## Tensor Profile

*Profilo Tensionatore*

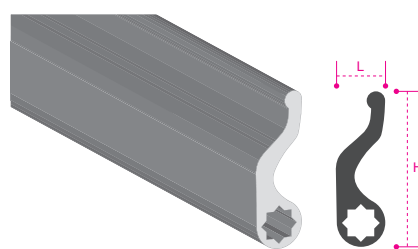

ARTICLE	L	H	Length	KG/ml
V300161	28	87	5400	2,746



## Tarpaulin Tensor

*Riduttore Tenditelo*

ARTICLE	L	H	P	KG	
V30022	730	400	400	0,70	1

## PVC and Steel Rope

*Cavo Pvc Anima Acciaio*



ARTICLE	L	D	KG	
11010601	100	6	3.10	1
11010801	100	8	3.90	1

## Antiturn Steel Wire Rope

*Cavo Acciaio Antigiro*



ARTICLE	L	D	KG	
11010602	105	6	17,00	1
11010802	105	8	27,00	1

# Spoiler



## Spoiler Daily >2000 - 2014 Master - Mascott - Movano <2009

ARTICLE	L	L1	H	P	KG	
S935V	1600	1800	700	730	13,00	3

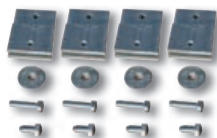

**Hardware Kit Included**  
Kit Ferramenta compreso

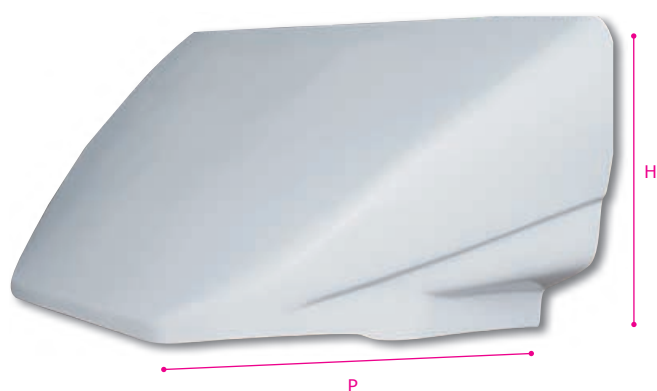

## Spoiler Nuovo Daily >07/2014 Bonding Fixing

*ad Incollaggio*

ARTICLE	L	L1	H	P	KG	
SDI2014	1570	2000	705	830	14,50	3



**Bonding Kit Included**  
Kit Incollaggio compreso

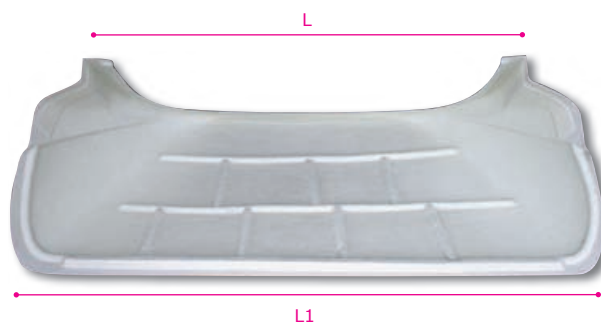

**i** Bonding spoiler, particularly recommended also for the fridge cut, reinforced grid on the central part and on all the external sides.

*Spoiler ad incollaggio, particolarmente consigliato anche per la scantonatura frigo, essendo rinforzato a griglia su tutta la parte centrale e su tutti i fianchi esterni.*

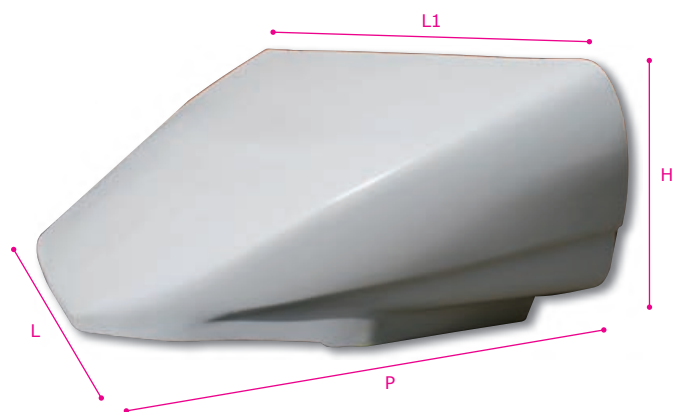

## Spoiler Fiat Ducato >2006 Citroën Jumper Peugeot Boxer >2006

ARTICLE	L	L1	H	P	KG	
S10011	1440	1900	700	700	11,50	3



**Bonding Kit Included**  
Kit Incollaggio compreso

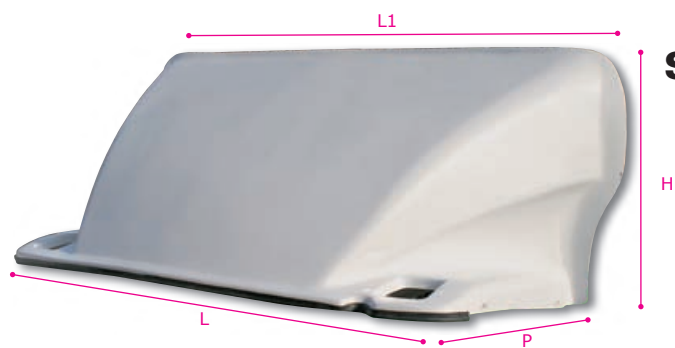

## Spoiler Ford Transit >2009 - 05/2014

ARTICLE	L	L1	H	P	KG	
S10012	1770	1800	750	730	11,00	3



**Hardware Kit Included**  
Kit Ferramenta compreso

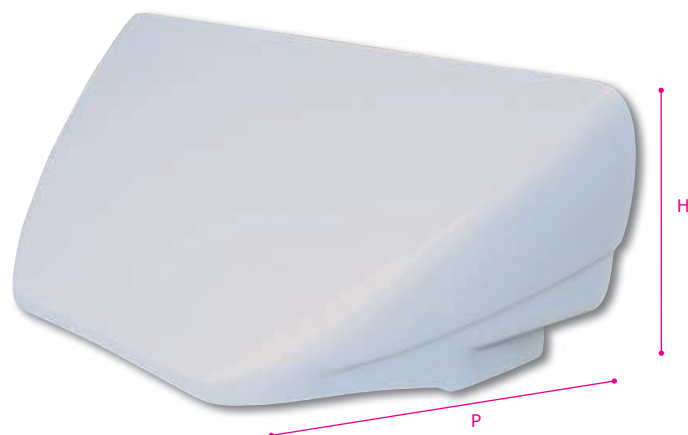

## Spoiler Nuovo Ford >06/2014 Bonding Fixing

*ad Incollaggio*

ARTICLE	L	L1	H	P	KG	
S10014	1630	1980	720	800	14,50	3



**Bonding Kit Included**  
Kit Incollaggio compreso



**i** Bonding spoiler, particularly recommended also for the fridge cut, reinforced grid on the central part and on all the external sides. *Spoiler ad incollaggio, particolarmente consigliato anche per la scantonatura frigo, essendo rinforzato a griglia su tutta la parte centrale e su tutti i fianchi esterni.*

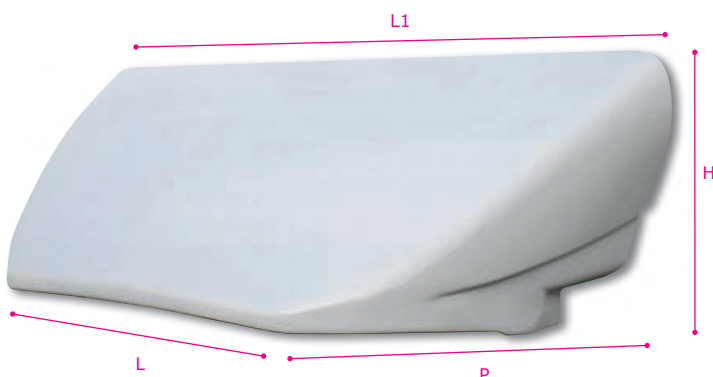

## Spoiler Renault Master Mascott - Movano >2010 Nissan NV400 >2014

ARTICLE	L	L1	H	P	KG	
SM2010	1450	1880	680	810	13,50	3



**Bonding Kit Included**  
Kit Incollaggio compreso



# Spoiler

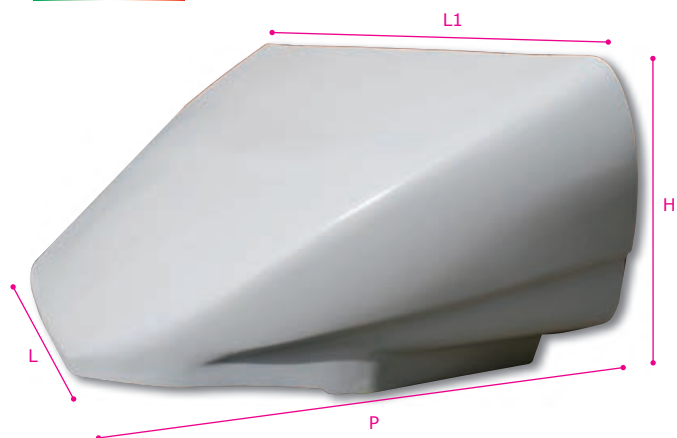

## Spoiler Mercedes Sprinter >2006 Volkswagen Crafter >2006 - 2017

ARTICLE	L	L1	H	P	KG	
S10016	1530	1920	700	800	11,50	3



**Bonding Kit Included**  
Kit Incollaggio compreso

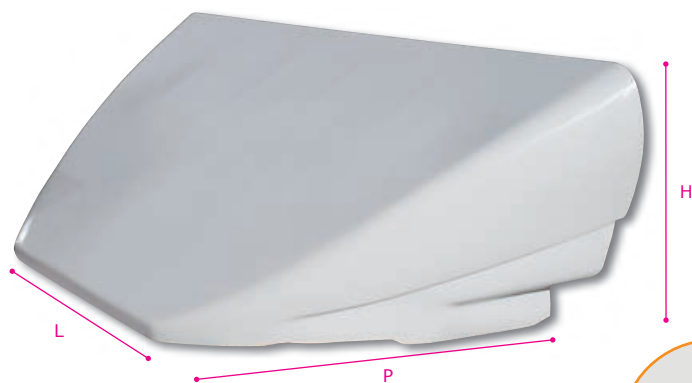

## Volkswagen Crafter >2018 Man TGE >2018

ARTICLE	L	L1	H	P	KG	
S10038	1520	1880	710	760	14,50	1

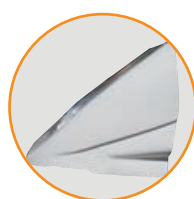

**Bonding Kit Included**  
Kit Incollaggio compreso

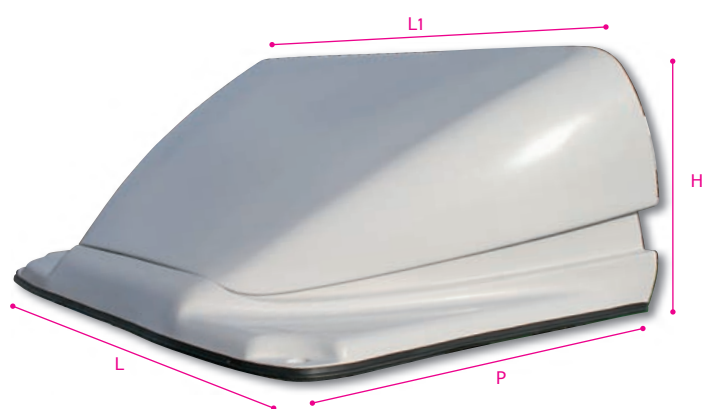
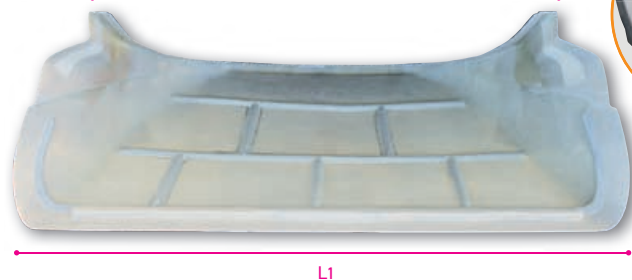

## Spoiler New Eurocargo >2003 Narrow Cabin Adjustable

*Regolabile Cabina Corta*

ARTICLE	L	L1	H	P	KG	
S3105	1900	1930	650-800	1100	29,00	1

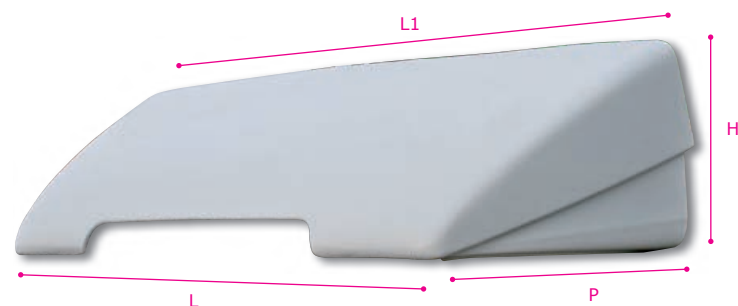

## Spoiler Mercedes Atego >2009 Low Top Adjustable

*Tetto Basso*

ARTICLE	L	L1	H	P	KG	
S3410	1600	2300	700-850	1200	13,00	1



## Spoiler Nissan Cabstar >2006 Renault Maxity >2009

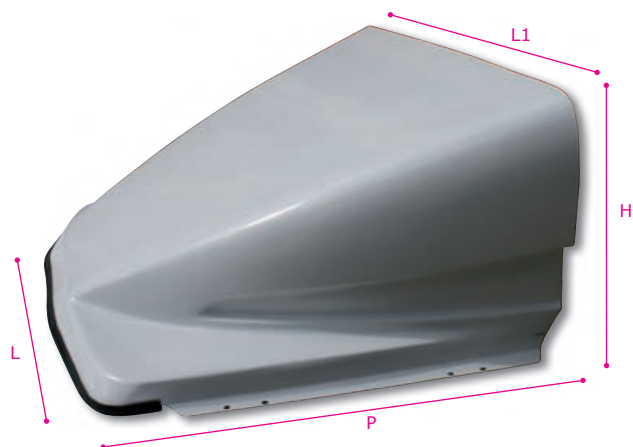

ARTICLE	L	L1	H	P	KG	
S10934	1670	1940	740	990	15,00	1

**i** Spoiler supplied without hardware, it uses the existing hardware on the top of the vehicle cabin.  
 Spoiler fornito senza ferramenta, viene utilizzata la bulloneria esistente nel sovracabina del mezzo.

## Spoiler Nissan NT500 >2014 Renault T >2014 Height Adjustable

*Regolabile in Altezza*

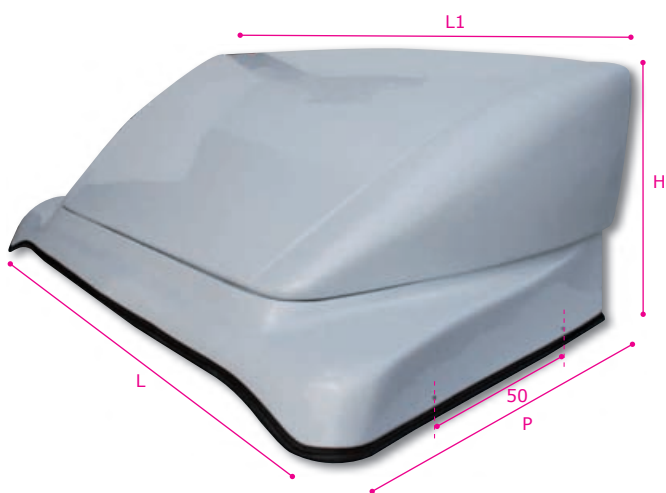

ARTICLE	L	L1	H	P	KG	
S10050	1850	1890	700-950	1030	24,00	1

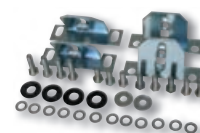
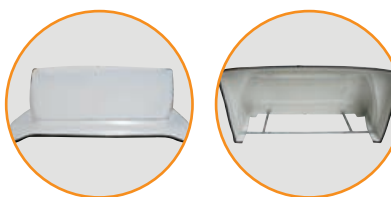

**Hardware Kit Included**  
 Kit Ferramenta compreso

## Spoiler Mitsubishi Canter >2005 Mitsubishi Canter FUSO FE >2017

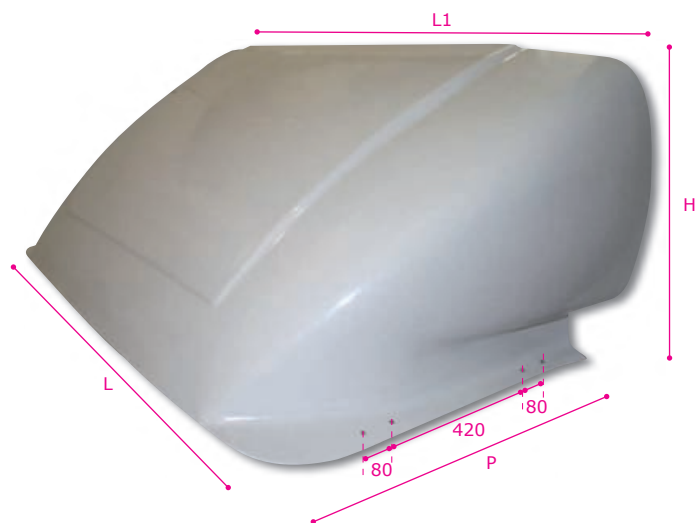

ARTICLE	L	L1	H	P	KG	
S10013	1700	1940	780	970	13,80	1



**Hardware Kit Included**  
 Kit Ferramenta compreso

## Spoiler Isuzu EVO-NNR-NPR >2009

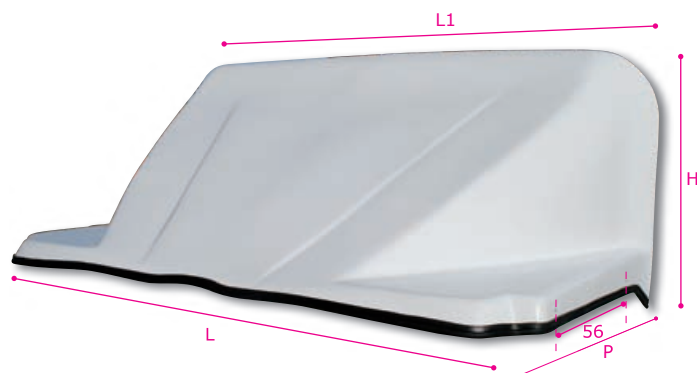

ARTICLE	L	L1	H	P	KG	
S10395 Large Cabin Cabina Larga	1800	1900	800	980	18,00	1
S10396 Narrow Cabin Cabina Stretta	1600	1700	700	900	16,50	1



**Hardware Kit Included**  
 Kit Ferramenta compreso



## Thixotropic Sealant – Cartridge 300 ml

*Sigillante Tixotropico in Cartuccia da 300 ml*

ARTICLE	DESCRIPTION	KG	
T75102	Cartridge Sealant 212FC - White/Sigillante cartuccia 212FC BIANCO	0,43	12
T75105	Cartridge Sealant 212FC - Grey/Sigillante cartuccia 212FC GRIGIO	0,43	12

### Areas of Application/Campi di applicazione

Sikaflex®-212 FC is a universal sealant suitable for most sealing applications in industrial commercial vehicle construction. The product possesses excellent sealing properties and bonds well to most materials commonly used in the commercial vehicle industry e.g. metals, plastics, wood and glass.

Sikaflex®-212 FC è un sigillante universale idoneo alla maggior parte delle applicazioni di sigillatura nel settore della costruzione di veicoli commerciali. Il prodotto è caratterizzato da eccellenti proprietà sigillanti ed aderisce bene ai materiali comunemente in uso nell'industria dei veicoli commerciali, ad esempio metalli, plastiche, legno e vetro.

### Product Benefit/Vantaggi

- Bonds well to a wide variety of substrates/Aderisce bene ad un'ampia gamma di substrati
- Can be painted over /Sovraverniciabile
- Elastic/Elastico
- Low emission of odours/Bassa emissione di odori
- Can be sanded/Carteggiabile



## Primer *Primer*

ARTICLE	DESCRIPTION	KG	
T1419	Generic Primer 250 ml/Primer generico flacone da 250 ml.	0,23	6
T113422	Generic Primer 1000 ml/Primer generico flacone da 1000 ml.	0,69	4



## Thixotropic Sealant – Unipack 600 ml

*Sigillante Tixotropico in Salsiccio da 600 ml*

ARTICLE	DESCRIPTION	KG	
T55770	Unipack Sealant - 212FC White/Sigillante unipak -212FC BIANCO	0,78	20
T73042	Unipack Sealant - 212FC Grey/Sigillante unipak -212FC GRIGIO	0,78	20
T73044	Unipack Sealant - 212FC Black/Sigillante unipak -212FC NERO	0,78	20

### Areas of Application/Campi di applicazione

Sikaflex®-212 FC is a universal sealant suitable for most sealing applications in industrial commercial vehicle construction. The product possesses excellent sealing properties and bonds well to most materials commonly used in the commercial vehicle industry e.g. metals, plastics, wood and glass.

Sikaflex®-212 FC è un sigillante universale idoneo alla maggior parte delle applicazioni di sigillatura nel settore della costruzione di veicoli commerciali. Il prodotto è caratterizzato da eccellenti proprietà sigillanti ed aderisce bene ai materiali comunemente in uso nell'industria dei veicoli commerciali, ad esempio metalli, plastiche, legno e vetro.

### Product Benefit/Vantaggi

- Bonds well to a wide variety of substrates/Aderisce bene ad un'ampia gamma di substrati
- Can be painted over /Sovraverniciabile
- Elastic/Elastico
- Low emission of odours/Bassa emissione di odori
- Can be sanded/Carteggiabile



## Mono Component Sealant Cartridge 300 ml

*Monocomponente in Cartuccia da 300 ml*

ARTICLE	DESCRIPTION	KG	
T4392	Cartridge Sealant -221 White/Sigillante cartuccia -221 BIANCO	0,43	12
T4390	Cartridge Sealant -221 Grey/Sigillante cartuccia -221 GRIGIO	0,43	12
T4393	Cartridge Sealant -221 Black/Sigillante cartuccia -221 NERO	0,43	12

### Areas of Application/Campi di applicazione

Sikaflex®-221 bond well to a wide variety of substances and suitable to realize permanently elastic high power sealing. Suitable substances are wood, metal, primer for metal and painting systems (bicomponent system) ceramic and plastic materials.

Sikaflex®-221 aderisce bene ad un'ampia gamma di substrati ed è adatto alla realizzazione di sigillature permanentemente elastiche ad alto potere adesivo. Substrati idonei sono legno, metallo, primer per metalli e sistemi di verniciatura (sistemi bicomponenti), materiali ceramici e plastici.

### Product Benefit/Vantaggi

- Mono Component/Monocomponente
- Elastic/Elastico
- Low emission of odours/Bassa emissione di odori
- Resistant to Ageing/Resistente all'invecchiamento
- Non corrosive/Non corrosivo
- Can be painted over and sanded/Sovraverniciabile e carteggiabile
- Bond well with a wide variety of substances/Aderisce bene ad un'ampia gamma di substrati

## Aluminum Manual Caulk Gun

*Pistola Manuale in Alluminio*



ARTICLE	DESCRIPTION	KG	
T4700	Aluminum tube caulk gun/Pistola manuale a tubo in alluminio	0,55	1

### Characteristic/Caratteristiche

Aluminum tube caulk gun for cartridge and unipack 300-400 and 600ml.

Professional, handy, safe, light and economic

Pistola manuale a tubo in alluminio per cartucce e unipak da 300-400 e 600 ml.

Professionale, pratica, sicura, leggera ed economica.

## Aluminum Manual Caulk Gun

*Pistola Manuale in Alluminio*



ARTICLE	DESCRIPTION	KG	
T4705	Compressed air pneumatic caulk gun/Pistola pneumatica ad aria compressa	1,40	1

### Characteristic/Caratteristiche

Pneumatic caulk gun for unipack 600ml. Compressed air model with pressure regulator and airflow valve system.

Pistola pneumatica per unipack da 600 ml. Modello ad aria compressa con regolatore della pressione e sistema con valvola di deflusso dell'aria.

# Lateral Marker Lamps



## Led Marker Lamp 12/24V with Cable 50 cm and Click-In

Luce Ingombro 12/24V a LED con Cavo 50 cm e Click-In



ARTICLE	M CABLE	L	H	P	i	KG	
305Z05	0,5	100	65	35	85	0,9	100
305Z15	1,5	100	65	35	85	0,10	100

ARTICLE	L	H	P	i	KG	
306P22	100	45	15	85	0,05	100

ARTICLE	L	H	P	i	KG	
307P22	100	45	15	85	0,05	100

Bracket supplied disassembled.  
Staffa fornita smontata.

## 4 Led Marker Lamp 12/24V with Cable 50 cm

Luce Ingombro 12/24V a 4 LED con Cavo da 50 cm



ARTICLE	L	H	P	i	KG	
SM0030G	130	50	30	115	0,07	100

ARTICLE	L	H	P	i	KG	
M0031B	130	35	15	115	0,05	100

ARTICLE	L	H	P	i	KG	
M0032R	130	35	15	115	0,05	100

Bracket supplied disassembled. With click-in.  
Staffa fornita smontata. Con click-in.

## 2 Led Marker Lamp 24V COBO

Luce Ingombro 24V a 2 LED Cobo

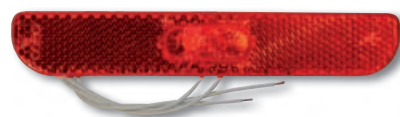
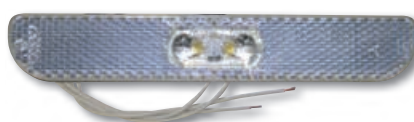

ARTICLE	L	H	i	KG	
040576	140	25	15	0,08	100

ARTICLE	L	H	i	KG	
030710 Adhesive Adesivo	140	25	0	0,08	100
030714 Screw Vite	140	25	160	0,08	100

ARTICLE	L	H	i	KG	
021503 Adhesive Adesivo	140	25	0	0,08	100
021507 Screw Vite	140	25	160	0,08	100

# Lateral Marker Lamps



## 4 Led Marker Lamp 24V with Flat Cable 2x15

*Luce Ingombro 24V a 4 LED con Cavo Piatto 2x15*

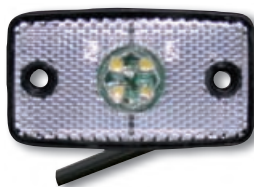

ARTICLE	MT. CABLE	L	H	P	i	KG	
040538	0,5	85	55	35	60	0,08	100
040544	1,5	85	55	35	60	0,08	100

ARTICLE	L	H	P	i	KG	
030642	85	45	35	60	0,06	100

ARTICLE	L	H	P	i	KG	
021257	85	45	35	60	0,06	100

## 1 Led Marker Lamp 24V with Cable 50 cm and Click-In

*Luce Ingombro 24V a 1 LED con Cavo da 50 cm e Click-In*



ARTICLE	MT. CABLE	L	H	P	i	KG	
1223705	0,5	95	30	65	70	0,11	100

ARTICLE	MT. CABLE	L	H	P	i	KG	
1224205	0,5	95	30	65	70	0,11	100

## 6 Led Marker Lamp 24V with Cable 30 cm

*Luce Ingombro 24V a 6 LED con Cavo da 30 cm*



ARTICLE	L	H	P	i	KG	
M0087	95	20	5	85	0,01	10

ARTICLE	L	H	P	i	KG	
M0088	95	20	5	85	0,01	10

ARTICLE	L	H	P	i	KG	
M0089	95	20	5	85	0,01	10

## 6 Led Marker Lamp 24V with Cable 30 cm

*Luce Ingombro 24V a 6 LED con Cavo da 30 cm*



ARTICLE	L	H	P	i	KG	
M0208	95	20	5	85	0,01	10

ARTICLE	L	H	P	i	KG	
M0209	95	20	5	85	0,01	10

# Lateral Marker Lamps



## Marker Lamp 12/24V

Luce Ingombro 12/24V a Lampada



ARTICLE	L	H	i	KG	
1202936	110	40	50	0,07	100



ARTICLE	L	H	i	KG	
1202937	110	40	45	0,05	100

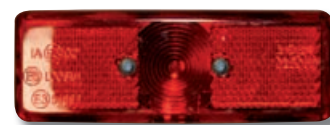

ARTICLE	L	H	i	KG	
1202938	110	40	45	0,05	100

## 2 Led Marker Lamp 12/24V with Cable 30 cm

Luce Ingombro 12/24V a 2 LED con Cavo da 30 cm



ARTICLE	L	H	P	i	KG	
1202947001	85	20	30	60	0,04	100



ARTICLE	L	H	P	i	KG	
1202947002	85	20	30	60	0,04	100

## 8 Led Homologated Third Stop Lamp 12/24V Screw Fixing

Luce Terzo Stop 12/24V a 8 LED Omologato a Vite



ARTICLE	L	H	P	i	KG	
021518 <sub>12V</sub>	180	25	13	160	0,03	1
021519 <sub>24V</sub>	180	25	13	160	0,03	1

## 8 Led Homologated Third Stop Lamp 12/24V Adesive Fixing

Luce Terzo Stop 12/24V a 8 LED Omologato Adesivo

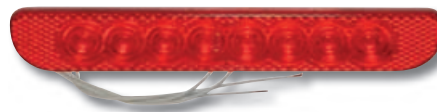

ARTICLE	L	H	P	KG	
021514 <sub>12V</sub>	140	25	13	0,03	1
021515 <sub>24V</sub>	140	25	13	0,03	1

## Led Ceiling 550 Lumen 12/24V IP65 -20°C + 40°C

Plafoniera LED 550 Lumen 12/14V IP65 -20°C + 40°C

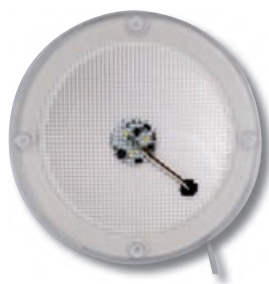

ARTICLE	D	P	i	KG	
100096	185	10	115	0,15	1

## Led Ceiling 500 Lumen 12/24V with Switch

Plafoniera LED 500 Lumen con Interruttore



ARTICLE	L	H	P	i	KG	
108841 <sub>12V</sub>	150	75	20	135	0,12	1
108842 <sub>24V</sub>	150	75	20	135	0,12	1



## Led Marker Lamp 12/24V White/Orange/Red

Luce Ingombro 12/24V a LED Bianco/Arancio/Rosso



ARTICLE	L	H	i	KG	
P0083	25	125	15	0,05	1



ARTICLE	L	H	i	KG	
P0082	25	125	15	0,05	1



ARTICLE	L	H	i	KG	
P0081	25	125	15	0,05	1

## Led Marker Lamp 12/24V White/Red

Luce Ingombro 12/24V a LED Bianco/Rosso



ARTICLE	L	H	i	KG	
P0024	25	125	15	0,05	1

## Led Marker Lamp 12/24V White/Red

Luce Ingombro 12/24V a LED Bianco/Rosso



ARTICLE	L	H	i	KG	
P0078	25	125	15	0,05	1

## Reverse 12/80V 110dB Buzzer

Segnalatore Acustico di Retromarcia 12/80V - 110dB



ARTICLE	L	H	i	KG	
F75064	105	85	100	0,08	1

## Led Work Lamp 10/30V 700 Lumen

Faro Lavoro LED 10/30V 700 LUMEN



ARTICLE	L	H	P	KG	
SS80007	100	100	40	0,44	1

EMC/ECE 1967 - 1 year warranty. EMC/ECE 1967 - Un anno di garanzia.

## Led Work Lamp 12/24V 1250 Lumen 5 Led

Faro Lavoro LED 12/24V 1250 LUMEN 5 Led



ARTICLE	L	H	P	KG	
5004301	110	145	45	0,65	1

## Led Work Lamp 12/24V 600 Lumen

Faro LED 12/24V 600 LUMEN



ARTICLE	D	H	KG	
05005901	115	35	0,44	1

## Led Work Lamp 12/24V 1500 Lumen

Faro LED 12/24V 1500 LUMEN



ARTICLE	D	H	KG	
05006201	150	70	0,88	1

Handle and switch. Maniglia ed interruttore.



# Rotating Beacons



## Lamp Rotating Beacon 12/24V

Girofaro a Lampada 12/24V



ARTICLE	D	H	i	KG	
35.400.000.01	155	200	113	0,63	1

Fixing with 3 screws. *Fissaggio con 3 viti.*



ARTICLE	D	H	KG	
35.406.000.01	155	185	1,13	1

Magnetic fixing. *Fissaggio magnetico.*



ARTICLE	D	H	KG	
35.408.000.01	155	285	0,94	1

Fixing with tubular support.  
*Fissaggio con supporto tubolare.*

ARTICLE	D	H	KG	
35.001.520.01	25	145	0,40	1

## Led Rotating Beacon 9/36V - ECE REG.65

Girofaro Flash a LED 9/36V - ECE REG.65



ARTICLE	D	H	i	KG	
35.8002.0000.01	155	85	115	0,75	1

Fixing with 3 screws. *Fissaggio con 3 viti.*



ARTICLE	D	H	KG	
35.8004.0000.01	155	105	1,30	1

Magnetic fixing. *Fissaggio magnetico.*



ARTICLE	D	H	KG	
35.8006.0000.01	155	190	0,90	1

Fixing with tubular support.  
*Fissaggio con supporto tubolare.*

ARTICLE	D	H	KG	
35.001.520.01	25	145	0,40	1

## Led Light Bars 12/24V

Barra Luminosa a LED 12/24V



ARTICLE	L	H	P	i	KG	
358052	1550	185	202	1142	4,60	1

4 modules Bi-Xenon. *4 moduli Bi-Xenon.*



ARTICLE	L	H	P	KG	
359002 3 MODULES/Moduli	900	45	210	6,80	1

359004 5 MODULES/Moduli	1200	45	210	8,90	1
-------------------------	------	----	-----	------	---

359006 7 MODULES/Moduli	1550	45	210	10,20	1
-------------------------	------	----	-----	-------	---

# Marker Lamps



## Marker Lamp 12/24V

Luca Ingombro 12/24 a Lampada



ARTICLE	L	P	i	KG	
F35258	190	50	75	0,03	1

**i** White/Red lens 90°. Lente 90° Bianca/Rossa.



ARTICLE	L	P	i	KG	
F35256	190	50	75	0,03	1

**i** White/Red lens 45°. Lente 45° Bianca/Rossa.



ARTICLE	L	P	i	KG	
F35272	85	50	75	0,02	1

**i** White/Red lens flat. Lente piatta Bianca/Rossa.

## Led Marker Lamp 24V with Colorless Lens

Luca Ingombro 24 a LED con Lente Incolore

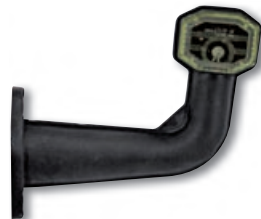

ARTICLE	L	P	i	KG	
12243	185	50	75	0,17	1

**i** Colorless lens 90°. Lente incolore 90°.



ARTICLE	L	P	i	KG	
12264	175	50	75	0,15	1

**i** Colorless lens 45°. Lente incolore 45°.



ARTICLE	L	P	i	KG	
1240168004	115	50	75	0,13	1

**i** Straight colorless lens. Lente incolore dritta.

## Led Marker Lamp 12/24V with Cable 50 cm

Luca Ingombro 12/24 a LED con Cavo 50 cm



ARTICLE	DIR	L	P	i	KG	
G0096	DX	190	50	75	0,21	1
G0097	SX	190	50	75	0,21	1

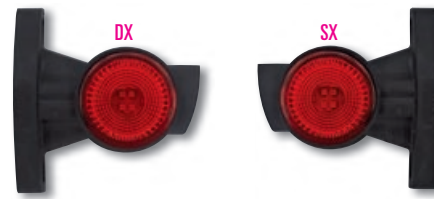

ARTICLE	DIR	L	P	i	KG	
G0094	DX	95	50	75	0,14	1
G0095	SX	95	50	75	0,14	1

## Led Marker Lamp 12/24

Luca Ingombro 12/24 a LED



ARTICLE	DIR	L	P	i	KG	
SS61012	DX	100	60	75	0,19	1
SS61011	SX	100	60	75	0,19	1

**i** Horizontal version. Versione orizzontale.



ARTICLE	DIR	L	P	i	KG	
SS61022	DX	100	60	75	0,19	1
SS61021	SX	100	60	75	0,19	1

**i** Vertical version. Versione verticale.

# Licence Plate Lamps



ARTICLE	L	H	P	i	KG	
T0013N	100	55	55	70	0,20	1

**i** 24V with cable 50 cm. and click-in.  
24V con cavo 50 cm. e click-in.



ARTICLE	L	H	P	i	KG	
T0013R	100	55	55	70	0,20	1

**i** 24V with cable 50 cm. and click-in.  
24V con cavo 50 cm. e click-in.

## Led Licence Plate Lamp

Fanali Targa a LED



ARTICLE	L	H	P	i	KG	
LT0027N	80	40	30	45	0,06	1

**i** Led 12/24V with cable 20 cm.  
Led 12/24V con cavo 20 cm.

## Licence Plate Lamp

Fanali Targa a Lampada



ARTICLE	L	H	P	i	KG	
F39024 <small>With screw Con vite</small>	115	60	65	65	0,12	1
F39040 <small>With click Con click</small>	115	60	65	65	0,12	1



ARTICLE	L	H	P	i	KG	
T0408N	100	55	55	70	0,20	1

**i** Cable 0,2 mt.  
Cavo 0,2 mt.



ARTICLE	L	H	P	i	KG	
12170	100	60	55	70	0,14	1

**i** Cable 0,5 mt. and click-in.  
Cavo 0,5 mt e click-in.

## Licence Plate Lamp

Fanali Targa a Lampada



ARTICLE	L	H	P	i	KG	
12171	100	60	55	70	0,14	1



ARTICLE	L	H	P	i	KG	
F39002	85	35	30	45	0,05	1



ARTICLE	L	H	i	KG	
F76046R	156	136	70	0,02	1

**i** Triangular reflex reflector with 2 screws.  
Triangolo catarifrangente con 2 viti.

## White Reflex Reflector

Catarifrangente Bianco



Adhesive Adesivo	With screw Con vite	D	KG	
12.009	12.003	60	0,015	1
12.012	12.018	80	0,017	1

## Red Reflex Reflector

Catarifrangente Rosso



Adhesive Adesivo	With screw Con vite	D	KG	
12.007	12.001	60	0,015	1
12.010	12.016	80	0,017	1

## Orange Reflex Reflector

Catarifrangente Arancio



Adhesive Adesivo	With screw Con vite	D	KG	
12.008	12.002	60	0,015	1
12.011	12.017	80	0,017	1

# Rear Lamps for Trailers

## Homologated Led Rear Lamp 12/24V ECE-EMC

Fanale Led 12/24V Omologato ECE-EMC



ARTICLE	L	H	P	i	KG	
SS47400	190	50	35	75	0,16	1

**i** Stop/Tail/Reverse/Turn signal.  
Stop/Posizione/Retromarcia/Freccia.

ARTICLE	L	H	P	i	KG	
SS46300	190	50	35	75	0,16	1

**i** Stop/Tail/Turn signal.  
Stop/Posizione/Freccia.

## Multi-Function Full Led Rear Lamp 12/24V

Fanale Full Led 12/24V Multifunzione



SX

DX

ARTICLE	DIR	L	H	P	i	KG	
22101	DX	250	130	30	150	0,64	1
22202	SX	250	130	30	150	0,64	1

## Multi-Function Full Led Rear Lamp 12/24V - ADR

Fanale Full Led 12/24V Multifunzione - ADR

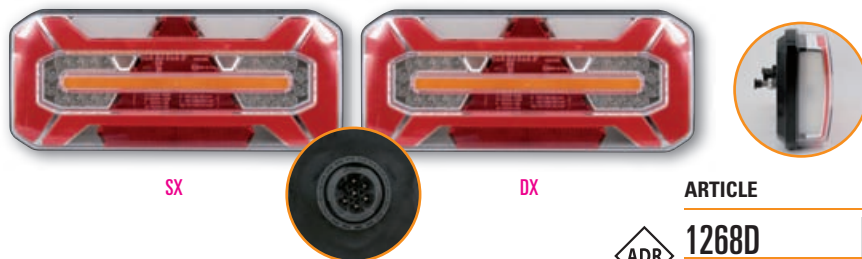

SX

DX



ARTICLE	DIR	L	H	P	i	KG	
1268D	DX	305	130	55	150	1	1
1266S	SX	305	130	55	150	1	1

## Full Led Rear Lamp 24V - IP69K

Fanale Full Led 24V - IP69K



SX

DX



DIN EU

ARTICLE	DIR	L	H	P	i	KG	
9005104	DX	400	135	50	150	2,00	1
9005105	SX	400	135	50	150	2,00	1

ECE EMC ADR homologated with integrated electronics.  
ECE EMC ADR omologato elettronica integrata.

## Rear Lamp 24V

Fanale Lampada 24V



SX

DX

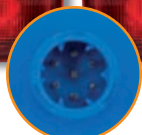

ARTICLE	DIR	L	H	P	i	KG	
1204633000	DX	410	162	85	150	1,40	1
1204634000	SX	410	162	85	150	1,40	1

ARTICLE	L	H	P	i	KG	
1204633036 LENS DX GEMMA DX	410	162	20	-	0,03	1
1204634036 LENS SX GEMMA SX	410	162	20	-	0,03	1

# Rear Lamp for Trailers



SX

DX



UNIVERSAL CABLE CONNECTOR ASPOCK  
CONNETTORE UNIVERSALE ASPOCK



## Europoint I Rear Lamp

*Fanale Europoint I*

ARTICLE	DIR	L	H	P	i	KG	
F37800	DX	420	140	90	150	1,20	1
F37801	SX	420	140	90	150	1,20	1
F37800D	LENS GEMMA	420	140	40	-	0,04	1

0312126

## Europoint II Rear Lamp

*Fanale Europoint II*



SX

DX



UNIVERSAL CABLE CONNECTOR ASPOCK  
CONNETTORE UNIVERSALE ASPOCK



ARTICLE	DIR	L	H	P	i	KG	
12231	DX	420	150	85	150	1,55	1
12232	SX	420	150	85	150	1,55	1
12233	LENS GEMMA	420	150	40	-	0,04	1

0312126

## Europoint III Rear Lamp

*Fanale Europoint III*



SX

DX



UNIVERSAL CABLE CONNECTOR ASPOCK  
CONNETTORE UNIVERSALE ASPOCK



ARTICLE	DIR	L	H	P	i	KG	
7400507	DX	400	155	90	150	1,30	1
7000507	SX	400	155	90	150	1,30	1
570101	LENS DX GEMMA DX	400	155	60	-	0,04	1
570001	LENS SX GEMMA SX	400	155	60	-	0,04	1

0312126

## New Ecopoint I Rear Lamp

*Fanale New Ecopoint I*



SX

DX



UNIVERSAL CABLE CONNECTOR ASPOCK  
CONNETTORE UNIVERSALE ASPOCK



ARTICLE	DIR	L	H	P	i	KG	
2600717	DX	340	135	80	150	1,00	1
2200717	SX	340	135	80	150	1,00	1
8522002	LENS GEMMA	340	135	20	-	0,03	1

0312126

Stop/Tail/Turn signal led. *Stop/Posizione/Freccia Led.*

## New Ecopoint II Rear Lamp

*Fanale New Ecopoint II*



SX

DX



UNIVERSAL CABLE CONNECTOR ASPOCK  
CONNETTORE UNIVERSALE ASPOCK



ARTICLE	DIR	L	H	P	i	KG	
2900507	DX	350	135	90	150	1,17	1
2800507	SX	350	135	90	150	1,17	1
8529002	LENS DX GEMMA DX	340	135	50	-	0,03	1
8528002	LENS SX GEMMA SX	340	135	50	-	0,03	1

0312126

# Rear Lamps for Tractors

## 5 Functions Rear Lamp

Fanale 5 Funzioni



ARTICLE	DIR	L	H	P	i	KG	
F37082 UNIV.	DX	310	130	85	190	0,75	1
F37083 UNIV.	SX	310	130	85	190	0,75	1



F37122	DX	310	130	85	190	0,75	1
F37123	SX	310	130	85	190	0,75	1
F37150	DX	310	130	85	190	0,75	1
F37151	SX	310	130	85	190	0,75	1

F37082D	LENS DX GEMMA DX	310	130	20	-	0,02	1
F37083S	LENS SX GEMMA SX	310	130	20	-	0,02	1

## Rear Lamp for Daily 2009

Fanale Daily 2009



ARTICLE	DIR	L	H	P	i	KG	
021473	DX	310	130	85	190	0,70	1
021472	SX	310	130	85	190	0,70	1
02147302	LENS DX GEMMA DX	310	130	20	-	0,02	1
02147202	LENS SX GEMMA SX	310	130	20	-	0,02	1

## 7 Functions Rear Lamp for Iveco

Fanale 7 Funzioni Iveco

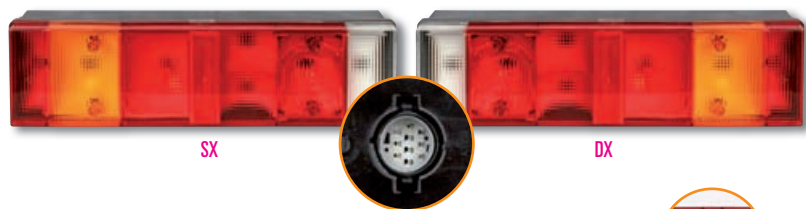

ARTICLE	DIR	L	H	P	i	KG	
F37650	DX	470	130	80	190	1,17	1
F37651	SX	470	130	80	190	1,17	1
F37653	SX	470	130	80	190	1,17	1

WITH LICENCE PLATE LAMP  
CON LUCE TARGA



F37140D	LENS DX-SX GEMMA DX-SX	470	130	20	-	0,03	1
---------	---------------------------	-----	-----	----	---	------	---

## Rear Lamp for Master Mascott Midlum

Fanale Posteriore Master Mascott Midlum



ARTICLE	L	H	P	i	KG		
F37580	345	130	85	150	0,66	1	
F37580D	LENS DX-SX GEMMA DX-SX	345	130	30	-	0,02	1

# Rear Lamps for Tractors



## 5 Functions Full Led Rear Lamp 12/24V

Fanale Full Led 12/24V 5 Funzioni

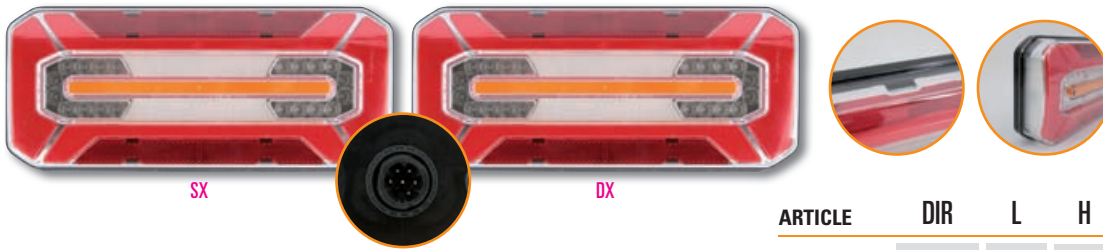

ARTICLE	DIR	L	H	P	i	KG	
1290LPT	DX-SX	305	130	55	150	1	1

## 5 Functions Full Led Rear Lamp 12/24V

Fanale Full Led 12/24V 5 Funzioni



ARTICLE	DIR	L	H	P	i	KG	
1111LP200	DX-SX	230	100	40	150	0,65	1

## Multi-Function Full Led Rear Lamp 12/24V

Fanale Full Led 12/24V Multifunzione



ARTICLE	DIR	D	P	i	KG	
1128200	DX-SX	140	35	45	0,40	1

## Multi-Function Full Led Rear Lamp 12/24V

Fanale Full Led 12/24V Multifunzione

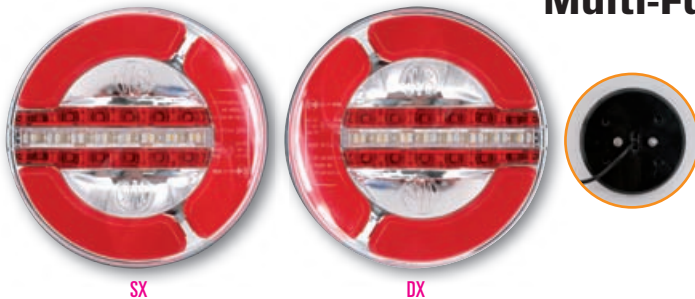

ARTICLE	DIR	D	P	i	KG	
11302F200	DX-SX	140	35	45	0,40	1

## 1 Led Marker Lamp 12/24V

Luce Ingombro 12/24V 1 Striscia Led



ARTICLE	DIR	L	H	P	i	KG	
184KR38	DX-SX	235	20	23	212	0,10	1

## Flashing Light for Tail Lift

Lampeggiante Universale per Sponde Idrauliche



ARTICLE	L	L1	P	i	KG	
1126300	105	90	14	84	0,25	1



## PVC Cable Ties

Fascette PVC a Strappo



ARTICLE	H x L	KG	
A1	2,5x160	0,049	100
A10	3,6x150	0,061	100
A16	4,8x200	0,131	100

ARTICLE	H x L	KG	
A12	4,8x280	0,201	100
A20	4,8x360	0,270	100
A30	7,6x360	0,467	100

ARTICLE	H x L	KG	
A18	7,6x450	0,584	100
A31	7,6x540	0,804	100
A32	7,6x750	1,118	100

## Plastic Fixing Clamp

Fascetta in Plastica



ARTICLE	Ø Hole Plate Ø Foro Lamiera	D	KG	
A2	6	8	0,02	100

## Plastic Fixing Clamp

Fascetta in Plastica



ARTICLE	Ø Hole Plate Ø Foro Lamiera	D	KG	
A3	6	11	0,003	100

## Rubber Fixing Clamp

Fascetta in Gomma



ARTICLE	Ø Hole Plate Ø Foro Lamiera	D	KG	
D110	6,5	10	0,04	100

## Triangular Reflector with 2 Screws

Catarifrangente Triangolare con 2 Viti



ARTICLE	L	H	i	KG	
F76046R	156	136	85	0,12	1

## Black Insulating Tape

Nastro Isolante Nero



ARTICLE	L	H	KG	
65530	10	15	0,02	10

## Rayon Tape 25x25

Nastro Rayon 25x25

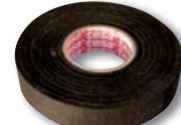

ARTICLE	L	H	KG	
13.005	25	15	0,20	10

## White Insulating Tape

Nastro Isolante Bianco



ARTICLE	L	H	KG	
65529	10	15	0,02	10

## Blue Insulating Tape

Nastro Isolante Blu

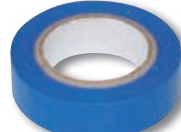

ARTICLE	L	H	KG	
65530B	10	15	0,02	10

## Red Insulating Tape

Nastro Isolante Rosso

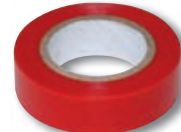

ARTICLE	L	H	KG	
65530R	10	15	0,02	10

## Flat Cable 2x1,5

Cavo Piatto 2x1,5



ARTICLE	L	H	KG	
17.603	100	4,5	5,07	1

## Lock Wire Connector Double Flat Cable

Ruba Corrente per Doppio Cavo Piatto



ARTICLE	L	H	KG	
250054	40	20	0,02	100

## Lock Wire Connector Flat / Stripped Cable

Ruba Corrente Cavo Piatto/Filo Spelato



ARTICLE	L	H	KG	
270930	40	20	0,02	100



# Reflecting Tapes



## Metallized Conspicuity Vehicle Marking for Rigid Surface ECE/ONU 104

*Nastro Riflettente Superfici Rigide Metallizzato*



ARTICLE	DESCRIPTION	H/ml	KG	
T40701	YELLOW/GIALLO	50x50	0,85	1

**i** Tape texture continuous stripes 8 mm.  
*Nastro continuo con texture a strisce 8 mm.*

## Metallized Conspicuity Vehicle Marking for Rigid Surface ECE/ONU 104

*Nastro Riflettente Superfici Rigide Metallizzato*



ARTICLE	DESCRIPTION	H/ml	KG	
T40702	WHITE/BIANCO	50x50	0,85	1

**i** Tape texture continuous stripes 8 mm.  
*Nastro continuo con texture a strisce 8 mm.*

## Metallized Conspicuity Vehicle Marking for Rigid Surface ECE/ONU 104

*Nastro Riflettente Superfici Rigide Metallizzato*



ARTICLE	DESCRIPTION	H/ml	KG	
T40703	RED/ROSSO	50x50	0,85	1

T40706	RED/ROSSO	50x12,5	0,55	1
--------	-----------	---------	------	---

**i** Tape texture continuous stripes 8 mm.  
*Nastro continuo con texture a strisce 8 mm.*

## Segmented Conspicuity Vehicle Marking for Curtainsider ECE/ONU 104

*Nastro Riflettente Segmentato Superfici Telonate*



ARTICLE	DESCRIPTION	H/ml	H/L	KG	
T50710	YELLOW/GIALLO	50x50	50x50	1,80	1

T50713	YELLOW/GIALLO	50x12,5	50x50	0,65	1
--------	---------------	---------	-------	------	---

**i** Segmented tape with honeycomb texture.  
*Nastro segmentato con texture a nido d'ape.*

## Segmented Conspicuity Vehicle Marking for Curtainsider ECE/ONU 104

*Nastro Riflettente Segmentato Superfici Telonate*



ARTICLE	DESCRIPTION	H/ml	H/L	KG	
T50711	WHITE/BIANCO	50x50	50x50	1,80	1

T50714	WHITE/BIANCO	50x12,5	50x50	0,65	1
--------	--------------	---------	-------	------	---

**i** Segmented tape with honeycomb texture.  
*Nastro segmentato con texture a nido d'ape.*

## Segmented Conspicuity Vehicle Marking for Curtainsider ECE/ONU 104

*Nastro Riflettente Segmentato Superfici Telonate*

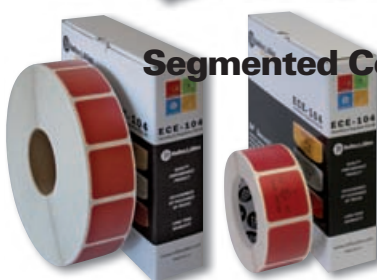

ARTICLE	DESCRIPTION	H/ml	H/L	KG	
T50712	RED/ROSSO	50x50	50x50	1,80	1

T50715	RED/ROSSO	50x12,5	50x50	0,65	1
--------	-----------	---------	-------	------	---

**i** Segmented tape with honeycomb texture.  
*Nastro segmentato con texture a nido d'ape.*

## Segmented Conspicuity Vehicle Marking for Tankers ECE/ONU 104

*Nastro Riflettente Segmentato Autocisterne*



ARTICLE	DESCRIPTION	H/ml	H/L	KG	
T50716	RED/ROSSO	50x12,5	50x105	0,45	1

**i** Segmented tape with honeycomb texture. *Nastro segmentato con texture a nido d'ape.*

# Reflecting Tapes



## Conspicuity Vehicle Marking for Rigid Surface ECE/ONU 104

*Nastro Riflettente Superfici Rigide Texture Esagonale*

ARTICLE	DESCRIPTION	H/ml	KG	
T50701	YELLOW/GIALLO	50x50	1,40	1
T50707	YELLOW/GIALLO	50x12,5	0,55	1

**i** Continuous tape with honeycomb texture.  
*Nastro continuo con texture a nido d'ape.*



## Conspicuity Vehicle Marking for Rigid Surface ECE/ONU 104

*Nastro Riflettente Superfici Rigide Texture Esagonale*

ARTICLE	DESCRIPTION	H/ml	KG	
T50702	WHITE/BIANCO	50x50	1,40	1
T50708	WHITE/BIANCO	50x12,5	0,55	1

**i** Continuous tape with honeycomb texture.  
*Nastro continuo con texture a nido d'ape.*



## Conspicuity Vehicle Marking for Rigid Surface ECE/ONU 104

*Nastro Riflettente Superfici Rigide Texture Esagonale*

ARTICLE	DESCRIPTION	H/ml	KG	
T50703	RED/ROSSO	50x50	1,40	1
T50709	RED/ROSSO	50x12,5	0,55	1

**i** Continuous tape with honeycomb texture.  
*Nastro continuo con texture a nido d'ape.*



## Conspicuity Vehicle Marking for Curtainsider ECE/ONU 104

*Nastro Riflettente Superfici Telonate Texture Esagonale*

ARTICLE	DESCRIPTION	H/ml	KG	
T50704	YELLOW/GIALLO	50x50	1,65	1

**i** Continuous tape with honeycomb texture.  
*Nastro continuo con texture a nido d'ape.*



## Conspicuity Vehicle Marking for Curtainsider ECE/ONU 104

*Nastro Riflettente Superfici Telonate Texture Esagonale*

ARTICLE	DESCRIPTION	H/ml	KG	
T50705	WHITE/BIANCO	50x50	1,65	1

**i** Continuous tape with honeycomb texture.  
*Nastro continuo con texture a nido d'ape.*



## Conspicuity Vehicle Marking for Curtainsider ECE/ONU 104

*Nastro Riflettente Superfici Telonate Texture Esagonale*

ARTICLE	DESCRIPTION	H/ml	KG	
T50706	RED/ROSSO	50x50	1,65	1

**i** Continuous tape with honeycomb texture.  
*Nastro continuo con texture a nido d'ape.*

# Panels and Speed Limit



## Self-Adhesive Speed Limit Disc

Disco Adesivo Limite Velocità

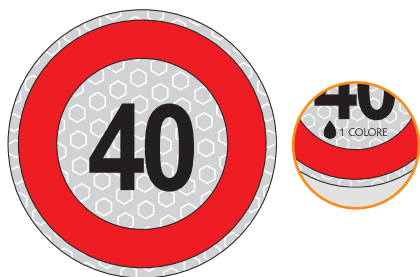

ARTICLE	DESCRIPTION	D	KG	
T99002	40 km/h	200	0,17	100
T99002P	40 km/h	200	0,17	100

## Self-Adhesive Speed Limit Disc

Disco Adesivo Limite Velocità

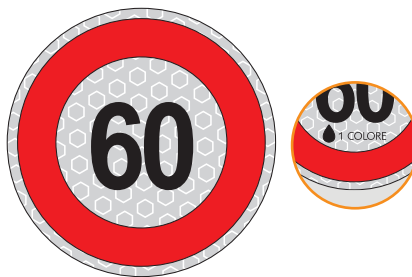

ARTICLE	DESCRIPTION	D	KG	
T99006	60 km/h	200	0,17	100
T99006P	60 km/h	200	0,17	100

## Self-Adhesive Speed Limit Disc

Disco Adesivo Limite Velocità

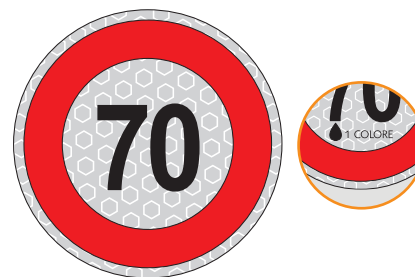

ARTICLE	DESCRIPTION	D	KG	
T99003	70 km/h	200	0,17	100
T99003P	70 km/h	200	0,17	100

## Self-Adhesive Speed Limit Disc

Disco Adesivo Limite Velocità

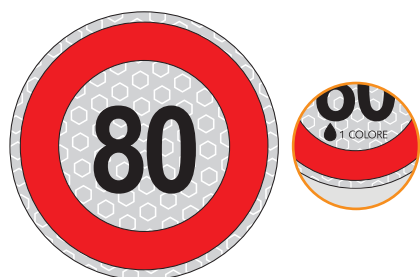

ARTICLE	DESCRIPTION	D	KG	
T99004	80 km/h	200	0,17	100
T99004P	80 km/h	200	0,17	100

## Self-Adhesive Speed Limit Disc

Disco Adesivo Limite Velocità

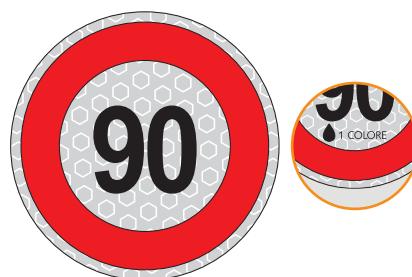

ARTICLE	DESCRIPTION	D	KG	
T990041	90 km/h	200	0,17	100
T990041P	90 km/h	200	0,17	100

## Self-Adhesive Speed Limit Disc

Disco Adesivo Limite Velocità



ARTICLE	DESCRIPTION	D	KG	
T99005	100 km/h	200	0,17	100
T99005P	100 km/h	200	0,17	100

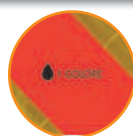

## Reflecting Panels for Truck

Coppia Pannelli Motrice

ARTICLE	L	H	SP	KG	
T90163	565	132	12/10	0,41	15
T90163P	565	132	12/10	0,41	15
T99207 Adhesive Adesivo	565	132	0	0,002	15
T99207P Adhesive Adesivo	565	132	0	0,002	15

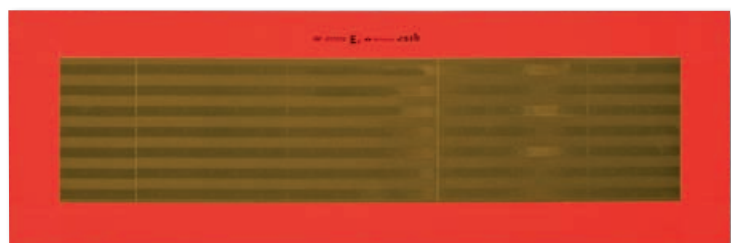

## Reflecting Panels for Trailer

Coppia Pannelli Rimorchio

ARTICLE	L	H	SP	KG	
T90183	565	196	12/10	0,62	15
T90183P	565	196	12/10	0,62	15
T99217 Adhesive Adesivo	565	196	0	0,002	15
T99217 Adhesive Adesivo	565	196	0	0,002	15



## Own Account Transport Adhesive

*Adesivo Trasporto Conto Proprio*



ARTICLE	L	H	KG	
T99311	155	245	0,03	1
T99311P	155	245	0,03	1
T99312	115	240	0,02	1
T99312P	115	240	0,02	1

**i** Obligatory on all vehicle, positioned anteriorly and posteriorly. Customizable.  
*E' obbligatorio su tutti i veicoli, posizionamento anteriore e posteriore. Personalizzabile.*

## Third-Party Transport Adhesive

*Adesivo Trasporto Conto Terzi*

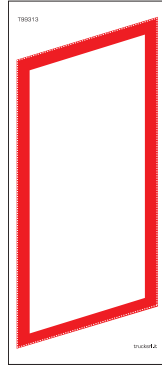

ARTICLE	L	H	KG	
T99310	155	245	0,03	1
T99310P	155	245	0,03	1
T99313	115	240	0,02	1
T99313P	115	240	0,02	1

**i** Obligatory on all vehicle, positioned anteriorly and posteriorly. Customizable.  
*E' obbligatorio su tutti i veicoli, posizionamento anteriore e posteriore. Personalizzabile sia in bianco e nero che a colori.*

## Adhesive By-product Cat. 3 Animal Origin

*Adesivo Trasporto Sottoprodotto Origine Animale Categoria 3*



ARTICLE	L	H	KG	
T99633	500	400	0,05	24

## Agricultural Load Transport Adhesive

*Adesivo Trasporto Merci Agricole*



ARTICLE	L	H	KG	
T99619	500	400	0,51	24
T99619P	500	400	0,51	24

## Agricultural Load Transport Adhesive

*Adesivo Trasporto Merci Agricole*



ARTICLE	D	KG	
T99626	380	0,04	24
T99626P	380	0,04	24

## Agricultural Load Transport Adhesive

*Adesivo Trasporto Merci Agricole*



ARTICLE	D	KG	
T99630	380	0,04	24
T99630P	380	0,04	24

## Perishable Load Transport Adhesive

*Adesivo Trasporto Prodotti Deperibili*



ARTICLE	L	H	KG	
T99620	500	400	0,51	24
T99620P	500	400	0,51	24

## Perishable Load Transport Adhesive

*Adesivo Trasporto Prodotti Deperibili*



ARTICLE	D	KG	
T99631	380	0,04	24
T99631P	380	0,04	24

## Perishable Load Transport Adhesive

*Adesivo Trasporto Prodotti Deperibili*



ARTICLE	D	KG	
T99632	380	0,04	24
T99632P	380	0,04	24

# Supports for ADR Panels

## Stainless Steel Signs Support for Tube Holder

Portacartello Inox per Tubi

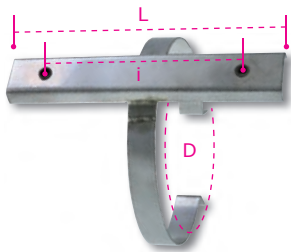

ARTICLE	L	i	D	KG	
T91220	285	205	150	0,70	1
T91221	285	205	200	0,80	1

**i** Threaded inserts 8x1,25.  
Inserti filettati 8x1,25.

## Stainless Steel Collar for Tube

Collare con Molla Inox per Portatubi

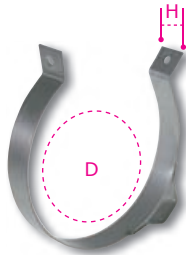

ARTICLE	H	D	KG	
T91224	30	150	0,20	100
T91225	30	200	0,22	100

## Stainless Steel Double Signs for Tube Holder

Supporto Doppio Cartello Inox per Portatubi

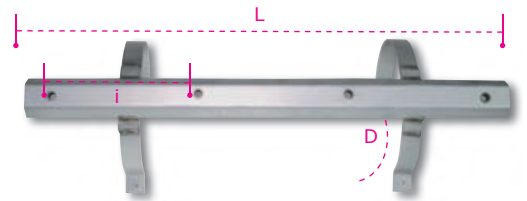

ARTICLE	L	i	D	KG	
T91222	710	205	150	1,60	1
T91223	710	205	200	1,75	1

**i** Threaded inserts 8x1,25.  
Inserti filettati 8x1,25.

## Stainless Steel Bar for A.D.R. Signs

Staffa Inox per Cartelli



ARTICLE	L	H	i	KG	
T91226	285	50	205	0,38	1

**i** Threaded inserts 8x1,25.  
Inserti filettati 8x1,25.

## Stainless Steel Bar for Double A.D.R. Signs

Staffa Inox per Doppio Cartello



ARTICLE	L	H	i	KG	
T91227	710	50	205	0,76	1

**i** Threaded inserts 8x1,25.  
Inserti filettati 8x1,25.

## Stainless Steel Omega Support for Signs

Supporto Inox ad Omega per Cartelli



ARTICLE	L	H	i	KG	
T91069	450	70	205	0,60	1

**i** Threaded inserts 8x1,25.  
Inserti filettati 8x1,25.

## Stainless Steel Omega Support for Double Signs

Supporto Inox Doppio ad Omega per Cartelli



ARTICLE	L	H	i	KG	
T91077	830	70	205	1,00	1

**i** Threaded inserts 8x1,25.  
Inserti filettati 8x1,25.

## Stainless Steel Sign Holder

Porta Cartello Inox con molla

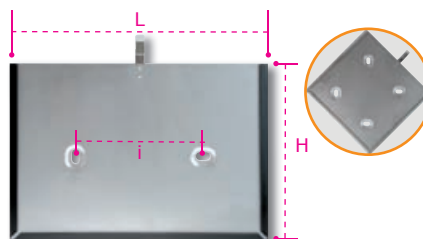

ARTICLE	L	H	i	KG	
T91067	400	300	205	0,80	1
T91071	300	300	205	0,60	1

**i** Slots 20x10. Asole 20x10.

## Aluminum Panel for A.D.R. Adhesive

Cartello Alluminio per Adesivi A.D.R.

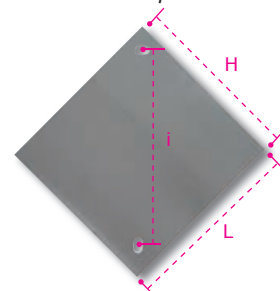

ARTICLE	L	H	i	KG	
T91073	300	300	330	0,24	1

**i** Slots for tourniquet 20x10. On request, special sizes Aluminum/Stainless Steel. Asole per tourniquet 20x10. Su richiesta misure speciali Alluminio/Acciaio Inox.

# Panels and PVC Adhesives



## A.D.R. Vertical Folding Panel Opening SX>DX

*Pannello A.D.R. Pieghevole Verticale Apertura Sx>Dx*



ARTICLE	L	H	SP	KG	
T91216	300	120	10/10	0,25	1

## A.D.R. Vertical Folding Panel Opening High>Low

*Pannello A.D.R. Pieghevole Apertura Alto>Basso*



ARTICLE	L	H	SP	KG	
T91207	400	300	10/10	0,43	1

## A.D.R. Vertical Folding Panel Opening SX>DX

*Pannello A.D.R. Pieghevole Verticale Apertura Sx>Dx*



ARTICLE	L	H	SP	KG	
T91209	400	300	10/10	0,40	1

## Protruding Loads Panel Homologated

*Pannello Carico Sporgente Omologato*



ARTICLE	L	H	KG	
T90079	500	500	0,84	1

**i** Homologated DIN 11030+ TP ESC-A 19035. Not customizable. *Omologato DIN 11030+ TP ESC-A 19035. Non personalizzabile.*

## Waste Transport Folding Panel

*Pannello Trasporto Rifiuti Pieghevole*



ARTICLE	L	H	KG	
T99623	400	400	0,95	6

## TIR Transport Marking

*Pannello TIR*



ARTICLE	L	H	KG	
T90111	400	250	0,65	6

## Dead Corner Panel Truck Adhesive

*Adesivo Angolo Morto per Camion*



ARTICLE	L	H	KG	
T90601 <b>Rigid Surface</b> Sup. Rigide	170	250	0,12	1
T90603 <b>Tarpaulin Surf.</b> Sup. Telonate	170	250	0,12	1
T90604 <b>Magnetic Surf.</b> Sup. Magnet.	170	250	0,30	1

**i** Printed on magnetic support, on PVC for tarpaulin surfaces, on PVC for rigid surfaces. *Stampato su supporto calamitato, per superfici telonate e rigide.*

## Dead Corner Panel Bus Adhesive

*Adesivo Angolo Morto per Bus*



ARTICLE	L	H	KG	
T90602	170	250	0,12	1

**i** Printed on magnet support, on PVC for telonate surfaces, on PVC for rigid surfaces. *Stampato su supporto calamitato, per superfici telonate e rigide.*

## Waste Transport Adhesive

*Adesivo Trasporto Rifiuti*



ARTICLE	L	H	KG	
T99621	400	400	0,03	1
T99622	150	150	0,01	1



**Flammable Liquids  
Class 2  
Transport Adhesive**  
*Adesivo Trasporto  
Liquidi Infiammabili Classe 2*



ARTICLE	L	H	KG	
T99628	300	300	0,02	24

**Flammable Liquids  
Class 3  
Transport Adhesive**  
*Adesivo Trasporto  
Liquidi Infiammabili Classe 3*



ARTICLE	L	H	KG	
T99602	300	300	0,02	24
T9960210	100	100	0,01	24

**Flammable Solids  
Class 4  
Transport Adhesive**  
*Adesivo Trasporto  
Solidi Infiammabili Classe 4*



ARTICLE	L	H	KG	
T99603	300	300	0,02	24

**Non Inflammable  
Compressed  
Gas Class 2  
Transport Adhesive**  
*Adesivo Trasporto Gas Compresso  
Non Infiammabile Classe 2*



ARTICLE	L	H	KG	
T99601	300	300	0,02	24

**Oxidizing Agent and  
Organic Peroxides  
Transport Adhesive**  
*Adesivo Trasporto Comburenti  
e Perossidi Organici*



ARTICLE	L	H	KG	
T99625	300	300	0,02	24

**Toxic Gas Class 2  
Transport Adhesive**  
*Adesivo Trasporto  
Gas Tossico Classe 2*



ARTICLE	L	H	KG	
T99629	300	300	0,02	24

**Corrosive  
Substances Class 8  
Transport Adhesive**  
*Adesivo Trasporto  
Sostanze Corrosive Classe 8*



ARTICLE	L	H	KG	
T99614	300	300	0,02	24

**General Danger  
Class 9  
Transport Adhesive**  
*Adesivo Trasporto  
Pericolosità Generica Classe 9*



ARTICLE	L	H	KG	
T99615	300	300	0,02	24

**Dangerous Substances  
for the Environment  
Transport Adhesive**  
*Adesivo Trasporto Materia Pericolosa  
per l'Ambiente Acquatico*



ARTICLE	L	H	KG	
T99639	300	300	0,02	24
T9963910	100	100	0,01	24



**Thermometer  
Over 20°C  
Class 9 Adhesive**

*Adesivo Termometro  
Superiore ai 20°C Classe 9*



ARTICLE	L	H	KG	
T99624	300	300	0,02	24

**Substances  
Spontaneous Flammable  
Adhesive**

*Adesivo Trasporto Sostanze  
Infiammabili Spontanee*



ARTICLE	L	H	KG	
T99604	300	300	0,02	24

**Transport  
Explosives Class 1.3  
Adhesive**

*Adesivo Trasporto  
Esplosivi Classe 1.3*



ARTICLE	L	H	KG	
T99616	300	300	0,02	24

**A.D.R. Kit**

*Kit A.D.R. Base*

ARTICOLO	L	H	P	KG	
KITADR1	500	450	330	8,80	1

- |                              |                                     |                            |                                    |
|------------------------------|-------------------------------------|----------------------------|------------------------------------|
| 1 Bag                        | 1 Borsa                             | 1 PVC Boots                | 1 Stivali in PVC                   |
| 1 Warning Jacket             | 1 Gilet Fluorescente                | 1 Eye Rinse Solution       | 1 Flacone Lavaggio Oculare         |
| 1 Torch                      | 1 Lampada Portatile                 | 1 Folding Non-Spark Shovel | 1 Pala Antiscintilla Pieghevole    |
| 2 Emergency Lamp             | 2 Lampade Crepuscolari              | 1 Tyvek Overall®           | 1 Tuta TYVEK®                      |
| 4 Battery for Emergency Lamp | 4 Batterie per Lampade Crepuscolari | 1 Partial Mask with Filter | 1 Maschera Semifacciale            |
| 1 Protective Glass           | 1 Occhiali Protettivi               | 1 Filter for Partial Mask  | 1 Filtro per Maschera Semifacciale |
| 1 Acid Proof Gloves          | 1 Guanti Antiacido                  |                            |                                    |



**Nylon Empty Bag  
for A.D.R.**

*Borsa Vuota per A.D.R.*



ARTICLE	L	H	P	KG	
T95090	520	450	330	1,10	100

**Homologated  
Warning Jacket**

*Gilet Alta Visibilità Omologato*



ARTICLE	TG	KG	
34902	XL	0,15	1

**Tyvek Overall with Hood**

*Tuta monouso Tyvek*



ARTICLE	TG	KG	
30236XL	XL	0,17	1





## Acid Proof Gloves

Guanto Antiacido in Neoprene



ARTICLE	TG	KG	
MAPA405	10	0,08	1

The gloves are certified EN388-EN374.  
I guanti sono certificati EN388-EN374.

## PVC Protective Glasses

Occhiale Aearo di Protezione



ARTICLE	L	H	KG	
R223	170	70	0,06	1

## Acid-Proof PVC Boots

Stivale in PVC Antinfortunistico Antiacido



ARTICLE	H	TG	KG	
TT140045	390	45	2,62	1

## Eye Rinse Solution

Liquido per Lavaggi Oculari



ARTICLE	ML	KG	
T95502	500	0,60	1

**i** The bottle has a shaped spout for the eye.  
Il flacone ha l'apposito beccuccio sagomato per l'applicazione direttamente sull'occhio.

## Silicone Partial Mask Monofilter

Maschera Semifacciale in Silicone Monofiltro



ARTICLE	L	H	KG		
SGE46	Mask Maschera	140	130	0,05	1
R332	Filter Filtro	70	40	0,12	1

**i** The mask and the filters are certified.  
La maschera ed il filtro sono certificati.

## Full Face Mask with Filter

Maschera in Gomma Pieno Facciale con Filtro



ARTICLE	L	H	KG		
R309	Mask Maschera	180	260	0,15	1
R338	Filter Filtro	105	90	0,25	1

## Torch with Battery

Torcia Elettrica a 3 Led 2xAA



ARTICLE	L	H	KG	
T952051	190	70	0,24	1

## Non-Spark Led Lamp with Batteries

Lampada a Led Antiscintilla completa di batterie



ARTICLE	L	D	KG	
T95205	145	15	0,05	1

In compliance with the legislation CE: ATEX 2014/34/EU.  
Conforme alla normativa CE: ATEX 2014/34/EU.

## Emergency Lamp with Batteries

Lampada Crepuscolare con Pile



ARTICLE	L	H	KG		
T95201	Lamp Lampada	180	320	0,53	1
T95202	Batteries Pile	65	110	0,50	1



## Eye Rinse Solution

Liquido per Lavaggi Oculari



ARTICLE	ML	KG	
T95504	500	0,54	1

## Safety Helmet

Elmetto



ARTICLE	L	H	KG	
H060	290	145	0,35	1

## Folding Non-Spark Shovel

Pala Antiscintilla Pieghevole  
Manico Staccabile



ARTICLE	L	H	KG	
T95101/1	240	720	0,48	1

## Cover Sheet For Drains

Copritombino



ARTICLE	L	H	KG	
T95650	600	500	1,24	1

## Absorbent Powder

Polvere Assorbente



ARTICLE	L	H	KG	
95551	130	150	1,00	1

## Acid Proof Container

Contenitore Antiacido



ARTICLE	L	H	LT	KG	
T125131	270	560	25	1,26	1

## Homologated A.D.R. Ground Cable

Cavo di Massa A.D.R. Omologato



ARTICLE	L	H	KG	
R10660	950	35	1,50	1

## Red/White Stripe

Nastro Bianco/Rosso



ARTICLE	H	D	MT	KG	
T95253	70	110	200	0,42	1

## Warning Triangle

Triangolo Base Ferro



ARTICLE	L	H	KG	
65798	420	445	0,62	1

**i** A.D.R. Ground Cable, supplied with Certificate of Conformity.  
Cavo di massa A.D.R. Omologato fornito con Certificato di Conformità.



## Big Traffic Cone Holder

Portabirilli Grande



ARTICLE	L	H	P	KG	
C09Z4	305	750	625	6,50	1

## Small Traffic Cone Holder

Portabirilli Piccolo



ARTICLE	L	H	P	KG	
C09Z5	232	530	232	3,10	1

## PVC Traffic Cone

Cono Rifrangente in PVC



ARTICLE	L	H	KG	
T95255	220	300	0,36	1
T95252	260	500	0,59	1

## Small First Aid Kit

Cassetta Piccola Pronto Soccorso  
per 2 persone Normativa Allegato 2

ARTICLE	L	H	KG	
MEDIC1	290	200	1,20	1



- 4 Disposable sterile gloves (2 pairs)
- 1 125 ml vial of povidone 10% iodine cutaneous solution
- 1 250 ml bottle of physiological solution (sodium chloride 0.9%)
- 1 18x40 sterile gauze compresses in single pouches
- 3 10x10 sterile gauze compresses in single pouches
- 1 Disposable sterile dressing tweezers
- 1 Pack of hydrophilic cotton
- 1 Pack of ready-to-use patches of various sizes
- 1 Roll of plaster 2,5 cm high
- 1 Roll of edged bandage 10 cm high
- 1 A pair of scissors
- 1 A tourniquet
- 1 Ready-to-use ice pack
- 1 Disposable bags for the collection of medical waste
- 1 Instructions on how to use the aforementioned devices and to provide first aid while waiting for the emergency service

- 4 Guanti sterili monouso (2 paia)
- 1 Flacone di soluzione cutanea di iodopovidone al 10% di iodio da 125 ml
- 1 Flacone di soluzione fisiologica (sodio cloruro 0,9%) da 250 ml
- 1 Compresse di garza sterile 18x40 in buste singole
- 3 Compresse di garza sterile 10x10 in buste singole
- 1 Pinzetta da medicazione sterile monouso
- 1 Confezione di cotone idrofilo
- 1 Confezione di cerotti di varie misure pronti all'uso
- 1 Rotolo di cerotto alto cm 2,5
- 1 Rotolo di benda orlata alta cm 10
- 1 Un paio di forbici
- 1 Un laccio emostatico
- 1 Confezione di ghiaccio pronto uso
- 1 Sacchetto monouso per la raccolta di rifiuti sanitari
- 1 Istruzioni sul modo di usare i presidi suddetti e di prestare i primi soccorsi in attesa del servizio di emergenza

## First Aid Kit Over 2 Person

Cassetta Pronto Soccorso  
per più di 2 persone  
Normativa Allegato 1

ARTICLE	L	H	KG	
MEDIC2	395	270	5,40	1



- 10 Disposable sterile gloves (5 pairs)
- 1 Splash guard
- 1 1 liter vial of povidone 10% iodine cutaneous solution
- 3 500 ml bottles of physiological solution (sodium chloride - 0.9%)
- 10 10x10 sterile gauze compresses in single pouches
- 2 18x40 sterile gauze compresses in single pouches
- 2 Disposable sterile drapes
- 2 Disposable sterile dressing tweezers
- 1 Medium size elastic net pack
- 1 Pack of hydrophilic cotton
- 2 Packs of plasters of various sizes ready to use
- 2 Rolls of plaster cm high. 2,5
- 1 A pair of scissors
- 3 Tourniquets
- 2 Ready-to-use ice
- 2 Disposable bags for the collection of medical waste
- 1 Thermometer
- 1 Sphygmomanometer for measuring blood pressure
- 1 Instructions on how to use the aforementioned devices and to provide first aid while waiting for the emergency service

- 10 Guanti sterili monouso (5 paia)
- 1 Visiera paraschizzi
- 1 Flacone di soluzione cutanea di iodopovidone al 10% di iodio da 1 litro
- 3 Flaconi di soluzione fisiologica (sodio cloruro - 0,9%) da 500 ml
- 10 Compresse di garza sterile 10x10 in buste singole
- 2 Compresse di garza sterile 18 x 40 in buste singole
- 2 Teli sterili monouso
- 2 Pinzette da medicazione sterili monouso
- 1 Confezione di rete elastica di misura media
- 1 Confezione di cotone idrofilo
- 2 Confezioni di cerotti di varie misure pronti all'uso
- 2 Rotoli di cerotto alto cm. 2,5
- 1 Un paio di forbici
- 3 Lacci emostatici
- 2 Ghiaccio pronto uso
- 2 Sacchetti monouso per la raccolta di rifiuti sanitari
- 1 Termometro
- 1 Apparecchio per la misurazione della pressione arteriosa
- 1 Istruzioni sul modo di usare i presidi suddetti e di prestare i primi soccorsi in attesa del servizio di emergenza

20

TRUCK

Via Ferrara, 10 - 53045 Montepulciano Stazione (SI)  
ITALY - Tel. +39.0578.708.709

[www.trucksrl.it](http://www.trucksrl.it) - [info@trucksrl.it](mailto:info@trucksrl.it)